

Assistive Control System Using Continuous Myoelectric Signal in Robot-Aided Arm Training for Patients After Stroke

Rong Song, Kai-yu Tong, *Senior Member, IEEE*, Xiaoling Hu, and Le Li

Abstract—In some stroke rehabilitation programs, robotic systems have been used to aid the patient to train. In this study, a myoelectrically controlled robotic system with 1 degree-of-freedom was developed to assist elbow training in a horizontal plane with intention involvement for people after stroke. The system could provide continuous assistance in extension torque, which was proportional to the amplitude of the subject's electromyographic (EMG) signal from the triceps, and could provide resistive torques during movement. This study investigated the system's effect on restoring the upper limb functions of eight subjects after chronic stroke in a twenty-session rehabilitation training program. In each session, there were 18 trials comprising different combinations of assistive and resistive torques and an evaluation trial. Each trial consisted of five cycles of repetitive elbow flexion and extension between 90° and 0° at a constant velocity of 10°/s. With the assistive extension torque, subjects could reach a more extended position in the first session. After 20 sessions of training, there were statistically significant improvements in the modified Ashworth scale, Fugl-Meyer scale for shoulder and elbow, motor status scale, elbow extension range, muscle strength, and root mean square error between actual elbow angle and target angle. The results showed that the twenty-session training program improved upper limb functions.

Index Terms—Arm tracking, myoelectric control, robot-assisted rehabilitation, stroke.

I. INTRODUCTION

STROKE is a leading cause of death and disability in many countries [1]. Patients after stroke are often reported to have a lower quality of life (QOL), due to stroke-induced disabilities, than normal subjects of similar age [2], [3]. Poststroke depression is also reported in patients after stroke with impaired QOL [4]. It is important for them, their families, and society that they are helped in restoring their lost motor functions to improve their QOL.

Rehabilitation training has been shown to have a positive effect on neurological restoration of limb functions [5]. Conventionally, rehabilitation training can be conducted by therapists in a one-on-one manual mode in a hospital. In recent years, robotic

systems have been developed as useful complementary units to therapists to manipulate a paretic arm [6]–[12]. MIT-Manus is a robotic system designed for upper limb stroke rehabilitation [5], [8]. The key feature of MIT-MANUS is its impedance control, which can keep a compliant trajectory under perturbation. Its therapeutic effect has been confirmed through a series of experiments [12]–[14]. Mirror-image movement enabler (MIME) is 3-D space [10], [15]. Patients can use their unaffected side to control their affected side to practice mirror-image movement by a bimanual position feedback strategy. Daily therapy with MIME in chronic hemiparetic subjects showed a significant improvement in their muscle strength and motion function [15]. ARM Guide was designed for both training and evaluation of upper limb reaching functions in a linear trajectory [9], [16]. Colombo *et al.* also designed a wrist manipulator with 1 degree-of-freedom (DOF) and an elbow-shoulder manipulator with 2 DOF for rehabilitation of upper limb movements. They used admittance control to reduce the inertia and facilitate the movement [6]. Recent developments involving rehabilitation robots have worked toward interactive control, with the robotic systems reacting to inputs from the subject [11].

Myoelectric control is related to the subject's intention and can be used as a control variable since surface electromyographic (EMG) signals reflect the activities of the muscles. EMG signals have been frequently applied in the control of prosthetics for more than forty years and can be classified in “on-off” control [21], proportional control [22], and a more complex form, for distinguishing different kinds of motion [19], [20]. Myoelectric control has also been reported for the control of functional electrical stimulation (FES) systems in rehabilitation [18], [23], [24], since voluntary physical exercise is important to promote the recovery of brain function in patients after stroke [17]. Recently, many researchers have used EMG signals to continuously control exoskeleton robots that can be worn by the human subject as an assistive device. The researchers used EMG signals of selective muscles to estimate the joint torque, and applied the assistive torque to the joint to provide additional power. In such studies, the system is under the control of the subject's intention, functioning like additional muscle groups [26]–[29]. However, Rosen *et al.* only applied the robotic system using continuous EMG control on normal subjects to share the loading [26], [27]. Cheng *et al.* applied their system to provide continuous assistive torque for subjects after stroke [28]. Their systems could improve the elbow torque capability of unimpaired subjects and of subjects after stroke within their voluntary range-of-motion, respectively. However,

Manuscript received August 29, 2007; revised March 18, 2008; accepted March 26, 2008. First published June 3, 2008; last published August 13, 2008 (projected). This work was supported in part by the Research Grants Council of the Hong Kong Special Administrative Region, China under Grant PolyU 5271/05E.

The authors are with the Department of Health Technology and Informatics, The Hong Kong Polytechnic University, Kowloon, Hong Kong (e-mail: rong-song@tsinghua.org.cn; k.y.tong@polyu.edu.hk; xiaoling.hu@polyu.edu.hk; htlieli@inet.polyu.edu.hk).

Color versions of one or more of the figures in this paper are available online at <http://ieeexplore.ieee.org>.

Digital Object Identifier 10.1109/TNSRE.2008.926707

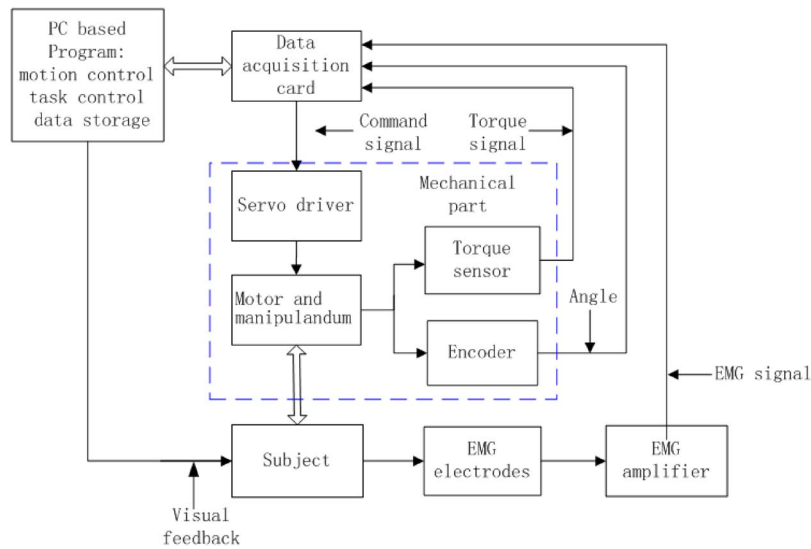

Fig. 1. Architecture of the myoelectrically controlled robotic system.

it has not been reported if those kinds of devices could help subjects after stroke to perform rehabilitation beyond their voluntary range, and if those kinds of devices could be applied as a rehabilitation robot in a robot-aided therapy. The use of myoelectrically controlled robot-aided therapy for subjects after stroke has so far been studied in an EMG-triggered “on-off” control [25]. A sensorimotor integration theory has been applied to explain that the voluntary efferent output as well as the afferent sensor input were helpful to promote the reorganization of the brain [18]. Though the subject could only control the initial action of the external robotic system in the EMG-triggered “on-off” control, the robotic system would afterward operate with a predefined trajectory or action for a period of time, which had no interaction with the EMG signal during this period until the time allowed for the next trigger event. The additional intention control through continuous myoelectric control could provide more interaction during the whole motion, which might be beneficial in promoting the restoration of motor functions for patients after stroke. Our pilot study had reported promising therapeutic effects of a myoelectrically controlled robotic system in improving muscle strength and extension range in three subjects [30]. In this present study, eight subjects after stroke were recruited for statistical analysis to evaluate the effects of training with a continuous myoelectrically controlled robotic system. The outcome parameters included clinical scales (modified Ashworth scale, Fugl–Meyer scale, and motor status scale), muscle strength, range-of-motion, and robot-measured parameters. If there was no EMG activation from the subject, the robotic system would not generate an assistive torque. Therefore, all of the subjects were encouraged to use their residual voluntary EMG to actively participate in the training.

II. METHODS

A. System

The structure of the myoelectrically controlled robotic system is shown in Fig. 1 and consists of a personal computer

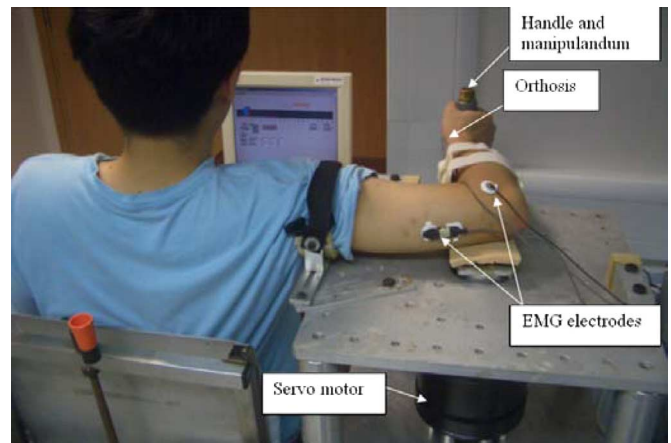

Fig. 2. Diagram of the myoelectrically controlled robotic system.

(PC), a PC-based data acquisition device, an actuated mechanical part, and an EMG amplifier. After being captured through EMG electrodes (Noraxon, Scottsdale, AZ) and amplified by the EMG amplifier, the EMG signals together with the torque signal and the angle signal were inputted through the data acquisition (DAQ) card (PCI 6036E, National Instruments, Austin, TX) into the computer. The software has three functions: 1) it generated a control signal and controlled the motor to provide mechanical help through the DAQ card, 2) it provided a task to guide the subject and provided real-time visual feedback to the subject during the task, displaying both the target and the actual elbow joint angle on a computer screen placed in front of the subject, and 3) it stored the EMG, torque and angle signals for further analysis. The mechanical part of a robotic manipulator with 1 DOF was designed and fabricated for assisting the movement of elbow flexion and extension (Fig. 2). The two layers of aluminum plates were connected by four aluminum pillars. The lower plate was fixed to a table. The direct drive (DDR) brushless AC servo motor (DM 1045B, Yokogawa, Japan) was fixed to the lower plate. The motor was connected to a torque sensor (AKC-205, 701st Research Institute of China Aerospace

Science and Technology Corporation, China). The other end of the torque sensor was connected to a manipulandum. An orthosis with a semicircular cross section was attached to the manipulandum. The subject's forearm was placed inside the orthosis and straps were used to secure the forearm in place. The manipulandum had a handle that the subject grasped for the experiment. The position of the handle was adjustable according to the length of the subject's forearm. The upper arm was also fastened by a strap to a support mounted on the upper aluminum plate. The orthosis and manipulandum could guide the forearm to rotate with an axis of rotation in line with the motor and the torque sensor. The torque sensor could measure the interaction torque between the manipulandum and the servo motor. The DDR motor was driven by a servo driver (SD1045B, Yokogawa, Japan). An optical incremental shaft encoder was attached to the motor shaft for measuring the joint angle.

For safety reasons, three steps were taken to protect each subject during the experiment. First, two mechanical stops were used to limit the rotation range of the motor. Second, the software program limited the output torque to a preset range of -5 to 5 Nm, and the operation would be stopped if the motor exceeded this range. Third, an emergency stop could be pressed by the subject to break the power supply to the servo motor if needed.

B. EMG-Signal Processing Procedures

Abnormal biceps activation during elbow extension is often found in subjects after stroke, reflecting the impairment of their ability to selectively activate flexors and extensors [44]. Using this finding, the present study avoided using the subjects' elbow flexors for the control signals during elbow extension in order to minimize the interference of abnormal firing patterns from the biceps in the movement. The EMG signal from medial triceps brachii of the affected arm was used as the control signal for proportional control of the robotic system.

The EMG signals were amplified with a custom-made EMG system using an instrumentation amplifier (INA126, Texas Instruments, Dallas, TX). The signals were amplified with a gain of 1000 and were band-pass filtered in a 10–400-Hz band. The EMG signals were all sampled at 1000 Hz. The envelope of the EMG signals was obtained after the signals were full-wave rectified and filtered with a moving average window (100 ms).

The processed triceps EMG signals w_j were then normalized to the range 0–1 for NEMG_j , as in the following [28]:

$$\text{NEMG}_j = \frac{w_j - w_r}{w_{\text{MIVE}} - w_r} \quad (1)$$

where w_r was the amplitude of the processed triceps EMG signal at rest, and w_{MIVE} was the maximum amplitude of the processed triceps EMG signal during maximum isometric voluntary extension (MIVE) at 90° elbow flexion. The assistive torque T_{assist} was estimated based on the normalized EMG signals, as in the following:

$$T_{\text{assist}} = G * T_{\text{MIVE}} * \text{NEMG}_j \quad (2)$$

where G was the gain for EMG to torque conversion. The EMG-torque gain was set at 0%, 50%, and 100% in this study. T_{MIVE}

was the MIVE torque. The resultant torque T_{res} is shown in the following:

$$T_{\text{res}} = T_{\text{assist}} + T_{\text{resist}} \quad (3)$$

where $T_{\text{resist}} = \lambda T_{\text{MVC}} \cdot T_{\text{MVC}}$ was the MIVE torque during elbow extension and the maximum isometric voluntary flexion (MIVF) torque during elbow flexion. λ was a coefficient of the resistive torque, the level of which ranged from 0%, 10%, and 20%. The range of the EMG-torque gain G (0%–100%) and the coefficient of the resistive torque λ (0%–20%) were determined in a pilot experiment with twelve subjects after chronic stroke and based on the performance of their movements. The 12 subjects could manipulate the system easily, with the above-mentioned parameters during elbow flexion and extension in the robotic system.

C. Experiment Setup

Eight of the 12 subjects in the pilot study (seven males, one female) were recruited for this present study consisting of a twenty-session training program, based on their availability to participate in the 20 sessions of training. The mean age of the eight subjects was 50 ± 9 years, and they ranged from 39 to 62 years. Each subject was to undergo 20 sessions of training, with three to five sessions conducted each week over six consecutive weeks. The criteria for recruiting the subjects included the following: 1) there should be at least six months after unilateral stroke in order to minimize the effect of spontaneous recovery [49] (the mean duration from stroke onset was 5.7 ± 4.2 years, ranging from 10 months to 13 years), 2) the subjects should not have visuospatial, cognitive, or attention deficits that would prevent them from following instructions or performing the experimental procedures, and 3) the subjects should have a measurable EMG signal from medial triceps brachii (the processed EMG signal after the moving window should be at least twice as large than that at rest). This study was approved by the Human Subject Ethics Sub-Committee of The Hong Kong Polytechnic University. Prior to the experiment, the subjects were explained the experimental procedures and duration before they signed the consent forms.

During the experiment, the subject was seated beside the system. The shoulder was in 90° abduction. The affected forearm was attached to the manipulandum, and the subject was asked to grasp the handle of the manipulandum. The orthosis and strap were used to secure the forearm in position. A computer screen was placed in front of the subject to provide visual information of the target angle for the subject to follow, and the subject was instructed to complete the following tasks.

- 1) The MIVE and MIVF torques were measured for the affected elbow flexors and extensors when the elbow was positioned at a 90° angle in the horizontal plane, since the maximum MIVE and MIVF torques across all elbow angles could be achieved at nearly 90° [47]. The EMG signals during MIVE were captured to normalize the EMG signal of the triceps. Three trials were performed for 5 s each, and the maximum values of the torque and EMG signal were used.

2) The subject was asked to perform a repetitive arm movement that began with the elbow at 90° . The computer screen placed in front of the subject displayed a pointer for the target angle and a pointer for the actual elbow joint angle. The subject was to try to control the elbow movement to track and match the target pointer that was displayed in real time. In each trial, after a 3-s delay from the beginning of the time that the target pointer appeared ready on the screen so that the subject was able to get ready, the target pointer would move from 90° to 0° at a constant velocity of $10^\circ/\text{s}$, which was deemed beforehand as a reasonable speed for most of the subjects to follow, and the subject was to extend his/her affected elbow to track using the myoelectrically controlled system. Then the target pointer would pause at 0° for 3 s. Following this, the target pointer would come back from 0° – 90° at a constant speed of $10^\circ/\text{s}$ to complete one cycle, and the subject flexed his/her affected elbow with the myoelectrically controlled robotic system to track the target pointer back to 90° . Five cycles were conducted in each trial, and it took 2 min to complete one trial. During elbow extension, the robotic system continuously generated an assistive torque that was proportional to the amplitude of the processed triceps EMG signal in order to assist elbow movement, together with a constant resistive torque that was a percentage of the MIVE torque. The EMG level and maximum isometric voluntary torque could be changed during the 20 sessions of training. We used the maximum isometric voluntary torque to find the EMG activation level in each training session, and the system could keep the agonist muscle training at a certain level of muscle activation throughout all of the training sessions. The assistive torque and resistive torque provided by the system were based on (1)–(3). During elbow flexion, there was only a constant resistive torque that was a percentage of the MIVF torque, and no assistive torque was applied. This was because elbow flexion could be more easily performed than elbow extension in the affected arm of subjects after stroke. All eight subjects could flex their elbows back to 90° without the assistance. The percentages of resistance for extension and flexion were the same. Fig. 3 shows the relationship between the target angle, EMG-torque gain, coefficient of the resistive torque (λ), raw EMG signal of triceps, and resultant torque from the motor during a cycle. In a trial, λ and the EMG-torque gain were constants. If the subject could not extend his/her forearm to track the target pointer, it was suggested to the subject that he/she stop at his/her largest extended position and wait for the target pointer to come back and track it again from that point. There were 18 trials in a training session, comprising different combinations of EMG-torque gain (50% and 100%) and λ (0%, 10%, and 20%), resulting in three trials of each combination (shown in Fig. 4). There was also an evaluation trial without any assistive and resistive torque from the robotic system ($G = 0\%$ and $\lambda = 0\%$) conducted in each session immediately before the experimental trials commenced. The evaluation trial was used to evaluate the function improvement of the affected elbow throughout

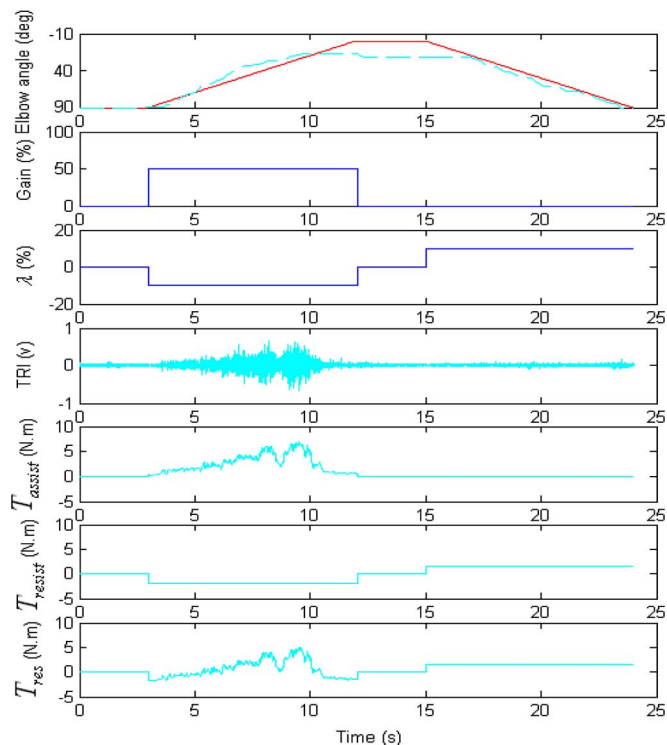

Fig. 3. Target angle, actual elbow angle, EMG-torque gain ($G = 50\%$), coefficient of resistive torque ($\lambda = 10\%$), raw EMG of triceps, assistive torque, resistive torque, and resultant torque from the robotic system during one cycle. The negative value of λ was the resistive torque during extension and the positive value was the resistive torque during flexion. There was no resistive torque during the resting periods, when λ was equal to zero. During elbow extension, the robotic system would generate an assistive torque and a constant resistive torque; during elbow flexion, there was only a constant resistive torque.

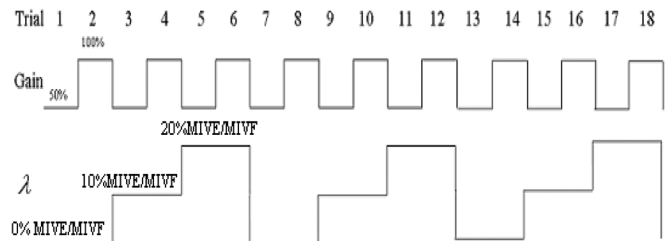

Fig. 4. Experiment protocol for each of the 20 sessions of the rehabilitation training program. The numbers at the top of the diagram show the sequence of the trials in each session. EMG-torque gains were provided at two levels (50% and 100%). Coefficient of the resistive torque, λ , during elbow extension and elbow flexion were provided at three levels (0%, 10%, and 20%).

the 20 sessions of training. There was a 1 min resting period after each trial, and the total training time in one session was about 1 h. In each trial, the elbow angle and the target signal were recorded at a sampling frequency of 100 Hz.

D. Evaluation Parameters and Statistical Analysis

Clinical scales were used to evaluate the upper limb functions before and after the 20-session training program. These scales included the Fugl–Meyer scale and the motor status scale (MSS) for the evaluation of motor function [31]–[33], and the modified Ashworth scale for the evaluation of muscle tone at the elbow joint [34], [35]. In each training session, the robotic system

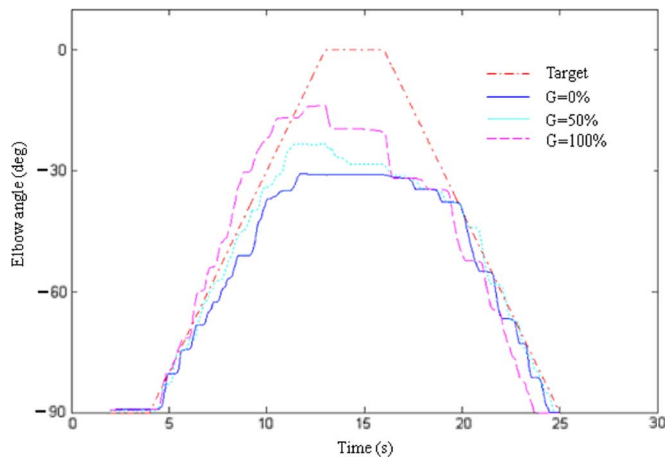

Fig. 5. Trajectories of a subject after stroke with assistance from the robotic system at different EMG-torque gains during voluntary elbow tracking when there was no resistive torque.

also provided robot-measured parameters to indicate the function improvement, which included the active range-of-motion, maximum voluntary torque, and accuracy during the tracking. Extension range was used to indicate the improvement of the active range-of-motion, which was defined as the maximum angular displacement of elbow extension from 90° . The MIVF and MIVE torques were used to reflect muscle strength. Moreover, the root mean squared error (RMSE) between the elbow angle and the target angle in the evaluation trial of each session was also used as a performance indicator of tracking accuracy. Due to a large variation with non-Gaussian distribution of the motor performance among subjects after stroke, a Wilcoxon signed rank test was used in the present study to verify the statistical significance of change in the extension range among different EMG-torque gains, and changes in the variables between pre-training and posttraining. The significant level was set at 0.05. All statistical work was performed using SPSS 14 (SPSS Inc., Chicago, IL).

III. RESULTS

Fig. 5 shows typical trajectories of a subject at different EMG-torque gains in the first session of the training program. The subject could extend his/her affected elbow to a more extended position with the continuous assistance of the robotic system as a result of his/her EMG signal. With the increase in EMG-torque gain from 50% to 100%, the extension range also increased. Fig. 6 shows the group mean extension range of all subjects at different EMG-torque gains in the first session of training when there was no resistive torque. There was a significant increase in the extension range for all subjects with the assistance of the myoelectrically controlled robotic system ($G = 50\%$ and 100%), compared with that without the assistance of the system ($p < 0.05$ for both comparisons). There was an increase in extension range when the EMG-torque gain increased from 50% to 100%, but the results did not show significant difference ($p = 0.16$). The absence of significant difference might be due to the limited room for further improvement in the extension range from 50% to 100% and large intersubject difference

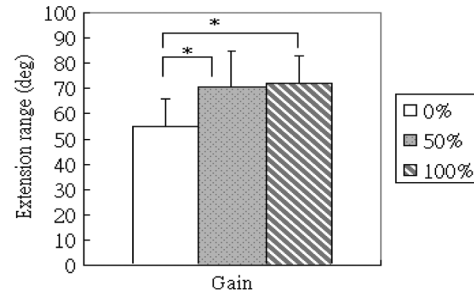

Fig. 6. Group mean extension range of all subjects after stroke at different EMG-torque gains in the first training session when there was no resistive torque. Vertical bars represent the standard deviation.

in the extension range. Fig. 7 plots the change of elbow trajectories in sessions 1, 6, 11, and 16 of a single subject. Fig. 8 shows the group mean extension range with ($G = 100\%$, $\lambda = 0\%$) and without ($G = 0\%$, $\lambda = 0\%$) the assistance of the system in the 20 consecutive sessions. A continuous increase in extension ranges could be found in trials both with and without the assistance of the system. Extension ranges with the assistance of the system were significantly larger than that without the assistance of the system in all 20 sessions ($p < 0.05$).

The results demonstrate that the robotic system with continuous myoelectric control could help subjects after stroke perform rehabilitation training in extension ranges that could not be achieved without the assistive torque. Fig. 9 presents the group mean RMSE between the target angle and the actual elbow angle in the evaluation trials of the 20 consecutive training sessions. The RMSE dropped abruptly during the first eight of the 20 training sessions, and there was little change during the last several sessions.

The torque signals measured by the robotic system were also used to evaluate the improvement in muscle strength during the rehabilitation training. The group mean MIVE and MIVF torques of all subjects when the affected elbow was at 90° are shown in Fig. 10. Increases in the MIVE and MIVF torques were found during the rehabilitation training, indicating that the continuous assistance of the myoelectrically controlled robotic system had a positive effect in developing muscle strength. After the twenty-session training, there was an increase of 120.3% and 67.4% for the group mean MIVE and MIVF torques, respectively.

Table I summarizes the mean values \pm standard deviations of clinical variables and robot-measured parameters, their difference, and the p value of the comparison between pre- and post-twenty-session training. There was a statistically significant decrease in the modified Ashworth score after the twenty-session training that reflected the improvement in muscle tone in the affected elbow. There were significant increases in the Fugl-Meyer score for the shoulder and elbow and MSS, which reflected an improvement in upper limb motor functions, and there was no significant increase in the Fugl-Meyer score for the wrist and hand. The RMSE between the measured elbow angle and the target angle showed a statistically significant decrease, and the extension range showed a statistically significant increase. There was also a statistically significant increase in the MIVF and MIVE torques when the elbow angle was at 90° .

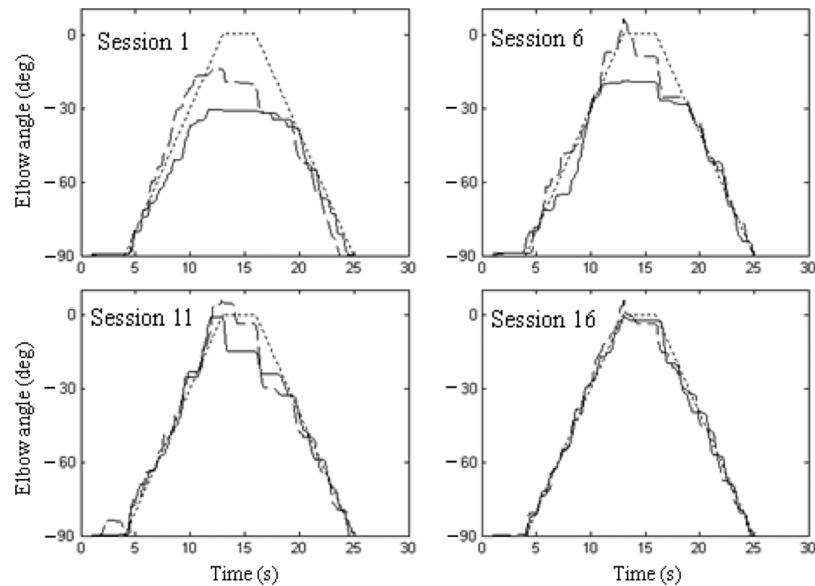

Fig. 7. Change of elbow trajectories of a subject after stroke in sessions 1, 6, 11, and 16 when there was no assistive torque ($G = 0\%$) and assistive torque ($G = 100\%$) (dotted line: the target trajectory; solid line: $G = 0\%$; dashed line: $G = 100\%$).

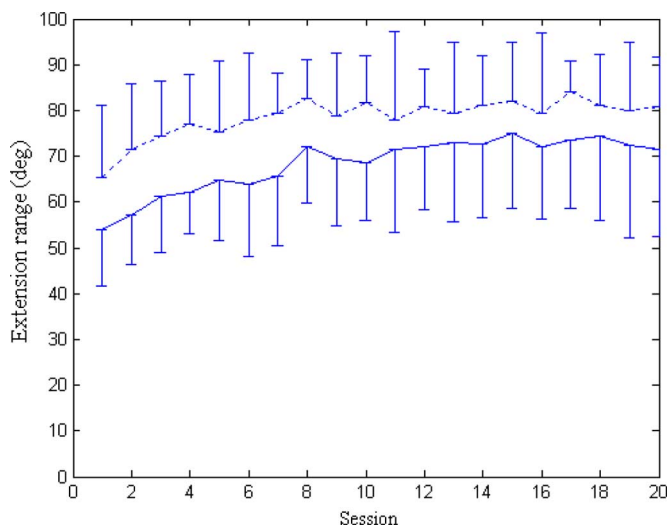

Fig. 8. Group mean extension range of the actual elbow trajectory with (dotted line: $G = 100\%$, $\lambda = 0\%$), and without (solid line: $G = 0\%$, $\lambda = 0\%$) assistance from the robotic system of all subjects after stroke in the 20 training sessions. The vertical bars represent the standard deviation.

IV. DISCUSSION

Assistive and Resistive Torque Effects: Although there are many studies that have reported that using an EMG-triggered FES system has a positive effect on restoring limb function, a myoelectrically controlled robotic system has often been applied as an assistive device rather than as a therapeutic device [26]–[28]. Stein *et al.* reported an electromyography-controlled exoskeletal upper-limb-powered orthosis for exercise training after stroke [36], but clinical scales were the only parameters investigated in their study. This present study investigated the therapeutic effect of robot-assisted rehabilitation using continuous myoelectric control in terms of clinical scales as well as robot-measured parameters. Our results showed that the robotic system might assist subjects after stroke to extend their affected arm to a more extended position for training than they could through their own

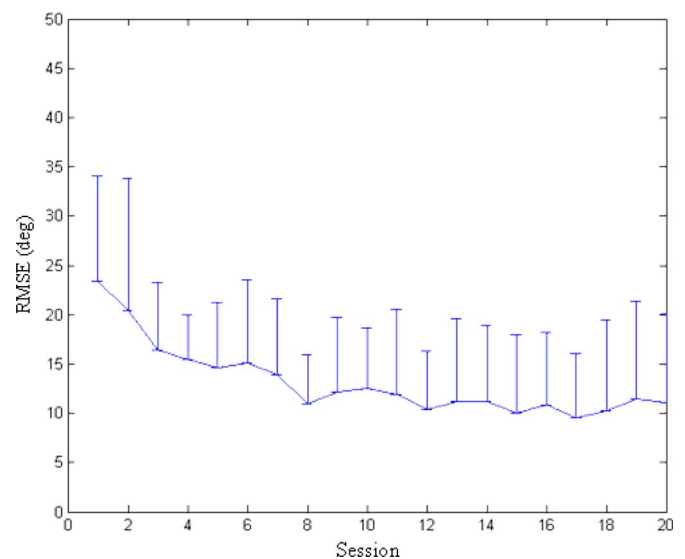

Fig. 9. Group mean RMSE between the target trajectory and the actual elbow trajectory of all subjects after stroke in the 20 training sessions. Vertical bars represent the standard deviation.

voluntary efforts. Ada *et al.* suggested that the training of muscles at their shortened lengths was more effective in developing muscle strength in patients after stroke as they have selective muscle weakness at shortened ranges [37], [38]. However, it is difficult or even impossible for such patients to reach an extended elbow position due to contracture [45], spasticity [46] or muscle weakness [38], [47]. The assistive function of the myoelectrically controlled robotic system could enable patients after stroke to perform voluntary training at a more extended position, as shown in Fig. 8. The improvements in Fugl–Meyer score for the shoulder and elbow, MSS, and modified Ashworth score in the present study were comparable with that reported in others' work [6], [9], [36]. Colombo *et al.* investigated the therapeutic effect of robot-aided stroke rehabilitation on upper limb functions using admittance control. The improvement in extension range in our

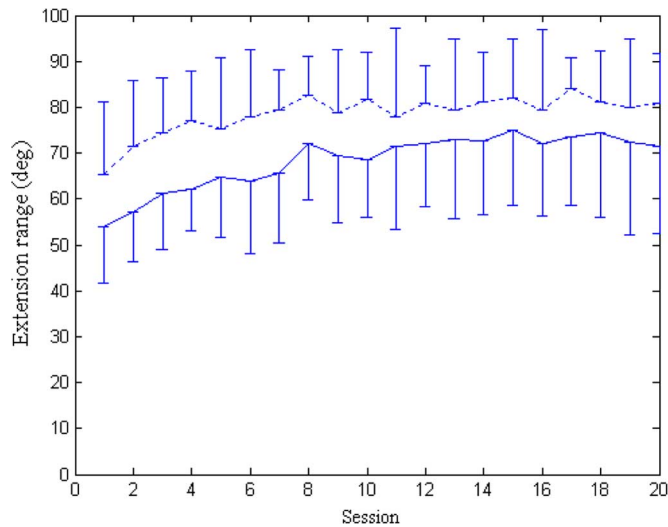

Fig. 10. Group mean MIVE (solid line) and MIVF (dotted line) torque of all subjects after stroke in the 20 training sessions. The vertical bars represent the standard deviation.

TABLE I
VALUES OF CLINICAL SCALES AND ROBOT-MEASURED VARIABLES PRE- AND POST-TWENTY-SESSION TRAINING PROGRAM FOR ALL SUBJECTS AFTER STROKE, IN WHICH S/E = SHOULDER AND ELBOW, W/H = WRIST AND HAND (*, $p < 0.05$)

Parameter	PRE (mean \pm s.d.)	POST (mean \pm s.d.)	POST- PRE (mean \pm s.d.)	p
Motor status scale (0-40)	16.50 \pm 3.92	19.40 \pm 4.65	2.90 \pm 2.54	0.03*
Fugl-Meyer scale S/E (0-42)	13.50 \pm 2.14	16.00 \pm 2.00	2.50 \pm 1.85	0.02*
Fugl-Meyer scale W/H (0-24)	5.63 \pm 2.77	7.25 \pm 1.58	1.63 \pm 2.20	0.09
Modified Ashworth scale (0-4)	1.63 \pm 0.64	1.19 \pm 0.37	-0.44 \pm 0.42	0.04*
Extension range (0-90 deg)	53.90 \pm 12.2	71.54 \pm 19.0	17.64 \pm 14.7	0.03*
RMSE (deg)	23.36 \pm 10.7	11.12 \pm 9.00	12.24 \pm 10.5	0.02*
MIVE torque (N.m)	10.98 \pm 6.75	24.19 \pm 9.92	13.22 \pm 5.72	0.02*
MIVF torque (N.m)	17.18 \pm 8.96	28.77 \pm 7.25	11.58 \pm 6.47	0.02*

study is larger than that reported in Colombo *et al.*'s study [6], which might be due to the contribution of myoelectric control and voluntary training in the extended range through the aid of assistive torque. The improvement in extension range might also relate to the increase in muscle strength shown in Fig. 10 and the decrease in muscle cocontraction [39]. The improvement of Fugl-Meyer score for the wrist was not found to be significant, which may be due to the rehabilitation training being conducted on the elbow joint only.

The clinical effect of resistive torque is still controversial, with some studies showing that there is no significant difference between robotic progressive-resistance therapy and active-assistance therapy [48], while other studies reported that high-intensity resistance training is effective for developing muscle strength [40], [41]. In this present study, a resistive torque was applied to keep agonist muscle activation at a level that could

occur in daily activities rather than in free movement without any load or no interaction with other objects. Under a condition of only resistive torque and no assistive torque, the system might affect the range-of-motion and the subject would only be trained at the joint within a more limited range in which muscle had sufficient strength against the resistive torque. The combination of assistive torque and resistive torque in this present study would help subjects after stroke to perform resistance training within a larger range-of-motion. The results showed increases in muscle strength of the elbow flexor and elbow extensor, and improvements in the range-of-motion after the twenty-session training program. The RMSE shows the relationship between the target and actual trajectories. The RMSE correlated with the extension range and also correlated with the motor control ability of the subject. During the first eight sessions of the training program, the extension range showed significant improvement, which caused a larger decrease in the RMSE.

Interactive Control: Although passive movements have been shown to have beneficial effects on restoring upper limb functions [42], rehabilitation training with the subject's intention input, such as interactive control, is preferred [43] and widely applied in current rehabilitation robots. The voluntary efferent output and the afferent sensor input form a sensorimotor cycle, which might promote motor relearning in subjects after stroke [18]. Impedance control has been implemented in MIT-MANUS to ensure a compliant trajectory, and the output torque is based on the patient's position error from the desired position. Admittance control in Colombo *et al.*'s robotic system could generate an angular displacement in response to a patient's torque [6]. Cozens *et al.* proposed an assist feedback control scheme that could detect spasticity from acceleration and provide a ramp torque in the movement if the acceleration was beyond the preset value [43]. The amount of interaction from the above-mentioned robotic systems was based on the subject's performance. If a subject after stroke has limited movements with no measurable net torque or kinematic data at some positions, these systems would provide no interaction but passive movement. In EMG-triggered on-off control, there was no other direct relationship between the EMG signal and the assistance from the external supplemental device once the device was triggered [18], [25]. In addition, the system could not be triggered within the interval between two trigger events, which might limit the interaction between the external assistance and efferent output from the central nervous system. Our system in the present study provides a type of assistance driven by the myoelectric signal whenever the EMG signal is present, which might provide an alternative way for subjects to interact with the device. The subject needs to learn how to coordinate and control his/her muscle activation throughout the training. Therefore, continuous proportional myoelectric control might have an advantage in robot-aided stroke rehabilitation in that it provides more interaction during the whole motion. The assistance from the robotic system could help the subject to further extend the affected elbow.

Limitations and Future Work: The present study has some limitations in the following aspects: although positive effects had been found in the subjects after stroke after their twenty-session training program with a continuous myoelectrically controlled robotic system, the research suffered from the absence

of a control group. Thus, the improvements we found cannot be conclusively attributed to the continuous myoelectric control. In order to confirm the therapeutic effect of the continuous myoelectric control in robot-aided rehabilitation, further comparisons should be made with other robotic systems that use different control strategies, such as impedance control [5], [8] and admittance control [6], through a large-scale randomized control trial. Moreover, the effects of different combinations of assistive torque and resistive torque on motor recovery may also need further investigation.

V. CONCLUSION

The feasibility of robot-aided rehabilitation using continuous myoelectric control for subjects after stroke was investigated in this study. The myoelectrically controlled robotic system could provide continuous assistive torque in proportion to the amplitude of the subject's electromyographic signal from the triceps and enabled the subjects after stroke to perform training beyond their initial voluntary range-of-motion. After the twenty-session training program, the results showed improvements in upper limb functions in terms of clinical scales and robot-measured parameters, which imply the system's potential to be applied in stroke rehabilitation.

REFERENCES

- [1] J. Mackay and G. Mensah, *The Atlas of Heart Disease and Stroke*. Geneva, Switzerland: World Health Organization, 2004 [Online]. Available: http://www.who.int/cardiovascular_diseases/resources/atlas/en/
- [2] E. J. Jonkman, A. W. de Weerd, and N. L. H. Vrijens, "Quality of life after first ischemic stroke. longterm developments and correlations with changes in neurological deficits, mood and cognitive impairment," *Acta Neurol. Scand.*, vol. 98, pp. 169–175, 1998.
- [3] T. B. Wyller, J. Holmen, P. Laake, and K. Laake, "Correlates of subjective well-being in stroke patients," *Stroke*, vol. 29, pp. 363–367, 1998.
- [4] F. Angeleri, V. A. Angeleri, N. Foschi, S. Giaquinto, and S. Nolfi, "The influence of depression, social activity, and family stress on functional outcome after stroke," *Stroke*, vol. 24, pp. 1478–1483, 1993.
- [5] N. Hogan, H. I. Krebs, J. Charnnarong, P. Srikrishna, and A. Sharon, "MIT-Manus: A workstation for manual therapy and training," in *Proc. IEEE Int. Workshop Robot Human Commun.*, Tokyo, Japan, 1992, pp. 161–165.
- [6] R. Colombo, F. Pisano, S. Micera, A. Mazzone, C. Delconte, M. C. Carrozza, P. Dario, and G. Minuco, "Robotic techniques for upper limb evaluation and rehabilitation of stroke patients," *IEEE Trans. Neural Syst. Rehabil. Eng.*, vol. 13, no. 3, pp. 311–324, Sep. 2005.
- [7] S. Hesse, G. Schulte-Tiggens, M. Konrad, A. Bardeleben, and C. Werner, "Robot-assisted arm trainer for the passive and active practice of bilateral forearm and wrist movements in hemiparetic subjects," *Arch. Phys. Med. Rehabil.*, vol. 84, no. 6, pp. 915–920, Jun. 2003.
- [8] H. I. Krebs, N. Hogan, M. L. Aisen, and B. T. Volpe, "Robot-aided neurorehabilitation," *IEEE Trans. Rehabil. Eng.*, vol. 6, no. 1, pp. 75–87, Mar. 1998.
- [9] D. J. Reinkensmeyer, L. E. Kahn, M. Averbuch, A. N. McKenna-Cole, B. D. Schmit, and W. Z. Rymer, "Understanding and treating arm movement impairment after chronic brain injury: Progress with the arm guide," *J. Rehabil. Res. Develop.*, vol. 37, no. 6, pp. 653–662.
- [10] P. S. Lum, C. G. Burgar, and P. C. Shor, "Evidence for improved muscle activation patterns after retraining of reaching movements with the MIME robotic system in subjects with post-stroke hemiparesis," *IEEE Trans. Neural Syst. Rehabil. Eng.*, vol. 12, no. 2, pp. 186–194, Jun. 2004.
- [11] R. Riener, T. Nef, and G. Colombo, "Robot-aided neurorehabilitation of the upper extremities," *Med. Biol. Eng. Comput.*, vol. 43, pp. 2–10, 2005.
- [12] H. I. Krebs, B. T. Volpe, M. L. Aisen, and N. Hogan, "Increasing productivity and quality of care: Robot-Aided neuro-rehabilitation," *J. Rehabil. Res. Develop.*, vol. 37, no. 6, pp. 639–652, Nov./Dec. 2000.
- [13] B. T. Volpe, H. I. Krebs, N. Hogan, O. T. R. Edelstein, C. Diels, and M. Aisen, "A novel approach to stroke rehabilitation: Robot-aided sensorimotor stimulation," *Neurology*, vol. 54, no. 10, pp. 1938–1944, 2000.
- [14] M. L. Aisen, H. I. Krebs, N. Hogan, F. McDowell, and B. T. Volpe, "The effect of robot-assisted therapy and rehabilitative training on motor recovery following stroke," *Arch. Neurol.*, vol. 54, no. 4, pp. 443–446, 1997.
- [15] C. G. Burgar, P. S. Lum, P. C. Shor, and H. F. M. van der Loos, "Development of robots for rehabilitation therapy: The Palo Alto VA/Stanford experience," *J. Rehabil. Res. Develop.*, vol. 37, no. 6, pp. 663–673, Nov./Dec. 2000.
- [16] D. J. Reinkensmeyer, J. P. A. Dewald, and W. Z. Rymer, "Guidance-based quantification of arm impairment following brain injury: A pilot study," *IEEE Trans. Rehabil. Eng.*, vol. 7, no. 1, pp. 1–11, Mar. 1999.
- [17] M. Hallett, "Recent advances in stroke rehabilitation," *Neurorehabil. Neural Repair*, vol. 16, no. 2, pp. 211–217, 2002.
- [18] J. Cauraugh, K. Light, S. Kim, M. Thigpen, and A. Behrman, "Chronic motor dysfunction after stroke: Recovering wrist and finger extension by electromyography-triggered neuromuscular stimulation," *Stroke*, vol. 31, no. 6, pp. 1360–1364, 2000.
- [19] K. Englehart, B. Hudgins, and P. A. Parker, "A wavelet-based continuous classification scheme for multifunction myoelectric control," *IEEE Trans. Biomed. Eng.*, vol. 48, no. 3, pp. 302–313, Mar. 2001.
- [20] B. Hudgins, P. Parker, and R. Scott, "A new strategy for multifunction myoelectric control," *IEEE Trans. Biomed. Eng.*, vol. 40, no. 1, pp. 82–94, Jan. 1993.
- [21] C. K. Battye, A. Nightingale, and J. Whillis, "The use of myo-electric currents in the operation of prostheses," *J. Bone Joint Surg.*, vol. 37B, pp. 506–510, 1955.
- [22] A. H. Bottomley, "Myo-electric control of powered prostheses," *J. Bone Joint Surg.*, vol. 47B, pp. 411–415, 1965.
- [23] D. Graupe, "EMG pattern analysis for patient-responsive control of FES in paraplegics for walker-supported walking," *IEEE Trans. Biomed. Eng.*, vol. 36, no. 7, pp. 711–719, Jul. 1989.
- [24] D. Graupe, K. H. Kohn, and S. P. Basseas, "Control of electrically-stimulated walking of paraplegics via above and below-lesion EMG signature identification," *IEEE Trans. Autom. Control*, vol. 34, no. 2, pp. 130–138, Feb. 1989.
- [25] L. Dipietro, M. Ferraro, J. J. Palazzolo, H. I. Krebs, B. T. Volpe, and N. Hogan, "Customized interactive robotic treatment for stroke: EMG-Triggered therapy," *IEEE Trans. Neural Syst. Rehabil. Eng.*, vol. 13, no. 3, pp. 325–334, Sep. 2005.
- [26] J. Rosen, M. Brand, M. B. Fuchs, and M. Arcan, "A myosignal-based powered exoskeleton system," *IEEE Trans. Syst. Man Cybern. A*, vol. 31, no. 3, pp. 210–212, May 2001.
- [27] J. Rosen, M. B. Fuchs, and M. Arcan, "Performances of hill-type and neural network muscle models—Towards a myosignal based exoskeleton," *Comput. Biomed. Res.*, vol. 32, pp. 415–439, 1999.
- [28] H. S. Cheng, M. S. Ju, and C. C. K. Lin, "Improving elbow torque output of stroke patients with assistive torque controlled by EMG signals," *J. Biomech. Eng.*, vol. 125, pp. 881–886, 2003.
- [29] S. Lee and Y. Sankai, "Power assist control for leg with HAL-3 based on virtual torque and impedance adjustment," in *Proc. IEEE Int. Conf. Syst., Man Cybern.*, Oct. 2002, vol. 4.
- [30] R. Song, K. Y. Tong, X. L. Hu, S. F. Tsang, and L. Li, "The therapeutic effects of myoelectrically controlled robotic system for persons after stroke—a pilot study," in *Int. Conf. IEEE Eng. Med. Biol. Soc.*, New York, 2006, pp. 4945–4948.
- [31] M. Ferraro, J. H. Demaio, and J. Krol, "Assessing the motor status score: A scale for the evaluation of motor outcomes in the patients after stroke," *Neurorehabil. Neural Repair*, vol. 16, pp. 283–289, 2002.
- [32] A. Fugl-Meyer, L. Jaasko, I. Leyman, S. Olsson, and S. Seglund, *Scand. J. Rehabil. Med.* "The post-stroke hemiplegic patient method for evaluation of physical performance," 1975, vol. 7, pp. 13–31.
- [33] A. Trombly and M. V. Radomski, *Occupational Therapy and Physical Dysfunction*. Philadelphia, PA: Lippincott Williams & Wilkins, 2002.
- [34] B. Ashworth, "Preliminary trial of carisoprodol in multiple sclerosis," *Practitioner*, vol. 192, pp. 540–542, 1964.
- [35] R. W. Bohannon and M. B. Smith, "Interrater reliability on a modified Ashworth scale of muscle spasticity," *Phys. Ther.*, vol. 67, pp. 206–207, 1987.
- [36] J. Stein, K. Narendran, J. McBean, K. Krebs, and R. Hughes, "Electromyography-controlled exoskeletal upper-limb-powered orthosis for exercise training after stroke," *Am. J. Phys. Med. Rehabil.*, vol. 86, no. 4, pp. 255–261, 2007.
- [37] L. Ada, C. G. Canning, and T. Dwyer, "Effect of muscle length on strength and dexterity after stroke," *Clin. Rehabil.*, vol. 14, no. 1, pp. 55–61, 2000.
- [38] L. Ada, C. G. Canning, and S. L. Low, "Stroke patients have selective muscle weakness in shortened range," *Brain*, vol. 126, no. 3, pp. 724–731, 2003.

- [39] X. L. Hu, K. Y. Tong, R. Song, V. S. Tsang, P. O. Leung, and L. Li, "Variation of muscle coactivation patterns in chronic stroke during robot-assisted elbow training," *Arch. Phys. Med. Rehabil.*, vol. 88, pp. 1022–1029, 2007.
- [40] A. Weiss, T. Suzuki, J. Bean, and R. A. Fielding, "High intensity strength training improves strength and functional performance after stroke," *Am. J. Phys. Med. Rehabil.*, vol. 79, no. 4, pp. 369–376, 2000.
- [41] M. M. Ouellette, N. K. LeBrasseur, J. F. Bean, E. Phillips, J. Stein, W. R. Frontera, and R. A. Fielding, "High-intensity resistance training improves muscle strength, self-reported function, and disability in long-term stroke survivors," *Stroke*, vol. 35, no. 6, pp. 1404–1409, 2004.
- [42] G. Nelles, W. Jentzen, M. Jueptner, S. Muller, and H. C. Diener, "Arm training induced brain plasticity in stroke studied with serial positron emission tomography," *NeuroImage*, vol. 13, pp. 1146–1154, 2001.
- [43] J. A. Cozens, "Robotic assistance of an active upper limb exercise in neurologically impaired patients," *IEEE Trans. Rehab. Eng.*, vol. 7, pp. 254–256, Jul. 1999.
- [44] C. G. Canning, L. Ada, and N. J. O'Dwyer, "Abnormal muscle activation characteristics associated with loss of dexterity after stroke," *J. Neurol. Sci.*, vol. 176, no. 1, pp. 45–56, 2000.
- [45] N. J. O'Dwyer, L. Ada, and P. D. Neilson, "Spasticity and muscle contracture following stroke," *Brain*, vol. 119, no. 5, pp. 1737–1749, 1996.
- [46] R. T. Katz and W. Z. Rymer, "Spastic hypertonia: Mechanisms and measurement," *Arch. Phys. Med. Rehabil.*, vol. 70, pp. 144–155, 1989.
- [47] T. K. Koo, A. F. Mak, L. K. Hung, and J. P. Dewald, "Joint position dependence of weakness during maximum isometric voluntary contractions in subjects with hemiparesis," *Arch. Phys. Med. Rehabil.*, vol. 84, pp. 1380–1386, 2003.
- [48] N. Hogan, H. I. Krebs, B. Rohrer, J. J. Palazzolo, L. Dipietro, S. E. Fasoli, J. Stein, W. R. Frontera, and B. T. Volpe, "Motions or muscles? Some behavioral factors underlying robotic assistance of motor recovery," *J. Rehabil. Res. Develop.*, vol. 43, no. 5, pp. 605–618, 2006.
- [49] J. W. Krakauer, "Motor learning: Its relevance to stroke recovery and neurorehabilitation," *Curr. Opin. Neurol.*, vol. 19, pp. 84–90, 2006.



Rong Song received the B.S. degree in electrical engineering from Tsinghua University, Beijing, China, in 1999, the M.S. degree in electronic engineering from Shantou University, Shantou, China, in 2002, and the Ph.D. degree in biomedical engineering from the Hong Kong Polytechnic University, Kowloon, Hong Kong, in 2006.

He is currently Research Scientist in Philips Research Asia Shanghai. His research interests include musculoskeletal modeling, biomedical signal processing, human motion analysis, and robot-assisted

stroke rehabilitation.



Kai-yu Tong received the Ph.D. degree in bioengineering from the University of Strathclyde, Glasgow, U.K., in 1998.

He spent four months as a Research Fellow at Strathclyde University and participated in a joint project with the Spinal Cord Injury Unit, Southern General Hospital, Glasgow, U.K. He joined the Hong Kong Polytechnic University in 1999 and as an Associate Professor in the Department of Health Technology and Informatics in 2008. His research interests include rehabilitation robot, the control

of functional electrical stimulation for upper and lower extremity functions, sensor development, stroke rat model and gait training rehabilitation on persons after stroke.

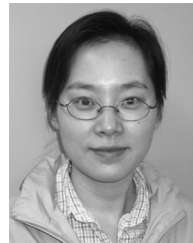

Xiaoling Hu received the Ph.D. degree in biomedical engineering from the Department of Electronic Engineering, the Chinese University of Hong Kong, in 2002.

She joined the Department of Health Technology and Informatics, the Hong Kong Polytechnic University, for postdoctoral training. She is currently an Instructor in the Department of Health Technology and Informatics with research interests in the neuromuscular modeling, bio-signal processing, and design of stroke rehabilitation programs.

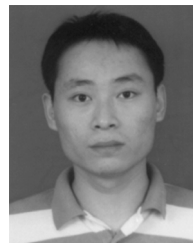

Le Li received the B.E. degree and M.E. degree in biomedical engineering, in 2000 and 2003, respectively, from Xi'an JiaoTong University, Xi'an, China, and Ph.D. degree in the Department of Health Technology and Informatics, The Hong Kong Polytechnic University, in 2007. He is currently Research Associate in The Hong Kong Polytechnic University.

His research interests include neuromusculoskeletal modeling of normal and spastic subjects, biosignal processing, and functional electrical stimulation.