



TECHNISCHE
UNIVERSITÄT
WIEN
Vienna University of Technology

DISSERTATION

COMBINATORICS OF LATTICE PATHS AND
TREE-LIKE STRUCTURES

Ausgeführt zum Zwecke der Erlangung des akademischen
Grades eines Doktors der technischen Wissenschaften unter
der Anleitung von

AO.UNIV.PROF. DIPL.-ING. DR. TECHN. BERNHARD GITTENBERGER
E104, Institut für
Diskrete Mathematik und Geometrie

eingereicht an der Technischen Universität Wien
Fakultät für Mathematik und Geoinformation

von

MICHAEL WALLNER
Matrikelnummer 0825241
Siccardsburggasse 40/120
A-1100 Wien

Wien, am 15. Dezember 2016

Michael Wallner

Bernhard Gittenberger

Manuel Kauers

COMBINATORICS OF LATTICE PATHS AND
TREE-LIKE STRUCTURES

MICHAEL WALLNER

Institute of Discrete Mathematics and Geometry
Vienna University of Technology

December 2016

Michael Wallner: *Combinatorics of lattice paths and tree-like structures*,
December 2016

DECLARATION

I herewith declare that I have completed the present thesis independently, making use only of the specified literature and aids. Sentences or parts of sentences quoted literally are marked as quotations; identification of other references with regard to the statement and scope of the work is quoted. The thesis in this form has not been submitted to an examination body and has not been published. This thesis draws however on previous publications of the author. For a complete list of my relevant scientific articles, I refer to page [xi](#).

Vienna, December 2016

Michael Wallner

ABSTRACT

This thesis is concerned with the enumerative and asymptotic analysis of directed lattice paths and tree-like structures. We introduce several new models and analyze some of their characterizing parameters, such as the number of returns to zero, or their average height and final altitude.

The key tool in this context is the concept of generating functions. Their algebraic and analytic properties will help us to solve the enumeration problems. The methods and many other helpful theorems will be presented in the first part. Due to these methods this thesis belongs to the field of analytic combinatorics.

The second part is dedicated to the study of directed lattice paths. Its first chapter treats the half-normal distribution, and presents a scheme for generating functions leading to such a distribution. We also state applications of this result in the theory of lattice paths. The next chapter continues the work of Cyril Banderier and Philippe Flajolet, and extends their work to the case when a boundary reflecting or absorbing condition is added to the classical models. The subsequent chapter then deals with a different family of paths: lattice paths below a line of rational slope. This work deals with the delicate problem of deriving asymptotic results for generating functions with a periodic support. It also answers an open problem by Donald E. Knuth on the asymptotics of such paths. The final chapter of this part deals with another model: lattice paths with catastrophes, which are jumps from any altitude to the x -axis.

The third part treats the analysis of trees and tree-like structures. In the initial chapter we treat Pólya trees, which are unlabeled rooted trees. We present a new interpretation as Galton-Watson trees with many small forests. In the subsequent chapter we solve the counting problem of compacted trees of bounded right-height. Most trees contain redundant information in form of repeated occurrences of the same subtree. These trees can be compacted by representing each occurrence only once. The positions of the removed subtrees will be remembered by pointers which point to the common subtree. Such structures are known as directed acyclic graphs.

The fourth and final part treats applications of analytic combinatorics to number theory. We study the exact divisibility of binomial coefficients by powers of primes by means of generating functions and singularity analysis.

Some of the results presented in this thesis have already been published in scientific articles by the present author. For a complete list of the papers this thesis is based on, we refer to page [xi](#).

ZUSAMMENFASSUNG

Die vorliegende Dissertation beschäftigt sich mit der analytischen und enumerativen Analyse von gerichteten Gitterwegen und baumartigen Strukturen. Es werden verschiedene, neue Modelle vorgestellt und einige ihrer charakterisierenden Parameter, wie unter anderem die Anzahl der Berührungen der x -Achse, oder ihre durchschnittliche und finale Höhe, untersucht.

Das wichtigste Werkzeug in diesem Kontext sind erzeugende Funktionen. Die vorliegenden Ergebnisse beruhen zum Großteil auf ihren algebraischen und analytischen Eigenschaften, wie ihrer Singularitätsstruktur. Aus diesem Grund ist die vorliegende Arbeit dem Feld der analytischen Kombinatorik zuzuordnen. Eine Einführung in dieses Gebiet wird im ersten Teil dieser Arbeit gegeben.

Der zweite Teil behandelt das Thema der gerichteten Gitterwege. Sein erstes Kapitel ist der Halbnormalverteilung gewidmet. Es wird eine neue Methode zur Charakterisierung von bivariaten erzeugenden Funktionen, in denen ein Parameter markiert wurde, der dieser Grenzverteilung gehorcht, präsentiert. Am Ende werden natürliche Vorkommen dieser Situation vorgestellt. Das folgende Kapitel löst ein offenes Problem von Donald E. Knuth über die Asymptotik von Wegen unter einer Geraden mit rationaler Steigung. Die Lösung benötigt die Behandlung von periodischen Trägern von erzeugenden Funktionen, welche zu periodischen Singularitätsstrukturen führen. Das anschließende Kapitel präsentiert aufbauend auf der Arbeit von Cyril Banderier und Philippe Flajolet ein neues Modell: das "reflection-absorption model". Dieses erlaubt die Modellierung einer reflektierenden oder absorbierenden Randbedingung. Das letzte Kapitel dieses Teils behandelt ein weiteres neues Modell für Gitterwege, in dem "Katastrophen" eingeführt werden. Dies sind Sprünge von beliebiger Höhe zur x -Achse.

Der dritte Teil handelt von Bäumen und baumartigen Strukturen. Zunächst wird eine neue Interpretation von Pólya Bäumen (unmarkierten Wurzelbäumen) vorgestellt, welche diese als Galton-Watson Bäume charakterisiert, an die viele kleine Wälder angehängt werden. Im darauffolgenden Kapitel wird die Kompaktifizierung von binären Bäumen behandelt. Dies führt zu baumartigen Strukturen, den sogenannten "directed acyclic graphs". Ein kompaktifizierter Baum ist ein Baum in dem jeder Teilbaum eindeutig ist und mehrfach auftretende Teilbäume durch Zeiger ersetzt wurden. Durch die Modellierung solcher Objekte mittels exponentiell erzeugender Funktionen wird das asymptotische Abzählproblem für kompaktifizierte Bäume mit beschränkter rechtsseitiger Höhe gelöst.

Im vierten und letzten Teil wird ein neuer Themenschwerpunkt behandelt: Die Anwendung der analytischen Kombinatorik in der Zahlentheorie. Hier wird die exakte Teilbarkeit von Binomialkoeffizienten durch Potenzen von Primzahlen untersucht.

Die in dieser Dissertation vorgestellten Resultate sind zum Teil schon in wissenschaftlichen Artikeln des Autors publiziert worden. Eine Auflistung der dieser Dissertation zu Grunde liegenden Arbeiten findet sich auf Seite [xi](#).

PUBLICATIONS

This thesis is based on the following publications and preprints:

- [26] Cyril Banderier and Michael Wallner. Some reflections on directed lattice paths. In *Proceedings of the 25th International Conference on Probabilistic, Combinatorial and Asymptotic Methods for the Analysis of Algorithms*, pages 25–36, 2014.
- [27] Cyril Banderier and Michael Wallner. Lattice paths of slope $2/5$. In *2015 Proceedings of the Twelfth Workshop on Analytic Algorithmics and Combinatorics (ANALCO)*, pages 105–113. SIAM, Philadelphia, PA, 2015.
- [28] Cyril Banderier and Michael Wallner. The kernel method for lattice paths below a line of rational slope. *Developments in Mathematics Series*, 2016. To appear.
- [29] Cyril Banderier and Michael Wallner. Lattice paths with catastrophes. In *Proceedings of the 10th edition of Génération Aléatoire de Structures COMbinatoires (GASCom 2016)*. Elsevier, 2016. To appear.
- [30] Cyril Banderier and Michael Wallner. The reflection-absorption model for directed lattice paths *Proceedings of the Vienna Young Scientists Symposium (VSS)*, pages 98–99, 2016.
- [96] Bernhard Gittenberger, Antoine Genitrini, Manuel Kauers and Michael Wallner. Compacted binary trees. *Manuscript*, 2017. In preparation.
- [97] Bernhard Gittenberger, Emma Yu Jin and Michael Wallner. A note on the scaling limits of random Pólya trees. In *2017 Proceedings of the Fourteenth Workshop on Analytic Algorithmics and Combinatorics (ANALCO)*, 2017. To appear.
- [172] Lukas Spiegelhofer and Michael Wallner. Divisibility of binomial coefficients by powers of primes. *arXiv preprint*, arXiv:1604.07089, 2016. <http://arxiv.org/abs/1604.07089>. Submitted.
- [181] Michael Wallner. A half-normal distribution scheme for generating functions. *arXiv preprint*, arXiv:1610.00541, 2016. <http://arxiv.org/abs/1610.00541>. Submitted.
- [182] Michael Wallner. A half-normal distribution scheme for generating functions and the unexpected behavior of Motzkin paths. In *Proceedings of the 27th International Conference on Probabilistic, Combinatorial and Asymptotic Methods for the Analysis of Algorithms*, pages 341–352, 2016.

ACKNOWLEDGMENTS

First of all I want to thank my supervisor, Bernhard Gittenberger. I would like to thank him for introducing me to the fascinating world of discrete mathematics and combinatorics. His passion for this field inspired me and I soon adapted it as my driving force too. I am very grateful for all the opportunities he offered me to spend time abroad with other researchers to deepen my understanding, and to attend international conferences to present my results.

Another person I cannot thank enough is Cyril Banderier. He continuously encouraged me to explore new fields of mathematics and he never got tired of explaining when I was lacking the knowledge. Despite the distance we always kept close contact and he was always willing to answer any of my questions. I thank him very much for inviting me several times not only to Paris, but also for hosting me at his house in the Normandy. We spent nights working, discussing, exploring, and playing. Some of these were for sure the most fruitful ones of my studies.

I would also like to thank all the other great researchers whom I met and interacted with during my studies. I thank them for welcoming me so warmly into their world and making me feel part of the Analysis of Algorithms and Analytic Combinatorics community. In particular, my thanks go to Olivier Bodini, Mireille Bousquet-Mélou, Michael Drmota, Danièle Gardy, Antoine Genitrini, Hsien-Kuei Hwang, Manuel Kauers, Christian Krattenthaler, Markus Kuba, Cécile Mailler, Alois Panholzer, Kilian Raschel, Michèle Soria, Stephan Wagner and Mark Daniel Ward. To Bernhard Gittenberger, Manuel Kauers and Kilian Raschel I also owe my thanks for accepting to review my thesis.

During my daily work in Vienna, it were my colleagues as well as my (current and former) roommates who made my days as a PhD student very enjoyable. These are in particular: Andrei Asinowski, Gwendal Collet, Danièle Gardy, Zbigniew Gołębiewski, Emma Yu Jin, Marie-Louise Lackner, Benoît Loricant, Clemens Müllner, Valerie Roitner, Lukas Spiegelhofer and Guan-Ru Yu. My special thanks also go to our (current and former) secretaries who always had a solution to any sort of problem and were always caring for the warm and welcoming atmosphere at our department. These are in particular: Barbara Dolezal-Rainer, Elisabeth Hofmann and Sonja Rees.

My greatest support during the last years was and is my fiancée Birgit Ondra. I cannot say thank you often enough for all that she has done for me. Starting from always encouraging me to pursue my PhD, to proofreading all (!) my papers, and to motivating me to

continue when some ideas did not work as expected. I thank her for her patience when my thoughts were lost in a different world.

All this would not have been possible without the constant support of my family. I want to thank my parents Margarete and Hans Wallner for their moral support and their generosity during the last years. They always accepted my decisions and encouraged me to pursue my goals. I also want to thank my sister Eva-Maria Wallner and my brother Christoph Wallner. Their support was always very important for me and their big interest in my projects motivated me to go even further. My thanks also go to my “new” family, Brigitte and Martin Ondra. Thank you very much for including me in your life and always making me feel welcome.

I would also like to say thank you to all my friends for their genuine interest and moral support during the last years. In particular I would like to say thank you to Harald Bauer, for being my closest friend for now nearly two centuries. I am also very much indebted to Birgit Ondra and Clemens Tomsic for our fantastic time together as students. Especially, I would also like to thank both of you for proof-reading my thesis so carefully. And I want to mention Daniel Fischl, Clemens Janisch and Daniel Karacsonyi, for being very close friends since school and for always staying in contact. Finally, I also want to say thank you to all the kind people I met on my way and whom I did not mention here personally.

Last but not least, my thanks go to the Austrian Science Fund FWF that supported my research throughout the duration of my thesis via the project SFB F50-03 “Combinatorics of Tree-Like Structures and Enriched Trees”.

CONTENTS

I	INTRODUCTION	1
1	AN INVITATION TO ANALYTIC COMBINATORICS AND LATTICE PATH COUNTING	3
1.1	What is a lattice path?	6
1.2	Analytic combinatorics	9
1.3	Łukasiewicz paths	26
1.4	Marking in combinatorial constructions	34
1.5	Basic parameters of Dyck paths	35
1.6	Properties of general directed lattice paths	38
1.7	Introduction to the combinatorics of trees	42
2	METHODS	49
2.1	Probability distributions	49
2.2	Limit laws	51
2.3	Schemes for generating functions	53
2.4	Symmetric polynomials	61
2.5	Tools from Analytic Combinatorics	63
II	LATTICE PATHS	67
3	A HALF-NORMAL DISTRIBUTION SCHEME AND APPLICATIONS TO LATTICE PATHS	69
3.1	The half-normal theorem	70
3.2	Applications to lattice path counting	71
3.3	Proof of Theorem 2.3.9	84
3.4	Conclusion	90
4	THE REFLECTION-ABSORPTION MODEL FOR DIRECTED LATTICE PATHS	91
4.1	The reflection-absorption model	92
4.2	Łukasiewicz walks and excursions	106
4.3	Bridges	112
4.4	Meanders	120
4.5	Moments of the final altitude of meanders	133
4.6	Proofs	139
5	LATTICE PATHS BELOW A LINE OF RATIONAL SLOPE	167
5.1	Trees, fractional trees, imaginary trees	170
5.2	Knuth's AofA problem #4	174
5.3	A bijection for lattice paths below a rational slope	175
5.4	Lattice paths of slope $2/5$	176
5.5	Asymptotics	179
5.6	Links with Nakamigawa/Tokushige	186
5.7	Duchon's club and other slopes	190
5.8	Conclusion	196

6	LATTICE PATHS WITH CATASTROPHES	199
6.1	Generating functions	201
6.2	Bijection for Dyck paths with catastrophes	203
6.3	Asymptotics and limit laws	205
6.4	Uniform random generation	217
6.5	Conclusion	218
	III TREES AND TREE-LIKE STRUCTURES	219
7	A NOTE ON THE SCALING LIMITS OF RANDOM PÓLYA TREES	221
7.1	Decomposing Pólya trees	221
7.2	Main results	223
7.3	The maximal size of a D -forest	226
7.4	D -forests and C -trees	228
7.5	Conclusion and perspectives	233
8	COMPACTED BINARY TREES	235
8.1	Creating a compacted tree	236
8.2	A recurrence relation	240
8.3	Operations on trees	243
8.4	Relaxed binary trees	246
8.5	Compacted binary trees	267
8.6	Connections with Chebyshev polynomials	278
8.7	Conclusion	282
	IV APPLICATIONS TO NUMBER THEORY	285
9	DIVISIBILITY OF BINOMIAL COEFFICIENTS BY POWERS OF PRIMES	287
9.1	A recurrence for the values $\vartheta_p(j, n)$	291
9.2	The polynomials P_j for $j > 1$	292
9.3	Computing the coefficients of P_j	294
9.4	Asymptotic behavior of the coefficients	300
9.5	A simplified recurrence for $\vartheta_p(j, n)$	304
9.6	Divisibility in columns of Pascal's triangle	307
9.7	Proofs	308
	V APPENDIX	319
	NOTATION	321
	COEFFICIENT ASYMPTOTICS OF STANDARD FUNCTIONS	323
	BIBLIOGRAPHY	325
	CURRICULUM VITÆ	341

Part I

INTRODUCTION

This part is split into two chapters. Chapter [1](#) is designed as a crash course in analytic combinatorics and lattice path counting. The basic definitions and concepts such as generating functions, the symbolic method, and the method of singularity analysis are introduced. Then these concepts are applied to the most simple yet interesting class of lattice paths: Łukasiewicz paths. At the end the general results for directed lattice paths are stated and a short introduction into the combinatorics of trees is given. In Chapter [2](#) deeper concepts such as later encountered probability distributions, schemes for generating functions and symmetric polynomials are introduced.

AN INVITATION TO ANALYTIC COMBINATORICS AND LATTICE PATH COUNTING

The aim of this chapter is to give an introduction to lattice path combinatorics. All necessary derivations are made explicit and connections to other parts in the literature are added. This chapter is based on a mini course with the same title “An invitation to analytic combinatorics and lattice path counting” held at the ALEA in Europe Young Researchers’ Workshop in Bath, UK, together with Marie-Louise Lackner.

For a more detailed introduction, we refer to the master’s thesis of the author [180]. It gives an introduction into three well studied families of lattice paths (directed paths, walks confined to the quarter plane, and self avoiding walks) as well as recent developments in the field.

The theory of lattice paths is ubiquitous in the technical sciences. They appear in physics as models in statistical mechanics [116, 118], in computer science where they are used as models in the analysis of algorithms [11, 126], as well as in chemistry where they are the up-to-date model of certain polymers [51, 75, 88, 117]. This broad applicability, and their interesting properties underline their importance (not only) in combinatorics.

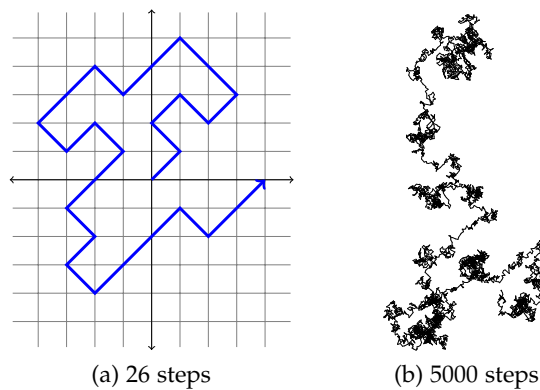

Figure 1: Two random walks in the Euclidean plane, see [180, Figure 1].

As already stated in [180], another, more fundamental, fascination for this topic is founded on the fact that despite the easily understood construction of lattice paths, many questions remain open. This statement is supported by Figure 1. In the small scale, lattice paths look like mathematical doodles, but when taking a few steps further away, they exhibit a completely different behavior. A fractal structure becomes visible, giving a glimpse of the difficulties encountered in lattice path combinatorics.

A historical introduction: the ballot problem

The so-called ballot problem is formulated as follows:

We suppose that two candidates have been submitted to a vote in which the number of voters is μ . Candidate A obtains n votes and is elected; candidate B obtains $m = \mu - n$ votes. We ask for the probability that during the counting of the votes, the number of votes for A is at all times greater than the number of votes for B.

In 1887, Joseph Louis François Bertrand published an answer to this question in the *Comptes Rendus de l'Academie des Sciences* [39]: The probability is simply $(2n - \mu)/\mu = (n - m)/(n + m)$. This result is now known as the first ballot theorem.

His “proof” was a rather non-rigorous argument based on a recurrence relation that is fulfilled by the counting sequences of votes having the desired property. The first formal proof was given by Désiré André in [9].

In this context, it is very helpful to represent sequences of votes with the help of paths in the Euclidean plane. Therefore, the ballot problem can be seen as the birth hour of lattice path theory. We start at the origin $(0,0)$ and move one step for every vote: If the vote is for candidate A we move one unit to the right and one unit up, if the vote is for candidate B we move one unit to the right and one unit down. If there are n votes for A and $m = \mu - n$ votes for B this means that we end in the point $(\mu, 2n - \mu)$ (which lies in the first quadrant since A wins the election). Then, the property that the number of votes for A is at all times greater than the number of votes for B is simply translated into the fact that the lattice path may never touch the x -axis (except at the beginning).

In Figure 2, the black lattice path corresponds to the sequence of votes AABAABABBAAB and the red one to the sequence ABBAABAAABBA. In both cases A wins the election but only the black path has the property that A is always ahead of B.

For more details on the history of the ballot problem and also on lattice paths in general we refer to Humphreys’ survey [111].

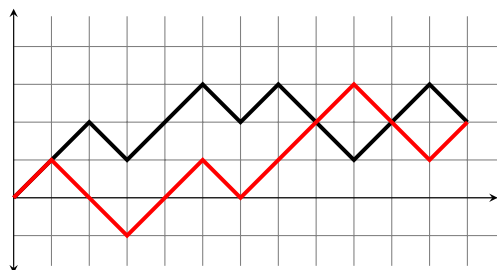

Figure 2: Lattice paths used to represent sequences of votes.

Variants and special cases

In the original problem one has to find the probability that candidate A is always strictly ahead of B in the vote count. If one is interested in sequences of votes where B is never ahead of A, this means that the corresponding lattice paths may never go below the x -axis but are allowed to touch it. In this case, the probability is $(n - m + 1)/(n + 1)$.

If we consider the special case that ties are allowed and that A and B both obtain the exact same number of votes we obtain an important class of lattice paths called *Dyck paths*¹. The five Dyck paths of length six are represented in Figure 3. These paths will occur at various places throughout this thesis.

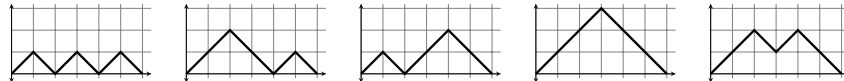

Figure 3: The five Dyck paths consisting of six steps.

One can also consider variants of the ballot problem where the two options have different weights. For instance, consider the following scenario known as *Duchon's club model* [73]: A club opens in the evening and closes in the morning. People arrive by pairs and leave in threesomes. What is the possible number of scenarios from dusk to dawn as seen from the club's entry? This problem translates into lattice paths starting at the origin and never going below the x -axis with $(1, 2)$ and $(1, -3)$ as possible steps.

Another related problem is the so-called *gambler's ruin problem*: Two players, Alice and Bob, play a coin tossing game. Alice starts the game with a pennies and Bob with b pennies; the game ends as soon as one of the players has gone broke. The rules are as follows: The players take turns tossing a coin and each player has a 50% chance of winning with each flip of the coin. At each round, the winner gets one penny from the loser. Such a game can be described as a random lattice path starting at $(0, a)$, never going above the horizontal line $y = a + b$ and never going below the x -axis. At each stage, the probability of a step up and of a step down is the same. Now the question is, when does the path reach the line $y = a + b$ (Alice wins) or the x -axis (Bob wins) for the first time. The answer is simple: The probability that Alice loses is $b/(a + b)$ and the probability that Bob loses is $a/(a + b)$. One can of course also consider variants of this game where player one wins each toss with probability p , and player two wins with probability $q = 1 - p$, where $p \neq q$. In this case a step up occurs with probability p and a step down with probability q .

¹ named after Walther von Dyck, 6.12.1856–5.11.1934

Other objects counted by the same numbers as Dyck paths

Dyck paths are probably the most famous example of lattice paths and will occur at several occasions throughout this thesis. As we will see later on, Dyck paths are counted by the Catalan numbers. In his newly published book *Catalan numbers* [173], Richard Stanley presents 214 different kinds of objects counted by them. Here is a short list of some famous objects counted by the Catalan numbers:

- Expressions containing n pairs of parentheses which are correctly matched.
- Different ways a convex polygon with $n + 2$ sides can be cut into triangles by connecting vertices with straight lines.
- Rooted binary trees with n internal nodes ($n + 1$ leaves).
- Permutations of the set $\{1, 2, \dots, n\}$ that avoid the pattern 321. A permutation π avoids the pattern 321 if we cannot find a subsequence xyz of π such that $x > y > z$.

1.1 WHAT IS A LATTICE PATH?

One central topic of investigation of this thesis are lattice paths. As the name suggests, they depend on a lattice, which can be described informally as a regular arrangement of points in the Euclidean space \mathbb{R}^n . Lattice paths can be used to encode various combinatorial objects such as trees, maps, permutations, lattice polygons, Young tableaux, queues, etc.

We start with a general and for our purpose suitable definition of the term *lattice*. Note that there are various ways of defining this term.

Definition 1.1.1. A lattice $\Lambda = (V, E)$ is a mathematical model of a discrete space. It consists of a set $V \subset \mathbb{R}^d$ of vertices, and a set $E \subset \{\{v_1, v_2\} : v_1, v_2 \in V\}$ of edges. If two vertices are connected via an edge, we call them nearest neighbors.

A lattice is called periodic, if there exist vectors v_1, \dots, v_k , such that the lattice is mapped to itself under any arbitrary translation $\sum_j \alpha_j v_j$ where $\alpha_j \in \mathbb{Z}$ for $j = 1, \dots, k$.

The importance of periodic lattices lies in the fact that they have a form of translation invariance.

Some examples of periodic lattices are shown in Figure 4. The expression “lattice” actually stems from physics. In mathematics and computer science lattices are also called *graphs* or *networks*.

On a lattice we want to look at walks that connect the vertices of the lattice. The basic component of a walk is a *step*, which essentially is nothing else than an edge.

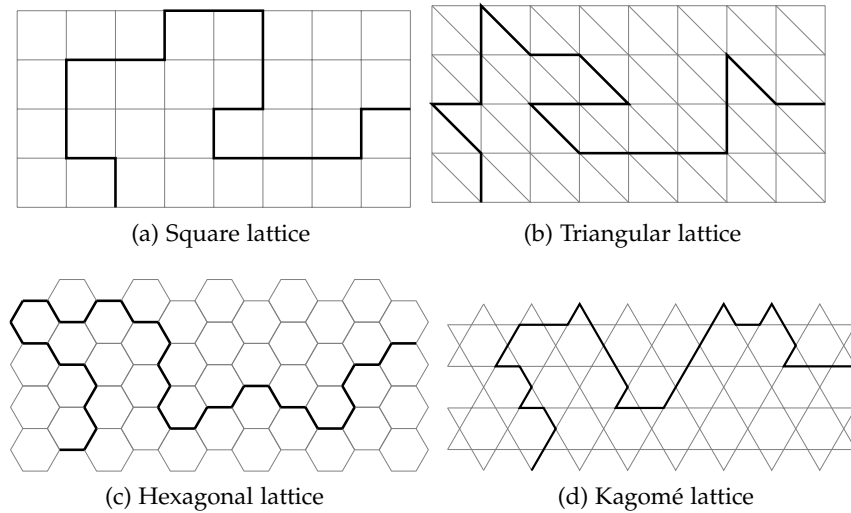

Figure 4: Examples of lattices.

Definition 1.1.2. Let $\Lambda = (V, E)$. An n -step lattice path or lattice walk or walk from $s \in V$ to $x \in V$ is a sequence $\omega = (\omega_0, \omega_1, \dots, \omega_n)$ of elements in V , such that

1. $\omega_0 = s, \omega_n = x$,
2. $(\omega_i, \omega_{i+1}) \in E$.

The length $|\omega|$ of a lattice path is the number n of steps (edges) in the sequence ω .

During this thesis we are going to work on the *Euclidean lattice*, which consists of the vertices \mathbb{Z}^d . On this lattice an alternative definition of the edges via the so-called step set can be used. The step set \mathcal{S} is a subset of \mathbb{Z}^d and defines how one can move from one vertex to another.

Consider the following example of a popular 2-dimensional model.

Example 1.1.3. If the step set \mathcal{S} is a subset of $\{-1, 0, 1\}^2 \setminus \{(0, 0)\}$, then we say \mathcal{S} is a set of *small steps*.

In order to simplify notation, it is sometimes more convenient to use a more intuitive terminology by representing a step set by the corresponding points on a compass or by a picture. Figure 5 shows the full set of small steps. In this special case moving from $(1, 0)$ counterclockwise corresponds to **E, NE, N, NW, W, SW, S** and **SE**.



Figure 5: The full set of small steps.

We can now give an alternative definition of lattice paths on the Euclidean lattice:

Definition 1.1.4. An n -step lattice path or lattice walk or walk from $s \in \mathbb{Z}^d$ to $x \in \mathbb{Z}^d$ relative to \mathcal{S} is a sequence $\omega = (\omega_0, \omega_1, \dots, \omega_n)$ of elements in \mathbb{Z}^d , such that

1. $\omega_0 = s, \omega_n = x$,
2. $\omega_{i+1} - \omega_i \in \mathcal{S}$.

The length $|\omega|$ of a lattice path is the number n of steps in the sequence ω .

Comparing Definitions 1.1.2 and 1.1.4 we see that in the second case $V = \mathbb{Z}^d$ and the set of possible edges E is implicitly defined by the set of allowed steps. The edge $(x, y) \in E$ exists if and only if $(y - x) \in \mathcal{S}$. Note that the step set is defined globally for all vertices, i.e., the lattice has the same structure at every vertex. Thus, the lattice paths on the lattices (a) and (b) in Figure 4 can be defined with the help of a step set: The square lattice corresponds to the step set $\mathcal{S} = \{(1, 0), (0, 1), (-1, 0), (0, -1)\}$ and the triangular lattice to the step set $\mathcal{S} = \{(1, 0), (0, 1), (-1, 1), (-1, 0), (0, -1), (1, -1)\}$. However, lattice paths on the lattices (c) and (d) cannot be defined with the help of a step set as can be seen easily. The advantage of the second definition is its compact form, which is why we are going to choose this one from now on.

Remark 1. In the remainder of this thesis, we are going to work in the Euclidean plane only. Moreover, we will restrict Definition 1.1.4 and impose that lattice paths always start at the origin $s = (0, 0)$. But this fact will not represent a restriction to our discussion, as we are going to consider *homogeneous* lattices. These are lattices for which the number of n -step walks starting at s is independent of the starting point s for all values of n . This is a general property of periodic lattices.

For more details on the basic properties of lattices we refer to [110].

In the Euclidean plane, we can also describe a lattice path by a polygonal line. An example is shown in Figure 6, where an unrestricted walk on the lattice \mathbb{Z}^2 and the set of small steps from which it was constructed, is shown. In this context unrestricted means that there are no boundaries on the domain (lattice) that we allow self-intersections, and that the walk ends at an arbitrary point.

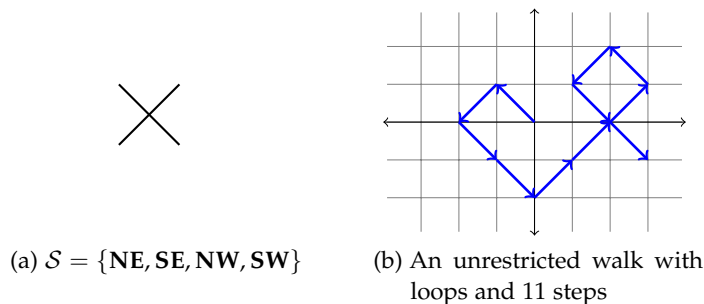

Figure 6: Unrestricted path with loops in \mathbb{Z}^2 .

Obviously, another equivalent way of representing a walk with a fixed start point is by providing the sequence of performed steps. For example, the walk in Figure 6b is given by the sequence

(NW, SW, SE, SE, NE, NE, NE, NW, SW, SE, SE)

or

(↖, ↙, ↘, ↘, ↗, ↗, ↗, ↖, ↙, ↘, ↘).

In many situations it is useful to associate weights to single steps:

Definition 1.1.5 (Weights). For a given step set \mathcal{S} , we define the respective system of weights as $\{p_s : s \in \mathcal{S}\}$ where $p_s > 0$ is the weight associated to step $s \in \mathcal{S}$. The weight of a path is defined as the product of the weights of its individual steps.

Some useful choices are:

- $p_s = 1$: Combinatorial paths in the standard sense;
- $p_s \in \mathbb{N}$: Paths with colored steps, i.e. $p_s = 2$ means that the associated step has two possible colors;
- $\sum_s p_s = 1$: Probabilistic model of paths, i.e. step s is chosen with probability p_s .

Example 1.1.6. The gambler's ruin problem where Alice starts with a pennies and Bob with b pennies and where Alice has the probability p of winning a round and Bob has the probability $q = 1 - p$ can be modelled with the help of weighted lattice paths. If the lattice path represents the number of pennies that Alice has, it starts at $(0, a)$ and the possible steps are $s_1 = (1, 1)$ with $p_{s_1} = p$ and $s_2 = (1, -1)$ with $p_{s_2} = q$.

1.2 ANALYTIC COMBINATORICS

“Combinatorics, the branch of mathematics concerned with the theory of enumeration, or combinations and permutations, in order to solve problems about the possibility of constructing arrangements of objects which satisfy specified conditions.”²

The focus of this thesis with respect to the preceding definition lies on the enumeration of objects which are mostly described by recursions and boundary conditions, namely lattice paths. A standard tool in this context are generating functions which were introduced as formal power series whose coefficients give the sizes of a sought family of objects with respect to a parameter encoded in the exponent. A very colorful description from Wilf³ [187] says

² CollinsDictionary.com, <http://www.collinsdictionary.com/dictionary/english/combinatorics>, accessed 26/10/2016.

³ Herbert Wilf, 13.6.1931-7.1.2012

“A generating function is a clothesline on which we hang up a sequence of numbers for display.”⁴

It describes quite vividly the idea of generating functions. This tool has led to many new insights in the field of combinatorics, by introducing new possible solution strategies. Their importance can be seen in the vast amount of available literature, like Stanley’s⁵ books *Enumerative combinatorics, I and II* [174, 175] which, among other things, introduce a classification of generating functions, which has proved to be useful and applicable for lattice path combinatorics as well.

Furthermore, generating functions serve as a link for interdisciplinary applications of techniques from different branches of mathematics. One very important field, which found entrance to combinatorics, is complex analysis. This revolutionized the field and led to the new branch of *Analytic Combinatorics*. The fathers of this development are Flajolet⁶ and Sedgewick⁷. In their highly recommendable book *Analytic Combinatorics* [85] they summarize hundreds of papers of this development and unify the notation and presentation. The key idea is the interpretation of formerly only algebraically investigated formal power series as complex analytic functions on their radii of convergence. This allows the extraction of the asymptotic behavior and much more.

The structure of the subsequent chapter was inspired by [121, Chapter 4] and gives an introduction to symbolic methods, using [85, 174, 175, 187].

Formal Power Series

Formal power series are a central object of investigation. For a ring R we denote by $R[z]$ the ring of polynomials in z with coefficients in R .

Definition 1.2.1. *Let R be a ring with unity. The ring of formal power series $R[[z]]$ consists of all formal sums of the form*

$$\sum_{n \geq 0} a_n z^n = a_0 + a_1 z + a_2 z^2 + \dots,$$

with coefficients $a_n \in R$.

The sum of two formal power series $\sum_{n \geq 0} a_n z^n$, $\sum_{n \geq 0} b_n z^n$ is defined by

$$\sum_{n \geq 0} a_n z^n + \sum_{n \geq 0} b_n z^n = \sum_{n \geq 0} (a_n + b_n) z^n$$

and their product by

$$\sum_{n \geq 0} a_n z^n \cdot \sum_{n \geq 0} b_n z^n = \sum_{n \geq 0} \left(\sum_{k=0}^n a_k b_{n-k} \right) z^n.$$

⁴ Wilf, *generatingfunctionology*, p. 1

⁵ Richard Peter Stanley, 23.6.1944-

⁶ Philippe Flajolet, 1.12.1948-22.3.2011

⁷ Robert Sedgewick, 20.12.1946-

Definition 1.2.2. Let $A(z) = \sum_{n \geq 0} a_n z^n$ be a formal power series. We define the linear operator $[z^n]A(z)$ as

$$[z^n]A(z) = a_n,$$

called the coefficient extraction operator.

The coefficient extraction operator satisfies the following identity for all suitable k , i.e. all expressions have to be well-defined:

$$[z^{n-k}]A(z) = [z^n]z^k A(z). \tag{1}$$

Let us recall some important power series expansions:

$$\begin{aligned} \frac{1}{1-x} &= \sum_{n \geq 0} x^n, & e^x &= \sum_{n \geq 0} \frac{1}{n!} x^n, \\ \log(1+x) &= \sum_{n \geq 1} \frac{(-1)^{n+1}}{n} x^n, & (1+x)^\alpha &= \sum_{n \geq 0} \binom{\alpha}{n} x^n, \end{aligned}$$

where $\binom{\alpha}{n} = \alpha(\alpha-1) \cdots (\alpha-n+1)/n!$.

Combinatorial Classes and Ordinary Generating Functions

Following [85, pp. 16] we give a short introduction to the symbolic method. In particular, we emphasize on the topics important for lattice path combinatorics.

Definition 1.2.3. A combinatorial class, or simply a class, is a finite or denumerable set on which a size function is defined, satisfying the following conditions:

1. the size of an element is a non-negative integer;
2. the number of elements of any given size is finite.

If \mathcal{A} is a class, the size of an element $\alpha \in \mathcal{A}$ is denoted by $|\alpha|$, or $|\alpha|_{\mathcal{A}}$ in the few cases where the underlying class is not clear from the context. Using this size function, we decompose \mathcal{A} into disjoint subclasses \mathcal{A}_n , which contain all elements of \mathcal{A} of size n and we denote the cardinality of these subsets by $a_n = \text{card}(\mathcal{A}_n)$.

In accordance with this definition we define the class $\mathcal{W} = \mathcal{W}_{\mathcal{S}, \Lambda}$ to be the set of all walks on a lattice Λ with respect to the step set $\mathcal{S} = \mathcal{S}_\Lambda$. Here, $|\omega|$ is the length of a walk $\omega \in \mathcal{W}$.

Definition 1.2.4. The counting sequence of a combinatorial class \mathcal{A} is defined as the sequence of integers $(a_n)_{n \geq 0}$.

Definition 1.2.5. Two combinatorial classes \mathcal{A} and \mathcal{B} are said to be (combinatorially) isomorphic, which is written $\mathcal{A} \cong \mathcal{B}$, if and only if their counting sequences are identical. This condition is equivalent to the existence of a bijection from \mathcal{A} to \mathcal{B} that preserves size. One also says \mathcal{A} and \mathcal{B} are bijectively equivalent.

Note that such a bijection, despite it needs to exist, is not always easy to find. Also, such bijections do not necessarily have to behave in a nice or natural manner. For example, it is straightforward to give a bijection between Dyck paths and the number of ways to correctly match n pairs of brackets. But it is less obvious to provide such a correspondence between Dyck paths and 321-avoiding permutations, see e.g. [173].

The enumerative information of a class is stored in the formal power series $A(z)$.

Definition 1.2.6. *The ordinary generating function (OGF) of a sequence $(a_n)_{n \geq 0}$ is the formal power series*

$$A(z) = \sum_{n \geq 0} a_n z^n.$$

The OGF of a combinatorial class \mathcal{A} is the generating function for the counting sequence $a_n = \text{card}(\mathcal{A}_n)$, $n \geq 0$. Equivalently, the combinatorial form

$$A(z) = \sum_{\alpha \in \mathcal{A}} z^{|\alpha|},$$

is employed. We say the variable z marks the size in the generating function.

Note that there are two special classes:

Class	Nr. of elements	Weights	OGF
Neutral class \mathcal{E}	1	0	$E(z) = 1$
Atomic class \mathcal{Z}	1	1	$Z(z) = z$

Here is a brief summary of the introduced naming convention:

Class	Subclass of el. of size n	Cardinality of subclass	OGF
\mathcal{A}	\mathcal{A}_n	a_n	$A(z)$

Generating functions are elements of the ring of formal power series $\mathbb{C}[[z]]$, thus they can be manipulated algebraically. Two basic operations are the sum and the Cauchy product.

Firstly, let \mathcal{A} and \mathcal{B} be two disjoint classes. Their union $\mathcal{C} = \mathcal{A} \cup \mathcal{B}$ represents a new class with size defined consistently as

$$|\gamma|_{\mathcal{C}} = \begin{cases} |\gamma|_{\mathcal{A}}, & \text{if } \gamma \in \mathcal{A}, \\ |\gamma|_{\mathcal{B}}, & \text{if } \gamma \in \mathcal{B}. \end{cases}$$

This translates naturally into $c_n = a_n + b_n$ which leads to the following generating function for \mathcal{C} :

$$C(z) = A(z) + B(z) = \sum_{n \geq 0} (a_n + b_n) z^n.$$

Secondly, their Cartesian product $\mathcal{C} = \mathcal{A} \times \mathcal{B} = \{\gamma = (\alpha, \beta) \mid \alpha \in \mathcal{A}, \beta \in \mathcal{B}\}$ represents a new class with size defined consistently as

$$|\gamma|_{\mathcal{C}} = |\alpha|_{\mathcal{A}} + |\beta|_{\mathcal{B}}.$$

In this case we have to consider all possibilities in the manner of a Cauchy product, hence $c_n = \sum_{k=0}^n a_k b_{n-k}$, and we conclude as anticipated

$$C(z) = A(z) \cdot B(z) = \sum_{n \geq 0} \left(\sum_{k=0}^n a_k b_{n-k} \right) z^n.$$

These two constructions are enough to derive many fundamental constructions that build upon the set-theoretic union and product. For instance, we can use sum and product in order to define the sequence class. If \mathcal{B} is a class then the *sequence* class $\text{SEQ}(\mathcal{B})$ is defined as the infinite sum

$$\text{SEQ}(\mathcal{B}) = \mathcal{E} + \mathcal{B} + (\mathcal{B} \times \mathcal{B}) + (\mathcal{B} \times \mathcal{B} \times \mathcal{B}) + \dots \quad (2)$$

Note that this construction makes only sense if \mathcal{B} contains no element of size 0. Otherwise the union would contain an infinite number of elements of size 0. Using the sum and product as introduced before, we obtain the following relation for the generating function $A = \text{SEQ}(\mathcal{B})$:

$$A(z) = \frac{1}{1 - B(z)}.$$

More constructions can be derived with the same ideas, see e.g. [85, Theorem I.1].

The true power resulting from the *symbolic method* is best understood by examples. Let us consider two cases in which we apply the above definitions and operations.

Example 1.2.7 (Unrestricted paths). Consider the class \mathcal{W} of unrestricted lattice paths employing the step set $\mathcal{S} = \{\mathbf{NE}, \mathbf{SE}\}$ as illustrated in Figure 7a. There are many ways to describe the construction of lattice paths. The most natural way is a step-by-step construction, from which one can deduce a recursive definition for the number of sought paths. Let w_n denote the number of paths of length n . Then, $w_{n+1} = w_n \cdot 2$ since there are two ways of extending a path of length n to a path of length $n + 1$: we can either take a step up or a step down. Since $w_0 = 1$, it follows that $w_n = 2^n$.

Alternatively, one can describe the construction of the combinatorial class and translate this into the language of generating functions, which we want to demonstrate here. In this case, the direct approach is much simpler but the combinatorial construction-approach serves as a simple first example and should help to get accustomed to the symbolic method.

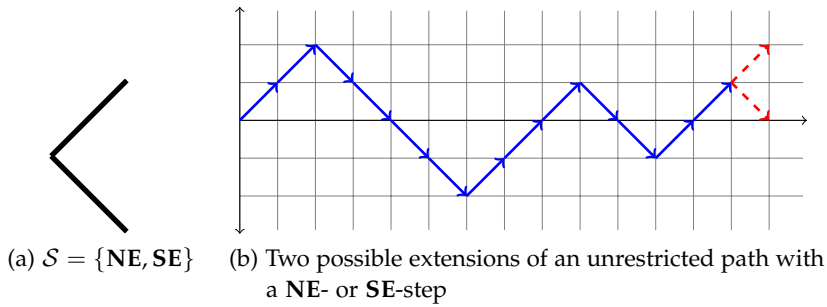

Figure 7: Unrestricted NE-/SE-path.

A member of the class \mathcal{W} is either the empty path or a path of non-zero length n . In the latter case we can construct a path of length $n + 1$ by extending the path by one step out of the step set \mathcal{S} . The resulting path is again a member of \mathcal{W} . This informal description is visualized in Figure 7b and translates into

$$\mathcal{W} = \underbrace{\mathcal{E}}_{\text{empty path}} \cup \underbrace{\mathcal{W} \times \mathcal{Z}_{\text{NE}}}_{\text{append NE-step}} \cup \underbrace{\mathcal{W} \times \mathcal{Z}_{\text{SE}}}_{\text{append SE-step}}.$$

As we do not distinguish between NE- and SE-steps we have $\mathcal{Z}_{\text{NE}} \cong \mathcal{Z}_{\text{SE}} \cong \mathcal{Z}$. Hence, we are able to apply the symbolic method by translating this equation into an equation on the corresponding generating functions:

$$W(z) = 1 + zW(z) + zW(z) = 1 + 2zW(z). \tag{3}$$

This equation can be solved algebraically and we get the solution

$$W(z) = \frac{1}{1 - 2z}. \tag{4}$$

In this case we extract the coefficients easily and get that the number of n -step unrestricted lattice paths with the step set \mathcal{S} starting from the origin is

$$w_n = [z^n]W(z) = [z^n] \frac{1}{1 - 2z} = [z^n] \sum_{k \geq 0} 2^k z^k = 2^n.$$

Note that in this case it was quite easy to solve the functional equation (3). But in most general cases we are not able to deduce such a simple form for the solution and all we get is a relation on the generating functions. One main objective of analytic combinatorics is to develop different techniques how to deal with these cases and how to extract enough information from this equation, in order to decide on certain properties of the solution.

Remark 2. From algebra we know that solutions of algebraic equations are unique up to multiplicity of roots. Recalling the definition of combinatorial isomorphic classes this gives us an easy way to check such

isomorphisms: If the generating functions of two classes satisfy the same functional equation, then the coefficient sequences satisfy the same recursion.

In order to prove isomorphism, all that is left is to check the initial values. This can also be achieved by comparison of the first “few” (depending on the order of the recursion/equation) terms of the sequence. Note that it is important to perform this check. A straightforward example of two classes whose generating functions fulfil the same functional equation are the neutral class \mathcal{E} and the empty class \mathcal{N} , which has no elements at all. Both generating functions satisfy the equation $A(z)^2 = A(z)$, but they are not the same, as $E(z) = 1$ and $N(z) = 0$, respectively.

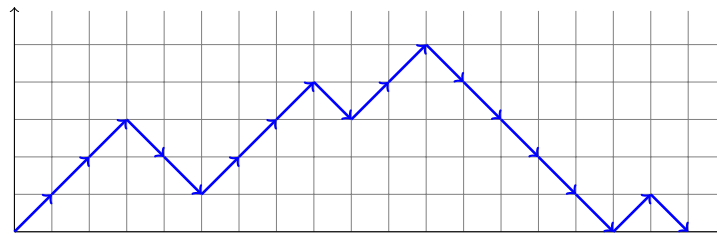

Figure 8: A Dyck path of length 18.

Example 1.2.8 (Dyck paths, [85, pp. 319]). Dyck paths were already discussed as a motivation at the beginning of this chapter. Let us recall their definition: They are paths on the same step set $\mathcal{S} = \{\mathbf{NE}, \mathbf{SE}\}$ but with the restriction that they never leave the first quadrant and end on the x -axis. An example is shown in Figure 8.

As before, we are able to construct a functional equation for the OGF $D(z)$ of Dyck paths using the introduced operations: The technique we will apply is known as *First passage decomposition*. Basically it decomposes an arbitrary path $\omega \in \mathcal{D}$ into two (possibly empty) paths also belonging to \mathcal{D} .

A member of the class \mathcal{D} is either the empty path or a path of non-zero length. If it is of non-zero length, after the initial point of contact with the x -axis at the origin, there will be another point of contact. Denote the first such second point by x_0 . Next, consider the path from the origin to x_0 without the initial \mathbf{NE} - and the final \mathbf{SE} -step. This (possibly empty) sub-path is also a legitimate Dyck path that belongs to \mathcal{D} . (Recall that the empty path is also a member of \mathcal{D} .) After the “first passage”, which ends at x_0 , there will be another path starting at x_0 and ending on the x -axis. This path could be empty as well, but it is, as before, again a Dyck path. The described procedure is depicted in Figure 9.

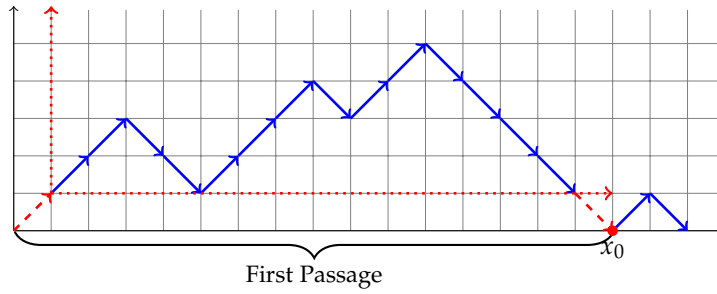

Figure 9: First passage decomposition of Dyck path.

This informal description translates into

$$D = \underbrace{\mathcal{E}}_{\text{empty path}} \cup \underbrace{\mathcal{Z}_{\text{NE}} \times D \times \mathcal{Z}_{\text{SE}} \times D}_{\text{first passage}}.$$

Let d_n be the number of Dyck paths with $2n$ steps (one can e.g. map every up step to a down step and count them as one). With the same reasoning as before the symbolic method gives

$$D(z) = 1 + z(D(z))^2. \tag{5}$$

Here we obtained a quadratic functional equation, which has the two possible solutions

$$D_{\pm}(z) = \frac{1 \pm \sqrt{1 - 4z}}{2z}.$$

Taking a closer look at $D_+(z)$, we see that it possesses a singularity at 0, which corresponds to the constant term of the formal power series, and ought to be 1. Hence, we can dismiss this branch and arrive at the final solution

$$D(z) = \frac{1 - \sqrt{1 - 4z}}{2z}. \tag{6}$$

After using Newton’s expansion theorem for general exponents and some elementary manipulations of binomial coefficients we get

$$d_n = [z^n]D(z) = \frac{1}{n + 1} \binom{2n}{n} = C_n,$$

the n -th Catalan number (OEIS A000108⁸), as the number of n -step Dyck paths.

In the last two examples we have seen that the sought-after OGFs may be the solutions of algebraic equations, compare (3) and (5). But in the case of our first example, the OGF is even a rational function,

⁸ Axxxxxx refers to the corresponding sequence in the On-Line Encyclopedia of Integer Sequences, available electronically at <https://oeis.org>.

see (4). Naturally the question for a general classification of all possible generating functions arises. Stanley introduces a suitable hierarchy in [174, Chapter 6].

Recently, a lot of research was conducted on such classifications for “big” classes of lattice paths, see e.g. for walks in the quarter plane [48, 133]. Especially in computer algebra such a classification is of interest, as there exist efficient algorithms for problems in these specific classes. However, we will not pursue this direction here.

Classification of Ordinary Generating Functions

Throughout this whole chapter let K be a field with characteristic $\text{char } K = 0$, and F be an arbitrary formal power series with coefficients in K , hence an element from the ring $K[[z]]$. The goal of this section is to introduce the three concepts of *rational*, *algebraic* and *D-finite* or *holonomic* functions. As seen before, algebraic functions are a natural generalization of rational functions. Analogously, *D-finite* functions are a natural generalization of algebraic functions. Thus, we get the hierarchy

$$\begin{array}{ccc}
 D\text{-finite/holonomic} & & \\
 \uparrow & & \\
 \text{algebraic} & & (7) \\
 \uparrow & & \\
 \text{rational} & &
 \end{array}$$

Stanley remarks that this hierarchy is by far not exhaustive, as various classes could be added, but these three seem to be the most useful ones for enumerative combinatorics.

Definition 1.2.9. *A formal power series $F(z) \in K[[z]]$ is rational if there exist polynomials $P(z), Q(z) \in K[z]$, with $Q(z) \neq 0$, such that*

$$F(z) = \frac{P(z)}{Q(z)}.$$

As mentioned before we have already seen a rational OGF in (4). Note that rationality corresponds to a linear recurrence relation. This follows directly from rearranging the above definition to $F(z)Q(z) = P(z)$ in the language of OGFs. The concept of algebraic functions is a natural generalization to higher degrees.

Definition 1.2.10. *A formal power series $F(z) \in K[[z]]$ is algebraic if there exist polynomials $P_0(z), P_1(z), \dots, P_d(z) \in K[z]$, not all 0, such that*

$$P_d(z)F(z)^d + P_{d-1}(z)F(z)^{d-1} + \dots + P_1(z)F(z) + P_0(z) = 0.$$

The smallest positive integer d for which this equation holds is called the degree of F .

Example 1.2.11. As seen in Example 1.2.8 the OGF $D(z) = \frac{1-\sqrt{1-4z}}{2z}$ of Dyck paths satisfies

$$zD(z)^2 - D(z) + 1 = 0.$$

Thus, D is algebraic and of degree 2.

But there exists a larger class of functions, which encloses all algebraic functions: the D -finite (short for *differentiably finite*) or holonomic functions.

Definition 1.2.12. A formal power series $F(z) \in K[[z]]$ is D -finite or holonomic, if there exist polynomials $P_0(z), P_1(z), \dots, P_d(z) \in K[z]$, with the property $P_d(z) \neq 0$, such that

$$P_d(z)F^{(d)} + P_{d-1}(z)F^{(d-1)} + \dots + P_1(z)F' + P_0(z)F = 0, \quad (8)$$

where $F^{(j)} = d^j F / dz^j$ and $d \in \mathbb{N}$ is the order of the differential equation.

Remark 3. The historical source of holonomic functions is found in the theory of linear recursions. A sequence $(f_n)_{n \in \mathbb{N}}$ of complex numbers is *holonomic* or *P-recursive* (short for *polynomially recursive*) if it satisfies a homogeneous linear recurrence relation of finite degree with polynomial coefficients, i.e.

$$p_d(n)f_{n+d} + p_{d-1}(n)f_{n+d-1} + \dots + p_0(n)f_n = 0, \quad n \geq 0,$$

for some polynomials $p_i(x) \in \mathbb{C}[x]$. Let $F(z) = \sum_{n \geq 0} f_n z^n$ be the formal power series formed by the sequence $(f_n)_{n \in \mathbb{N}}$. As anticipated by the naming convention, a sequence is holonomic if and only if its generating function is holonomic, see [174, Proposition 6.4.3].

Proposition 1.2.13 ([174, Proposition 6.4.1]). Let $U \in K[[z]]$. The following three conditions are equivalent:

- (i) U is holonomic.
- (ii) There exist polynomials $Q_0(z), \dots, Q_m(z), Q(z) \in K[z]$, with the condition $Q_m(z) \neq 0$, such that

$$Q_m(z)U^{(m)} + \dots + Q_1(z)U' + Q_0(z)U = Q(z). \quad (9)$$

- (iii) The vector space over the field $K(z)$ spanned by U and all its derivatives U', U'', \dots is finite-dimensional, i.e.

$$\dim_{K(z)} [K(z)U + K(z)U' + K(z)U'' + \dots] < \infty.$$

Proof. (i) \Rightarrow (ii): Trivial.

(ii) \Rightarrow (iii): Suppose (9) holds and t is the degree of $Q(z)$. After differentiating (9) $t + 1$ times we get an equation in the form of (8), with $d = m + t + 1$ and $P_d(z) = Q_m(z) \neq 0$. Solving for $U^{(d)}$ yields

$$U^{(d)} = h_0(z)U + h_1(z)U' + \dots + h_{d-1}(z)U^{(d-1)}, \quad (10)$$

with polynomials $h_0(z), \dots, h_{d-1} \in K[z] \subset K(z)$. Differentiating this expression with respect to z we get

$$\begin{aligned} U^{(d+1)} &= \tilde{h}_0(z)U + \tilde{h}_1(z)U' + \dots + \tilde{h}_{d-1}(z)U^{(d-1)} + \tilde{h}_d(z)U^{(d)} \\ &\in K(z)U + K(z)U' + \dots + K(z)U^{(d-1)}, \end{aligned}$$

with polynomials $\tilde{h}_0(z), \dots, \tilde{h}_d(z) \in K[z]$ and the last member relation holds due to (10). By induction it holds for all $k \geq 0$ that

$$U^{(d+k)} \in K(z)U + K(z)U' + \dots + K(z)U^{(d-1)}.$$

(iii) \Rightarrow (i): Suppose

$$\dim_{K(z)} [K(z)U + K(z)U' + K(z)U'' + \dots] = d.$$

Thus $u, u', \dots, u^{(d)}$ are linearly dependent over $K(z)$. This dependence relation, after clearing the denominators so that the coefficients are polynomials in $K[z]$, results in an equation of the form (8). \square

Example 1.2.14. The following functions are holonomic:

1. $U_1 = \frac{z-2}{3z+4}$, as $(z-2)(3z+4)U_1' - 10U_1 = 0$.
2. $U_2 = e^z$, as $U_2' = U_2$, and $V_2 = \log(z)$, as $zV_2' = 1$ or alternatively in the form of (8): $zV_2'' + V_2' = 0$.
3. $U_3 = z^m e^{az}$, as $U_3' = (\frac{m}{z} + a)U_3$.
4. $U_4 = \cos(z)$, as $U_4'' = -U_4$. The same holds for $\sin(z)$.
5. $U_5 = \sum_{n \geq 0} n!z^n$, since $(zU_5)' = \sum_{n \geq 0} (n+1)!z^n$. This implies that $z(zU_5)' + 1 = U_5$ or reordered in the form of (9): $z^2U_5' + (z-1)U_5 = -1$.

We end this section with the proof of the missing link between holonomic and algebraic functions.

Theorem 1.2.15 ([174, Proposition 6.4.6]). *Let $U \in K[[z]]$ be algebraic of degree d , then U is holonomic.*

Proof. If $U(z)$ is algebraic, there is some polynomial $0 \neq P(z, y) \in K(z, y)$ of minimal degree such that $P(z, U) = 0$. We have

$$0 = \frac{d}{dz}P(z, U) = \left. \frac{\partial P(z, y)}{\partial z} \right|_{y=U} + U' \left. \frac{\partial P(z, y)}{\partial y} \right|_{y=U}.$$

Since $P(z, y)$ is of minimal degree, and therefore irreducible over $K(x)$, it follows that $\partial P(z, y)/\partial y$ is non-zero (remember $\text{char } K = 0$) and a polynomial in y of smaller degree than P , so $\left. \frac{\partial P(z, y)}{\partial y} \right|_{y=U} \neq 0$.

Hence, we get

$$U' = -\frac{\left. \frac{\partial P(z, y)}{\partial z} \right|_{y=U}}{\left. \frac{\partial P(z, y)}{\partial y} \right|_{y=U}} \in K(z, U).$$

In other words, U' is a rational function in z and U . By induction we get that $U^{(k)} \in K(z, U)$ for all $k \geq 0$. But due to the fact that U is algebraic, we get $\dim_{K(z)} K(z, U) = d$ and so it follows that $U, U', \dots, U^{(d)}$ are linearly dependent over $K(z)$. This yields an equation of the form (8), which proves that U is holonomic. \square

Example 1.2.16 ([174, Example 6.1]). Not all holonomic functions are algebraic. Consider $U(z) = e^z$: If it would be algebraic of degree d it would satisfy an equation of the form

$$P_d(z)e^{dz} + P_{d-1}(z)e^{(d-1)z} + \dots + P_1(z)e^z + P_0(z) = 0,$$

where $P_0(z), \dots, P_d(z) \in \mathbb{C}[z]$ and $P_d(z)$ is of minimal degree. Differentiating this equation and subtracting the initial one multiplied by d , gives

$$\begin{aligned} P'_d e^{dz} + (P'_{d-1} - P_{d-1}) e^{(d-1)z} + \dots \\ + (P'_1 - (d-1)P_1) e^z + (P'_0 - dP_0) = 0, \end{aligned}$$

which either has degree less than d , and contradicts the fact that $U(z)$ is algebraic of degree d , or the degree is the same, which contradicts the choice of $P_d(z)$ to be of minimal degree.

The class of holonomic function enjoys rich closure properties. Note that the following theorem mentions only the operations we are going to encounter in this thesis. For more details see [85, Theorem B.2].

Theorem 1.2.17. *The class of univariate holonomic functions is closed under the following operations: sum (+), product (\times), differentiation (∂_z), indefinite integration (\int^z) and algebraic substitution ($z \mapsto y(z)$ for some algebraic function $y(z)$).*

Proof. The proof is omitted here. A sketch of a proof can be found in [85, Theorem B.2], full details are discussed in [174, Chapter 6]. \square

The discussion so far only considered univariate or ordinary generating functions, i.e. functions in one variable. In order to encode more information, it is sometimes necessary to introduce more than one variable. This fact has already been used in the proof of Theorem 1.2.15. The necessary theory is presented in the next section.

Multivariate Generating Functions

So far we have only considered univariate formal power series, but this concept can easily be generalized to multivariate formal power series. In the same manner OGFs generalize to *multivariate generating functions* (MGFs). As Flajolet and Sedgewick put it [85, Chapter III], the main advantage of several variables is the possibility to keep track of a collection of parameters defined for combinatorial objects. Multivariate generating functions are applicable to many combinatorial

settings since the powerful symbolic method can be transferred to several variables in a straightforward way. Indeed, we can use the symbolic method not only to count combinatorial objects but also to *quantify* their properties.

In the case of lattice path combinatorics we will need the notion of a *bivariate generating function* (BGF), with the first parameter encoding the length of a lattice path, and the second parameter keeping track of the final height. This translates into

$$B(z, u) = \sum_{n,k \geq 0} b_{n,k} z^n u^k,$$

where $b_{n,k}$ is the number of lattice paths of length n and where the final height is equal to k . Note that it can also be interpreted as a formal power series in z with coefficients in $\mathbb{Q}[u]$, where for all n , almost all coefficients $b_{n,k}$ are zero. This interpretation closes the circle and links MGFs with OGFs.

We just want to remark that yet another generalization is the usage of formal Laurent⁹ series instead of formal power series. All definitions and observations stay the same and can be adapted to this new case in a straightforward way.

Example 1.2.18. We will continue the analysis from Example 1.2.7 of unrestricted paths \mathcal{W} starting from the origin and using the step set $\mathcal{S} = \{\mathbf{NE}, \mathbf{SE}\}$. We derived the following construction of the combinatorial class \mathcal{W}

$$\mathcal{W} = \mathcal{E} \cup \mathcal{W} \times \mathcal{Z}_{\mathbf{NE}} \cup \mathcal{W} \times \mathcal{Z}_{\mathbf{SE}}.$$

The difference now, is that we want to distinguish between **NE**- and **SE**-steps. A **NE**-step increases the height by one and hence corresponds to the generating function u and a **SE**-step decreases the height by one and hence corresponds to $\frac{1}{u}$. Additionally, both steps increase the length by 1. Note that we will work in the $\mathbb{Z}[u, 1/u]$ -module $\mathbb{Z}[[u, \frac{1}{u}]]$. Let us define the BGF associated with \mathcal{W} as

$$W_2(z, u) = \sum_{\substack{n \geq 0 \\ k \in \mathbb{Z}}} w_{n,k} z^n u^k.$$

This gives

$$W_2(z, u) = 1 + uzW_2(z, u) + \frac{z}{u}W_2(z, u).$$

Solving this equation for $W_2(z, u)$ results in

$$W_2(z, u) = \frac{1}{1 - z(u + \frac{1}{u})}.$$

⁹ A Laurent series $H(z)$ is a function such that there exists an integer k such that $z^k H(z)$ is a power series.

Next we will perform a coefficient extraction in order to get $w_{n,k}$, the number of walks of length n stopping at height k :

$$[z^n]W_2(z, u) = \left(u + \frac{1}{u}\right)^n.$$

This is a Laurent polynomial in u . Now we apply the shift identity of the coefficient extraction (1) to get

$$\begin{aligned} w_{n,k} &= [u^k] \left(u + \frac{1}{u}\right)^n = [u^{n+k}] (u^2 + 1)^n \\ &= \begin{cases} 0, & \text{for } n+k \equiv 1 \pmod{2}, \text{ or } k > n, \\ \binom{n}{\frac{n+k}{2}}, & \text{for } n+k \equiv 0 \pmod{2}. \end{cases} \end{aligned}$$

Note that the BGF can be easily transformed into the OGF we found in Example 1.2.7, by substituting $u = 1$. This action sums over all possible heights at fixed length n :

$$\begin{aligned} W_2(z, 1) &= \frac{1}{1-2z} = W(z), \\ \sum_{k \in \mathbb{Z}} w_{n,k} &= \sum_{k=-n, -n+2, \dots, n} \binom{n}{\frac{n+k}{2}} = \sum_{k=0}^n \binom{n}{k} = 2^n. \end{aligned}$$

In general, we have to be careful here. We are only dealing with formal power series, which is the reason why insertion of special values for variables is in general not well-defined. So, we have to ensure that all operations are legitimate, e.g.: there are no singularities and all sums are finite, etc.

The classification of multivariate formal power series can be directly generalized from the univariate case. We will not go into more detail here. The interested reader is referred to [85, Theorem B.3].

Asymptotic Notation

These definitions are taken from [85, Chapter A.2], where more examples can be found.

Let S be a set and $s_0 \in S$. We assume a notion of neighborhood to exist in S , e.g. $S = \mathbb{C}$ and $s_0 = 0$. Two functions $f, g : S \setminus \{s_0\} \rightarrow \mathbb{R}(\mathbb{C})$ are given.

- *\mathcal{O} -notation:* Denote

$$f(s) \underset{s \rightarrow s_0}{=} \mathcal{O}(g(s)),$$

if the ratio $f(s)/g(s)$ stays bounded as $s \rightarrow s_0$ in S . In other words, there exists a neighborhood V of s_0 and a constant $C > 0$, such that

$$|f(s)| \leq C|g(s)|, \quad s \in V, s \neq s_0.$$

This is also known as “Big-O-notation”.

- *~-notation*: Denote

$$f(s) \underset{s \rightarrow s_0}{\sim} g(s),$$

if the ratio $f(s)/g(s)$ tends to 1 as $s \rightarrow s_0$ in S . One also says f and g are *asymptotically equivalent* (as s tends to s_0). We will mostly use this notation for $s_0 = \infty$.

- *o-notation*: Denote

$$f(s) \underset{s \rightarrow s_0}{=} o(g(s)),$$

if the ratio $f(s)/g(s)$ tends to 0 as $s \rightarrow s_0$ in S . In other words, for any $\varepsilon > 0$, there exists a neighborhood V of s_0 , such that

$$|f(s)| \leq \varepsilon |g(s)|, \quad s \in V, s \neq s_0.$$

This is also known, as “little-o-notation”.

Coefficient Asymptotics

The *Gamma function* extends the factorial function to non-integral arguments. It was introduced by Euler as

$$\Gamma(s) = \int_0^{\infty} e^{-t} t^{s-1} dt.$$

The integral converges provided $\Re(s) > 0$. Using integration by parts one immediately derives the basic functional equation of the Gamma function,

$$\Gamma(s+1) = s\Gamma(s).$$

Since $\Gamma(1) = 1$ one directly gets $\Gamma(n+1) = n!$. The special value $\Gamma(1/2) = \sqrt{\pi}$ proves to be very important. Also its asymptotic properties will be needed:

Proposition 1.2.19 (Stirling’s formula, [85, p. 747]). *The factorial function admits for $x \rightarrow +\infty$ the asymptotic expansion:*

$$x! \equiv \Gamma(x+1) \sim \left(\frac{x}{e}\right)^x \sqrt{2\pi x} \left(1 + \frac{1}{12x} + \frac{1}{288x^2} - \frac{139}{51840x^3} - \dots\right).$$

Example 1.2.20. A direct consequence of Stirling’s formula is the asymptotic expansion

$$C_n = \frac{1}{n+1} \binom{2n}{n} \sim \frac{4^n}{\sqrt{\pi n^3}} \left(1 - \frac{9}{8n} + \frac{145}{128n^2} - \frac{1155}{1024n^3} + \dots\right), \quad (11)$$

of the Catalan numbers C_n .

At the heart of the asymptotic enumeration lie the following fundamental theorems. The main idea is to treat generating functions not only as formal power series, but as converging power series in a certain domain of convergence. By doing so, one may utilize the wealth of results from complex analysis to derive formulae on the asymptotics of the coefficients. For the proofs and more details, the interested reader is referred to [85] and the literature mentioned therein.

Theorem 1.2.21 ([85, Theorem VI.1], Standard function scale). *Let α be an arbitrary complex number in $\mathbb{C} \setminus \mathbb{Z}_{\leq 0}$. The coefficient of z^n in*

$$f(z) = (1 - z)^{-\alpha}$$

admits for large n a complete asymptotic expansion in descending powers of n ,

$$[z^n]f(z) \sim \frac{n^{\alpha-1}}{\Gamma(\alpha)} \left(1 + \sum_{k=1}^{\infty} \frac{e_k}{n^k} \right),$$

where e_k is an explicitly known polynomial in α of degree $2k$. In particular:

$$[z^n]f(z) \sim \frac{n^{\alpha-1}}{\Gamma(\alpha)} \left(1 + \frac{\alpha(\alpha-1)}{2n} + \mathcal{O}\left(\frac{1}{n^2}\right) \right).$$

Proof (Sketch). This result can be obtained directly from the closed-form expression of the coefficients $\binom{n+\alpha-1}{n}$ by means of Stirling's formula.

An alternative approach is given in [85, Theorem VI.1] by using Cauchy's coefficient formula and a properly chosen contour, a so called Hankel contour. Then, asymptotic estimates lead to the result. \square

Theorem 1.2.22 ([85, Theorem VI.2], Standard function scale, logarithms). *Let α be an arbitrary complex number in $\mathbb{C} \setminus \mathbb{Z}_{\leq 0}$, and β be an arbitrary complex number $\mathbb{C} \setminus \mathbb{Z}_{\geq 0}$. The coefficient of z^n in*

$$f(z) = (1 - z)^{-\alpha} \left(\frac{1}{z} \log \frac{1}{1 - z} \right)^{\beta}$$

admits for large n a complete asymptotic expansion in descending powers of n ,

$$[z^n]f(z) \sim \frac{n^{\alpha-1}}{\Gamma(\alpha)} (\log n)^{\beta} \left(1 + \sum_{k=1}^{\infty} \frac{C_k}{(\log n)^k} \right),$$

where $C_k = \binom{\beta}{k} \Gamma(\alpha) \left. \frac{d^k}{ds^k} \frac{1}{\Gamma(s)} \right|_{s=\alpha}$.

The asymptotic results of the previous theorem for some standard functions are summarized in Figure 60 on page 323. These results will mostly suffice in the subsequent examples.

In order to also transfer the error terms of the coefficient asymptotics we need the next (technical) definition.

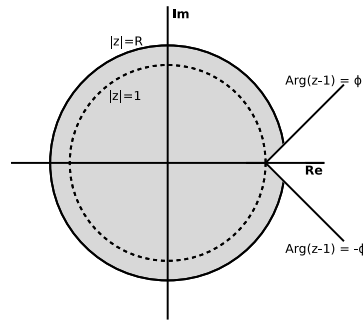

Figure 10: Sketch of a Δ -domain.

Definition 1.2.23 (Δ -analytic). *Given two numbers ϕ, R with $R > 1$ and $0 < \phi < \frac{\pi}{2}$, the open domain $\Delta(\phi, R)$ is defined as*

$$\Delta(\phi, R) = \{z \mid |z| < R, z \neq 1, |\arg(z - 1)| > \phi\}.$$

A domain is a Δ -domain at 1 if it is a $\Delta(\phi, R)$ for some R and ϕ . For a complex number $\zeta \neq 0$, a Δ -domain at ζ is the image by the mapping $z \mapsto \zeta z$ of a Δ -domain at 1. A function is Δ -analytic if it is analytic in some Δ -domain.

For an illustration of a Δ -domain, see Figure 10.

Theorem 1.2.24 ([85, Theorem VI.3], Transfer, Big-O and little-o). *Let α, β be arbitrary real numbers, $\alpha, \beta \in \mathbb{R}$ and let $f(z)$ be a function that is Δ -analytic.*

1. *Assume that $f(z)$ satisfies in the intersection of a neighborhood of 1 with its Δ -domain the condition*

$$f(z) = \mathcal{O}\left((1 - z)^{-\alpha} \left(\log \frac{1}{1 - z}\right)^\beta\right).$$

Then one has: $[z^n]f(z) = \mathcal{O}(n^{\alpha-1}(\log n)^\beta)$.

2. *Assume that $f(z)$ satisfies in the intersection of a neighborhood of 1 with its Δ -domain the condition*

$$f(z) = o\left((1 - z)^{-\alpha} \left(\log \frac{1}{1 - z}\right)^\beta\right).$$

Then one has: $[z^n]f(z) = o(n^{\alpha-1}(\log n)^\beta)$.

The last three theorems lie at the heart of coefficient asymptotics and define the so-called *singularity analysis*. The next proposition summarizes this process and presents an “algorithm” to deal with such functions. We want to emphasize the fact that the structure of the generating function is used to derive results on its coefficients.

Proposition 1.2.25 ([85, Chapter VI.4], Process of singularity analysis). *Let $f(z)$ be a function analytic at 0 whose coefficients are to be asymptotically analyzed.*

1. Preparation: *Locate dominant singularities and check analytic continuation.*
 - a) Locate singularities: *Determine the dominant singularities of $f(z)$ and check that $f(z)$ has a single singularity ρ on its circle of convergence.*
 - b) Check continuation: *Establish that $f(z)$ is analytic in some Δ -domain around ρ .*
2. Singular expansion: *Analyze the function $f(z)$ as $z \rightarrow \rho$ in the Δ -domain and determine an expansion of the form*

$$f(z) = \sigma(z/\rho) + \mathcal{O}(\tau(z/\rho)), \quad \text{with} \quad \tau(z) = o(\sigma(z)),$$

for $z \rightarrow \rho$. The functions σ and τ should belong to the standard scale of functions given by the set $\mathcal{S} = \{(1-z)^{-\alpha} \lambda(z)^\beta\}$, with $\lambda(z) := z^{-1} \log(1-z)^{-1}$.

3. Transfer: *Translate the main term of $\sigma(z)$ using the catalogs provided by Theorems 1.2.21 and 1.2.22. Transfer the error term using Theorem 1.2.24 and conclude that*

$$[z^n]f(z) = \rho^{-n} \sigma_n + \mathcal{O}(\rho^{-n} \tau_n),$$

for $n \rightarrow \infty$, where $\sigma_n = [z^n]\sigma(z)$ and $\tau_n = [z^n]\tau(z)$ provided the corresponding exponent $\alpha \notin \mathbb{Z}_{\leq 0}$ (otherwise the factor $1/\Gamma(\alpha) = 0$ should be omitted).

Example 1.2.26. Using Theorem 1.2.21 there is another possibility to derive the asymptotic expansion of Catalan numbers. From (6) we know the generating function of Catalan numbers. Its dominant singularity is at $\rho = \frac{1}{4}$. Thus, we get the asymptotic expansion

$$D(z) = 2 - 2\sqrt{1-4z} + 2(1-4z) + \mathcal{O}\left((1-4z)^{3/2}\right).$$

Thus, applying Theorems 1.2.21 and 1.2.24 we recover the first term of (11):

$$[z^n]D(z) = \frac{4^n}{\sqrt{\pi n^3}} \left(1 + \mathcal{O}\left(\frac{1}{n}\right)\right).$$

Note that the full asymptotic expansion can also be derived from this expression.

1.3 ŁUKASIEWICZ PATHS

As an introduction to lattice path theory, we are going to consider *directed paths*. These are paths with a fixed direction of increase which we choose to be the positive horizontal axis. This is described by the allowed steps: if $(i, j) \in \mathcal{S}$ then $i > 0$. One first important observation

is that the geometric realization of the path always lives in the right half-plane $\mathbb{Z}_+ \times \mathbb{Z}$. This essentially means that directed paths are one-dimensional objects.

The following chapter mainly focuses on the expositions of Banderier¹⁰ and Flajolet given in [19].

Definition 1.3.1. *In accordance with these restrictions, we introduce the following classes (see Table 1):*

- A bridge is a path whose end-point ω_n lies on the x-axis;
- A meander is a path that lies in the quarter plane \mathbb{Z}_+^2 ;
- An excursion is a path that is at the same time a meander and a bridge, i.e. it connects the origin with a point lying on the x-axis and involves no point with negative y-coordinate.

Additionally, we call a family of paths or steps to be simple if each allowed step in \mathcal{S} is of the form $(1, b)$ with $b \in \mathbb{Z}$. In other words, these walks constantly move one step to the right. We introduce the abbreviation $\mathcal{S} = \{b_1, \dots, b_m\}$ in this case.

A Łukasiewicz path is a simple path, its associated step set \mathcal{S} is a subset of $\{-1, 0, 1, \dots\}$, and $-1 \in \mathcal{S}$.

	ending anywhere	ending at 0
unconstrained (on \mathbb{Z})	 walk/path (\mathcal{W}) $W(z) = \frac{1}{1-zP(1)}$	 bridge (\mathcal{B}) $B(z) = z \frac{u_1'(z)}{u_1(z)}$
constrained (on \mathbb{Z}_+)	 meander (\mathcal{M}) $M(z) = \frac{1-u_1(z)}{1-zP(1)}$	 excursion (\mathcal{E}) $E(z) = \frac{u_1(z)}{p_{-1}z}$

Table 1: The four types of paths: walks, bridges, meanders and excursions, and the corresponding generating functions for Łukasiewicz paths [19, Fig. 1]. $P(u)$ is the jump polynomial of Definition 1.3.3, and $u_1(z)$ is the unique solution of $1 - zP(u) = 0$ with $\lim_{z \rightarrow 0} u_1(z) = 0$.

In the remainder of this section, we will focus on Łukasiewicz paths. These are well-studied objects and possess a lot of applications. Their importance stems from the famous Łukasiewicz correspondence between

¹⁰ Cyril Banderier, 19.5.1975-

trees and lattice paths, see Figure 11. This shows the huge variety of this class. In this sense, we encounter here the first instance of “tree-like” objects.

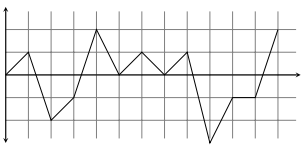
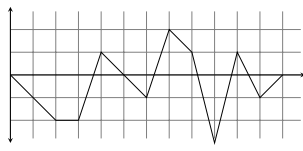
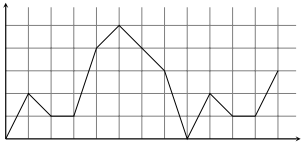
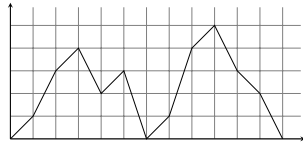
Two famous members of this class are the already introduced Dyck paths, and Motzkin paths.

Definition 1.3.2. A Motzkin path is a path that starts at the origin and is given by the step set $\mathcal{S} = \{-1, 0, +1\}$.

We will refer to Motzkin walks/meanders/bridges/excursions depending on the different restrictions. In common literature Motzkin paths are often defined as Motzkin excursions, e.g. in [63].

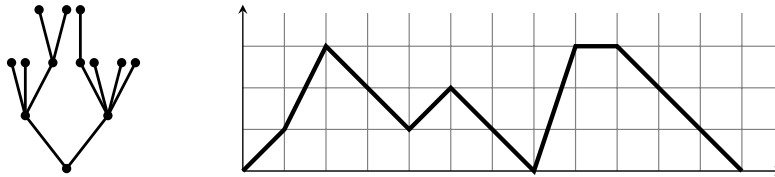

Figure 11: The Łukasiewicz bijection between trees and lattice paths: A little fly is traveling along the full contour of the tree starting from the root. Whenever it meets a new node, one draws a new jump of size “arity of the node -1 ” in the lattice path. Without loss of generality, one can always remove the very last jump (as it will always be a “ -1 ”) and thus we get an excursion which is in bijection with the initial tree. It is straightforward to reverse this bijection. Additionally, note that any deterministic traversal of the tree offers such a bijection, so it could be a depth-first traversal, but also e.g. a breadth-first traversal.

Walks and Bridges

The first cases we are going to consider are the unconstrained walks and bridges. First we introduce the algebraic structures associated with the previous definitions. The following definition is the algebraic link between weights and steps.

Definition 1.3.3. The jump polynomial of \mathcal{S} is defined as the polynomial in u, u^{-1} (a Laurent polynomial)

$$P(u) := \sum_{j=1}^m p_j u^{s_j}.$$

Let $c = -\min_j s_j$ and $d = \max_j s_j$ be the two extreme jump sizes, and assume throughout $c, d > 0$ to avoid trivial cases. The kernel equation is defined by

$$1 - zP(u) = 0, \quad \text{or equivalently} \quad u^c - z(u^c P(u)) = 0.$$

The quantity $K(z, u) := u^c - zu^c P(u)$ is called kernel.

Note that for Łukasiewicz paths we have $c = 1$. In order to count the number of walks, one sets all weights equal to 1. Thereby every walk has weight 1.

Let $w_{n,k}$ be the number of paths ending after n steps at altitude k . We define the associated generating function as

$$W(z, u) := \sum_{n \geq 0, k \in \mathbb{Z}} w_{n,k} z^n u^k.$$

Note that we are mainly interested in solving the counting problem, i.e. determining the numbers $w_{n,k}$ for certain families of paths (compare e.g. Figure 1). The generating function encodes all information we are interested in. The following variant of [19, Theorem 1] makes this explicit.

Theorem 1.3.4. *The bivariate generating function of paths (z marking size and u marking final altitude) relative to a simple step set \mathcal{S} with characteristic polynomial $P(u)$ is a rational function. It is given by*

$$W(z, u) = \frac{1}{1 - zP(u)}.$$

The generating function of bridges is an algebraic function given by

$$B(z) = z \frac{u_1'(z)}{u_1(z)}, \quad (12)$$

where $u_1(z)$ is the unique solution of the kernel equation $1 - zP(u) = 0$ with $\lim_{z \rightarrow 0} u_1(z) = 0$.

Example 1.3.5 (Dyck Bridges). The step set $\mathcal{S} = \{\mathbf{NE}, \mathbf{SE}\}$, or equivalently $\mathcal{S} = \{+1, -1\}$, corresponds to the walks of *Dyck bridges*. The characteristic polynomial is $P(u) = u^{-1} + u$, and hence the kernel equation reads

$$1 - z \left(\frac{1}{u} + u \right) = 0.$$

We see immediately from the step set that $c = 1$ and $d = 1$. Therefore, the kernel equation is of degree 2:

$$u - z(1 + u^2) = 0.$$

There exists one small branch ($\lim_{z \rightarrow 0} u_1(z) = 0$) and one large branch ($\lim_{z \rightarrow 0} |v_1(z)| = +\infty$). In this case, they can be easily computed, by solving the equation of degree 2:

$$u_1(z) = \frac{1 - \sqrt{1 - 4z^2}}{2z} \underset{z \rightarrow 0}{\sim} z, \quad v_1(z) = \frac{1 + \sqrt{1 - 4z^2}}{2z} \underset{z \rightarrow 0}{\sim} \frac{1}{z}. \quad (13)$$

We used the fact that $\sqrt{1-4z^2} = \sum_{n \geq 0} \binom{1/2}{n} (-4)^n z^{2n}$ in a small neighborhood of 0. Now we apply Theorem 1.3.4 which gives the generating function for bridges:

$$B(z) = z \frac{u_1'(z)}{u_1(z)} = \frac{1}{\sqrt{1-4z^2}} = 1 + 2z^2 + 6z^4 + 70z^8 + 252z^{10} + \dots$$

The coefficients are known as OEIS [A000984](#)

$$[z^n]B(z) = \binom{2n}{n} = [t^n](1+t^2)^n, \quad (14)$$

and called *central binomial numbers*. They are closely related to the Catalan numbers. This result can be explained very easily: In order to uniquely characterize a Dyck bridge consisting of n **NE**-steps and n **SE**-steps, we simply need to choose the positions of the **NE**-steps (or equivalently of the **SE**-steps). For this, there are $\binom{2n}{n}$ possibilities.

Meanders and excursions

Let $f_{n,k}$ be the number of meanders ending after n steps at altitude k . We define the associated generating function as

$$F(z, u) := \sum_{n,k} f_{n,k} z^n u^k = \sum_{k \geq 0} F_k(z) u^k = \sum_{n \geq 0} f_n(u) z^n.$$

Firstly, the generating functions $F_k(z)$ represent meanders ending at altitude k , i.e. $F_k(z) = \sum_{n \geq 0} f_{n,k} z^n$. Thus, the generating function of excursions is equal to $F_0(z)$. Secondly, the polynomials $f_n(u)$ represent meanders of length n . The powers of u encode their possible final altitudes.

Theorem 1.3.6. *Let \mathcal{S} be the step set of a Łukasiewicz path, and $P(u)$ be the associated step polynomial. The bivariate generating function of meanders (where z marks length, and u marks final altitude) and excursions, respectively, are*

$$F(z, u) = \frac{1 - u_1(z)/u}{1 - zP(u)} \quad \text{and} \quad E(z) = \frac{u_1(z)}{p_{-1}z}, \quad (15)$$

where $u_1(z)$ is the unique solution of the implicit equation

$$1 - zP(u) = 0,$$

which fulfills $\lim_{z \rightarrow 0} u_1(z) = 0$.

Proof. A meander or excursion of length n is either empty, or it is constructed from a walk of length $n-1$ by appending a possible step from \mathcal{S} . However, a walk is not allowed to go below the x -axis, thus at altitude $u=0$ it is not allowed to use the step -1 . This translates into

$$f_0(u) = 1, \quad f_{n+1}(u) = \{u \geq 0\} (P(u) f_n(u)),$$

where $\{u^{\geq 0}\}$ is the linear operator extracting all terms in the power series representation containing non-negative powers of u . Multiplying by z^{n+1} and summing over all $n \geq 0$ we derive the following functional equation where $F_0(z) = E(z)$

$$F(z, u) = 1 + zP(u)F(z, u) - \frac{p-1z}{u}F_0(z),$$

and we get

$$(1 - zP(u))F(z, u) = 1 - \frac{p-1z}{u}F_0(z), \quad (16)$$

where $K(z, u) := 1 - zP(u)$ is called the *kernel*. This functional equation is under-determined as there are two unknown functions, namely $F(z, u)$ and $F_0(z)$. However, the special structure on the left-hand side will resolve this problem and leads us to the *kernel method*.

From the theory of Newton–Puiseux expansions, the fundamental result in the theory of algebraic curves [1, 143], we know that the *kernel equation*

$$1 - zP(u) = 0,$$

has $d + 1$ ($c = 1$) distinct solutions in u , with 1 of them being called “small branch”, as it maps 0 to 0 and is in modulus smaller than the other d “large branches” which grow in modulus to infinity while approaching 0. We call the small branch $u_1(z)$ and the large ones $v_1(z), \dots, v_d(z)$. For these functions to be well-defined we restrict our attention to the complex plane slit along the negative real axis. Inserting the small branch into (16) we get

$$F_0(z) = \frac{u_1(z)}{p-1z}.$$

Using this result we can solve (16) for $F(z, u)$. □

Remark 4 (Brief history of the kernel method). The main idea of the proof of Theorem 1.3.6 was to solve the functional equation (16) by the *kernel method*, which consists of binding z and u in such a way that the left-hand side vanishes. Compare with [126, Exercise 2.2.1.1-4] as the first source, or with [50] for a combinatorial and analytic treatment, or with [19, p. 56] for the strongly related Wiener-Hopf approach from probability theory. For more details we refer to the summary of historical notes at the end of [19, Section 2.3].

Let us briefly show in the next two subsections how this result can be used to derive classical results for Dyck paths and Motzkin paths.

A key tool giving a formula for the coefficients of power series satisfying this type of equation is the Lagrange inversion formula (1768), extended by Bürmann in 1798:

Theorem 1.3.7 (Lagrange–Bürmann inversion). *Let us consider a power series $F(z)$ which satisfies $F(z) = z\phi(F(z))$ with $\phi(z)$ a power series such that $\phi(0) \neq 0$. (We will call such an equation a Lagrangean equation.) Then, for any Laurent power series H , one has for all $n \in \mathbb{Z}$, $n \neq 0$:*

$$[z^n]H(F(z)) = \frac{1}{n}[z^{n-1}]H'(z)\phi(z)^n.$$

Proof. See [85, chapter A.6] or [174, Theorem 5.4.2]. \square

Example 1.3.8 (Dyck paths and the ballot problem). Continuing Example 1.3.5, Dyck paths are excursions with the step set $\mathcal{S} = \{-1, 1\}$. The associated step polynomial is

$$P(u) = \frac{1}{u} + u.$$

We may directly apply Theorem 1.3.6 as we have already computed the small and the large branches in (13) and recover the generating function of Dyck paths from (6):

$$E(z) = \frac{1 - \sqrt{1 - 4z^2}}{2z^2} = \sum_{n \geq 0} \frac{1}{n+1} \binom{2n}{n} z^{2n} = \sum_{n \geq 0} C_n z^{2n},$$

where the coefficients C_n are the Catalan numbers.

Recall from the introduction that the *ballot problem* asks for the probability in a two candidate election between A and B that eventually ends in a tie, while A is dominating B throughout the poll. This problem can be modeled as a lattice path starting from the origin, with the steps **NE** representing a vote for candidate A and **SE** being a vote for candidate B . The fact that it ends in a tie, translates into a walk that ends on the x -axis, and the condition of A dominating B is modeled by the restriction that the walk must not leave the first quadrant. Hence, we are dealing with a Dyck path.

The total number of possible walks from $(0, 0)$ to $(2n, 0)$ is $\binom{2n}{n}$, which are the number of bridges with respect to this step set, compare (14). Thus,

$$\mathbb{P}[\text{tie, } A \text{ dominates } B \text{ throughout}] = \begin{cases} \frac{1}{n+1}, & 2n \text{ votes,} \\ 0, & 2n+1 \text{ votes,} \end{cases}$$

is the asked probability.

Example 1.3.9. Consider the step set $\mathcal{S} = \{-1, 0, 1, 2\}$. There will be one small branch of order 1 and two large branches of order $-1/2$. The entire version of the characteristic equation is

$$u - z(1 + u + u^2 + u^3) = 0.$$

The one small branch is given by

$$u_1(z) = z + z^2 + 2z^3 + 5z^4 + 13z^5 + 36z^6 + 104z^7 + 309z^8 + \dots,$$

and the two large branches are conjugate

$$\begin{aligned} v_1(z) &= z^{1/2} - \frac{1}{2} - \frac{3}{8}z^{1/2} - \frac{1}{2}z - \frac{41}{128}z^{3/2} - \frac{1}{2}z^2 - \frac{763}{1024}z^{3/2} - z^3 + \dots, \\ v_2(z) &= -z^{1/2} - \frac{1}{2} + \frac{3}{8}z^{1/2} - \frac{1}{2}z + \frac{41}{128}z^{3/2} - \frac{1}{2}z^2 + \frac{763}{1024}z^{3/2} - z^3 + \dots \end{aligned}$$

The first few terms of the generating function for excursions are easily computed by (15):

$$E(z) = \frac{u_1(z)}{z} = 1 + z + 2z^2 + 5z^3 + 13z^4 + 36z^5 + 104z^6 + \dots,$$

and similarly for meanders:

$$M(z) = \frac{1 - u_1(z)}{1 - 4z} = 1 + 3z + 11z^2 + 42z^3 + 163z^4 + 639z^5 + \dots$$

Let us end this section with a summary of some well-known lattice path enumeration problems. We state the specific step set, the kernel, and the generating function of excursions.

- *Dyck paths*: Step set $\mathcal{S} = \{(1, -1), (1, 1)\}$ associated with the kernel $K(z, u) = u - zu^2 - z$,

$$E(z) = \frac{1 - \sqrt{1 - 4z^2}}{2z^2}.$$

- *Motzkin paths*: Step set $\mathcal{S} = \{(1, -1), (1, 1), (1, 0)\}$ associated with the kernel $K(z, u) = u - zu^2 - z - zu$,

$$E(z) = \frac{1 - z - \sqrt{1 - 2z - 3z^2}}{2z^2}.$$

- *Schröder paths*: Step set $\mathcal{S} = \{(1, -1), (1, 1), (2, 0)\}$ associated with the kernel $K(z, u) = u - zu^2 - z - z^2u$,

$$E(z) = \frac{1 - z^2 - \sqrt{1 - 6z^2 + z^4}}{2z^2}.$$

- *Delannoy paths*: Step set $\mathcal{S} = \{(1, 0), (0, 1), (1, 1)\}$ associated with the kernel $K(z, u) = 1 - z - zu - u$,

$$E(z) = \frac{1}{1 - z}, \quad \left(F(z, u) = \frac{z + zu + u}{1 - z - zu - u} \right).$$

We want to emphasize that not all problems need to have rational or algebraic solutions. There are also problems which have an irrational and maybe even non-holonomic solution. One example is the *Knight's Walk* studied in detail in [50]. Hereby we understand a walk that starts anywhere on the lines $x = 0, 1$ or $y = 0, 1$, takes only two kinds of steps $(-1, 2)$ and $(2, -1)$ and remains in the region $x \geq 2, y \geq 2$ once it leaves the starting point.

1.4 MARKING IN COMBINATORIAL CONSTRUCTIONS

Let \mathcal{A} be a combinatorial class. Recall that \mathcal{A}_n consists of all elements of \mathcal{A} of size n , and its cardinality $|\mathcal{A}_n|$ is given by a_n . In the context of this thesis we call an object *random* if it is drawn *uniformly at random* among all elements of \mathcal{A}_n . In other words, every element $\alpha \in \mathcal{A}_n$ is assigned the probability (i.e. weight) $1/a_n$. We will use the symbol \mathbb{P} to denote probability.

In Section 1.2 we introduced bivariate generating functions. They are especially useful if a certain parameter χ is of interest. For example this could be the number of returns to zero, or the final altitude in the case of lattice paths. A d -dimensional parameter χ on a combinatorial class \mathcal{A} is a function that maps an element $\alpha \in \mathcal{A}$ to a d -tuple $\chi(\alpha) \in \mathbb{N}^d$.

In the context of multivariate generating functions this translates into

$$A(z, \mathbf{u}) = \sum_{\alpha \in \mathcal{A}} \mathbf{u}^{\chi(\alpha)} z^{|\alpha|},$$

where $\mathbf{u} := (u_1, \dots, u_d)$ and $\mathbf{u}^{k_1, \dots, k_d} := u_1^{k_1} \cdots u_d^{k_d}$.

For multivariate generating functions there exists an extension of the symbolic method. We will introduce some tools in Chapter 2. For more details we refer to [85, 153].

We will mostly encounter 1-dimensional parameters. Then the bivariate generating function reads

$$A(z, u) = \sum_{n \geq 0} \sum_{k \geq 0} a_{n,k} u^k z^n,$$

where $a_{n,k}$ is the number of combinatorial objects of size n with $\chi = k$. We say the variable z *marks* the size, and the variable u *marks* χ . For every $n \in \mathbb{N}$ this parameter defines a discrete random variable X_n by setting

$$\mathbb{P}[X_n = k] = \frac{a_{n,k}}{a_n} = \frac{a_{n,k}}{\sum_{k \geq 0} a_{n,k}}.$$

Before we continue, we will briefly recall two important definitions.

Definition 1.4.1 (Expected value). *The expected value or mean of a discrete random variable X is defined as*

$$\mathbb{E}(X) := \mu := \sum_k \mathbb{P}[X = k] \cdot k.$$

An important feature of the mean is its linearity.

Definition 1.4.2 (Variance). *The variance of a discrete random variable X is defined as*

$$\mathbb{V}(X) := \mathbb{E}((X - \mu)^2) = \mathbb{E}(X^2) - \mu^2.$$

The standard deviation σ is defined by $\sqrt{\mathbb{V}(X)}$.

Probability generating functions

Generating functions also prove very useful in the analysis of a random variable X_n . This class is called *probability generating functions*. It is the ordinary generating function of the sequence of probabilities $(\mathbb{P}[X_n = k])_{k \geq 0}$ given by

$$p_n(u) := \sum_{k \geq 0} \mathbb{P}[X_n = k] u^k.$$

The bivariate generating function $A(z, u)$ where z marks the size and u marks the parameter χ is closely related to $p_n(u)$. In particular, we have

$$p_n(u) = \frac{[z^n]A(z, u)}{[z^n]A(z, 1)}.$$

Thus, understanding the bivariate generating function $A(z, u)$ gives access to the random variable X_n .

If $p_n(u)$ exists in a neighborhood of $u = 1$, it can be used to compute the *factorial moments*

$$\mathbb{E}(X_n^r) := \mathbb{E}(X_n(X_n - 1) \cdots (X_n - r + 1)).$$

It is given by the r -th differentiation at $u = 1$:

$$\mathbb{E}(X_n^r) = \left. \frac{d^r}{du^r} p_n(u) \right|_{u=1}.$$

In particular the variance of X_n is given by

$$\mathbb{V}(X_n) = p_n''(1) + p_n'(1) - (p_n'(1))^2.$$

1.5 BASIC PARAMETERS OF DYCK PATHS

In this section we want to show how one can apply the concept of marking in order to get a deeper insight on certain parameters. In order to present the concept as clearly as possible we restrict ourselves to Dyck paths and consider the number of contacts of excursions and the expected final altitude of meanders.

Arches and contacts

Define an *arch* as an excursion of size > 0 whose only contact with the x -axis is at its end points and let \mathcal{A} be the set of arches. The set \mathcal{D} of excursions satisfies the combinatorial equation

$$\mathcal{D} = \text{SEQ}(\mathcal{A}),$$

where SEQ denotes the operator for the combinatorial construction that forms sequences, compare (2). By the symbolic method this translates directly into the generating function equation

$$E(z) = \frac{1}{1 - A(z)}, \quad \text{or equivalently} \quad A(z) = 1 - \frac{1}{E(z)}. \quad (17)$$

Define a vertex of an excursion not equal to one of the end points to be a *contact* if its altitude is 0. Then, $A(z)^{k+1}$ is the generating function of excursions having k contacts.

The next theorem gives the result for the number of contacts. We will encounter a *negative binomial distribution*, where we say that a random variable X is distributed according to $\text{NB}(r, p)$ if

$$\mathbb{P}[X = k] = \binom{k+r-1}{k} p^k (1-p)^r.$$

It represents the number of unsuccessful trials k until the r^{th} success in independent Bernoulli experiments with probability p .

Theorem 1.5.1. *The probability that a random Dyck path of size n has k contacts is for any fixed k of the form*

$$\frac{1}{4}(k+1) \left(\frac{1}{2}\right)^k + \mathcal{O}\left(\frac{1}{n}\right).$$

The number of contacts is thus asymptotically distributed like a negative binomial distribution with parameters 2 and 1/2, i.e. $\text{NB}(2, 1/2)$.

Proof. The probability that a Dyck path of length n chosen uniformly at random has k contacts is

$$\frac{1}{C_n} [z^n] A(z)^{k+1}.$$

As we are interested in the probability for large n , we want to derive the asymptotics of these numbers for fixed k . The asymptotics of the Catalan numbers C_n has been well studied before in e.g. (11). Thus, what remains is to apply singularity analysis to $A(z)^{k+1}$. From (17) and the result for Dyck paths from Example 1.3.8 we get that

$$\begin{aligned} A(z)^{k+1} &= \left(\frac{1}{2} - \frac{1}{2}\sqrt{1-4z}\right)^{k+1} \\ &= \frac{1}{2^{k+1}} - (k+1)\frac{1}{2^{k+1}}\sqrt{1-4z} + \mathcal{O}(1-4z). \end{aligned}$$

Its dominant singularity is at $1/4$, with the above singular expansion at that point. Thus, Theorems 1.2.21 and 1.2.24 combined with Figure 60 directly yield the result. \square

Expected final altitude

Let us consider *Dyck meanders*. Thereby we understand paths constructed from the step set $\mathcal{S} = \{-1, 1\}$ constrained to stay above or on the x -axis. In other words we drop the condition of Dyck paths to end on the x -axis, and consider meanders instead of excursions.

Theorem 1.5.2. *The generating function $G(z, u)$ ($U(z, u)$) of Dyck meanders of even (odd) length, with z marking twice the steps (twice minus 1 the steps), and u marking the final altitude is*

$$G(z, u) = \frac{D(z)}{1 - z(uD(z))^2}, \quad U(z, u) = uD(z)G(z, u),$$

where $D(z) = \frac{1 - \sqrt{1 - 4z}}{2z}$ is the generating function of Dyck paths.

Proof. Let us start with even length. First, note that paths of even length must end at an even altitude.

We uniquely decompose the path by the last times it leaves a given altitude. This is a so-called *last passage decomposition* (compare first passage decomposition in Example 1.2.8). Note that in $D(z)$ the power of z counts the number of pairs of up and down steps. In order to reach an even altitude a walk must have an even number more up than down steps. Thus, we may group 2 consecutive of these last up steps and count them by z . Going from altitude k to altitude $k + 2$, where the first jump leaves altitude k for the last time, can be modeled by $z(uD(z))^2$.

The last passage decomposition shows that a meander is thus given by a Dyck path followed by a sequence of the previous objects. This yields the formula for $G(z, u)$.

Moreover, a path ending at an odd altitude can be uniquely decomposed into a Dyck path followed by an up jump followed by a Dyck meander ending at an even altitude. Thus, we get the formula for $U(z, u)$. \square

Let us now consider a probability distribution on the set of meanders of length n . The combinatorial probability model (or uniform distribution among elements of size n) is given by drawing uniformly at random an element of the given class.

Let X_n be the random variable of paths of length n ending at altitude k . Then we have

$$\mathbb{P}[X_{2n} = k] = \frac{[z^n u^k]G(z, u)}{[z^n]G(z, 1)}, \quad \mathbb{P}[X_{2n+1} = k] = \frac{[z^n u^k]U(z, u)}{[z^n]U(z, 1)}.$$

The expected value and variance are equal to

$$\begin{aligned} \mathbb{E}(X_{2n}) &= \frac{[z^n]G_u(z, 1)}{[z^n]G(z, 1)}, \\ \mathbb{V}(X_{2n}) &= \frac{[z^n]G_{uu}(z, 1)}{[z^n]G(z, 1)} + \frac{[z^n]G_u(z, 1)}{[z^n]G(z, 1)} - \left(\frac{[z^n]G_{uu}(z, 1)}{[z^n]G(z, 1)} \right)^2, \end{aligned}$$

where $G_u(z, 1) := \frac{\partial}{\partial u} G(z, u) \Big|_{u=1}$, and $G_{uu}(z, 1) := \frac{\partial^2}{\partial u^2} G(z, u) \Big|_{u=1}$. Obviously, the same holds for X_{2n+1} with $G(z, u)$ replaced by $U(z, u)$.

Then, singularity analysis directly gives

Theorem 1.5.3. *The number of Dyck meanders of length n is equal to*

$$m_n = \begin{cases} \binom{2n}{n}, & \text{for } n = 2k, \\ \binom{2n+1}{n}, & \text{for } n = 2k + 1. \end{cases}$$

The expected value and the variance for the final altitude of meanders of length n are asymptotically equal to

$$\mathbb{E}(X_n) = \sqrt{\pi n} + \mathcal{O}(1), \quad \mathbb{V}(X_n) = (4 - \pi)n + \mathcal{O}(1).$$

Proof. Let us start with the asymptotic number of meanders. A direct computation gives

$$G(z, 1) = \frac{1}{\sqrt{1-4z}}, \quad U(z, 1) = \frac{1}{2z} \left(\frac{1}{\sqrt{1-4z}} - 1 \right).$$

Extracting the coefficient of z^n gives the result.

We perform the computations for $G(z, u)$, the ones for $U(z, u)$ are analogous. We get

$$G_u(z, 1) = \frac{1}{1-4z} - \frac{1}{\sqrt{1-4z}},$$

$$G_{uu}(z, 1) = \frac{2}{(1-4z)^{3/2}} - \frac{3}{1-4z} + \frac{1}{\sqrt{1-4z}}.$$

Applying singularity analysis to each of these terms directly gives the result. \square

It is noteworthy that the leading terms for $n \rightarrow \infty$ of the expected value and the variance do not depend on the parity of n . One can show that the limit distribution of the rescaled random variable $\frac{X_n}{\sqrt{n}}$ is a Rayleigh distribution with parameter $\sigma = \sqrt{2}$, see [19, Theorem 6].

1.6 PROPERTIES OF GENERAL DIRECTED LATTICE PATHS

In this section we present known results on directed lattice paths which generalize the previous results and which we build upon later in this thesis. Readers familiar with the exposition of Banderier and Flajolet [19] or related results may skip this section.

Their generating functions have been fully characterized in [19] by means of analytic combinatorics. The main results are summarized in the following Table 2 which generalizes Table 1 to arbitrary simple step sets.

	ending anywhere	ending at 0
unconstrained (on \mathbb{Z})	 <p>walk/path (\mathcal{W}) $W(z) = \frac{1}{1-zP(1)}$</p>	 <p>bridge (\mathcal{B}) $B(z) = z \sum_{i=1}^c \frac{u_i'(z)}{u_i(z)}$</p>
constrained (on \mathbb{Z}_+)	 <p>meander (\mathcal{M}) $M(z) = \frac{\prod_{i=1}^c (1-u_i(z))}{1-zP(1)}$</p>	 <p>excursion (\mathcal{E}) $E(z) = \frac{(-1)^{c-1}}{p^{-1}z} \prod_{i=1}^c u_i(z)$</p>

Table 2: The four types of paths: walks, bridges, meanders and excursions, and the corresponding generating functions for directed lattice paths [19, Fig. 1].

Definition 1.6.1 (p -periodic). A walk is called p -periodic or short periodic with period p if there exists a polynomial $H(u)$ and integers $b \in \mathbb{Z}$ and $p \in \mathbb{N}$, $p > 1$ such that $P(u) = u^b H(u^p)$. Otherwise it is called aperiodic.

Note that generating functions of aperiodic walks possess a unique singularity on the positive real axis [19].

Example 1.6.2 (Periodic lattice paths). The easiest example of periodic lattice paths is the one of Dyck paths. They are defined by the jump set $\mathcal{S} = \{-1, 1\}$ where each step has weight 1. The jump polynomial is $P(u) = u^{-1} + u$ and can therefore be rewritten into $P(u) = u^{-1}H(u^2)$ with $H(u) = 1 + u$. Thus, the period is 2.

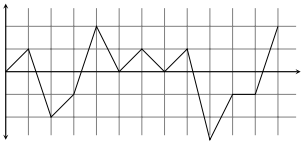
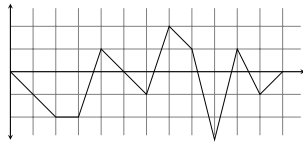
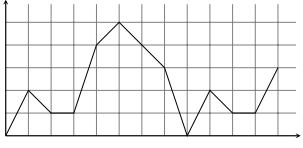
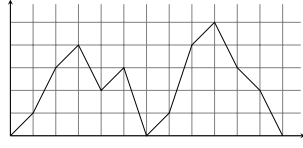
A more interesting example is given by the step set $\mathcal{S} = \{-2, 5\}$ which was introduced by Knuth¹¹ at the conference “Analysis of Algorithms 2014” (AofA 2014). In his “Flajolet lecture” he presented 5 problems with a strong flavor of analytic combinatorics (his slides are available online¹²). His problem #4 treated the mentioned lattice paths. Because of $P(u) = u^{-2}H(u^7)$ these are lattice paths of period $p = 7$. The problem is solved in Chapter 5, where the problems of periodic lattice paths are discussed and explained in more detail as well.

¹¹ Donald E. Knuth, 10.1.1938-

¹² <http://www-cs-faculty.stanford.edu/~uno/flaj2014.pdf>

The kernel plays a crucial role and is name-giving for the *kernel method*, which we have already encountered in the proof of Theorem 1.3.6. It is the key tool for characterizing this family of lattice paths. The interested reader is referred to [19, Chapter 2]. In the heart of this method lies the observation that the kernel equation is of degree $c + d$ in u , and therefore possesses generically $c + d$ roots. These correspond to branches of an algebraic curve given by the kernel equation. From the theory of algebraic curves and Newton-Puiseux series, for z near 0 one obtains c “small branches” $u_1(z), \dots, u_c(z)$ and d “large branches” $v_1(z), \dots, v_d(z)$. For being well-defined, we restrict ourselves to the complex plane slit along the negative real axis.

They are called “small branches” as they satisfy $\lim_{z \rightarrow 0} u_i(z) = 0$, whereas the “large branches” satisfy $\lim_{z \rightarrow 0} |v_i(z)| = \infty$. Banderier and Flajolet showed that the generating functions of bridges, excursions and meanders can be expressed in terms of the small branches and the jump polynomial, see Table 2.

The branch $u_1(z)$ is real and positive near 0 and called the *principal small branch*. It proves to be responsible for the asymptotic behavior of bridges, excursions, and meanders, compare [19, Theorems 3 and 4]. The branch $v_1(z)$ is conjugated to $u_1(z)$ and called the *principal large branch*.

Lemma 1.6.3 ([19, Lemma 1]). *Let $P(u)$ be the jump polynomial associated with the steps of a simple walk. Then, there exists a unique number τ , called the structural constant, such that $P'(\tau) = 0$, $\tau > 0$. The structural radius is defined by the quantity*

$$\rho := \frac{1}{P(\tau)}.$$

Under the aperiodicity condition, the principal small branch dominates the other branches:

$$\begin{aligned} |u_j(z)| &< u_1(|z|), & \text{for } z \leq \rho, j > 1, & \text{ and} \\ |u_1(z)| &< |v_1(z)|, & \text{for } z < \rho. \end{aligned}$$

Furthermore, we know that the principal branches $u_1(z)$ and $v_1(z)$ are analytic in the open interval $(0, \rho)$ for an aperiodic step set, and they satisfy the singular expansions

$$\begin{aligned} u_1(z) &= \tau - C \sqrt{1 - \frac{z}{\rho}} + \mathcal{O}\left(1 - \frac{z}{\rho}\right), \\ v_1(z) &= \tau + C \sqrt{1 - \frac{z}{\rho}} + \mathcal{O}\left(1 - \frac{z}{\rho}\right), \end{aligned} \tag{18}$$

for $z \rightarrow \rho^-$, where $C := \sqrt{2 \frac{P(\tau)}{P''(\tau)}}$. The previous result is a direct consequence of the implicit function theorem, see [19]. But one can get even more information with the help of its singular version [85, Lemma VII.3].

Theorem 1.6.4 (Singular Implicit Functions [85, Lemma VII.3]). *Let $F(z, w)$ be a bivariate function analytic at $(z, w) = (z_0, w_0)$. Assume the following conditions: $F(z_0, w_0) = 0$, $F_z(z_0, w_0) \neq 0$, $F_w(z_0, w_0) = 0$, and $F_{ww}(z_0, w_0) \neq 0$. Choose an arbitrary ray of angle θ emanating from z_0 . Then, there exists a neighborhood Ω of z_0 such that at every point z of Ω with $z \neq z_0$ and z not on the ray, the equation $F(z, y) = 0$ admits two analytic solutions $y_1(z)$ and $y_2(z)$ that satisfy for $z \rightarrow z_0$:*

$$y_1(z) = w_0 - \gamma \sqrt{1 - z/z_0} + \mathcal{O}(1 - z/z_0), \quad \gamma = \sqrt{\frac{2z_0 F_z(z_0, w_0)}{F_{ww}(z_0, w_0)}},$$

and similarly for y_2 whose expansion is obtained by changing $\sqrt{\cdot}$ to $-\sqrt{\cdot}$.

Proposition 1.6.5. *Let $u_1(z)$ and $v_1(z)$ be the principal small and large branches of the kernel equation $1 - zP(u) = 0$. Then, there exists a neighborhood Ω such that for $z \rightarrow \rho$ in $\Omega \setminus (\rho, \infty)$ they have a local representation of the kind*

$$a(z) + b(z) \sqrt{1 - z/\rho},$$

where $a(z), b(z)$ are analytic functions for every point $z \in \Omega \setminus (\rho, \infty)$, $z \neq z_0$. We have that $a(\rho) = \tau$, and $b(\rho) = -C$ for $u_1(z)$ or $b(\rho) = C$ for $v_1(z)$, respectively. The other branches $u_2(z), \dots, u_c(z)$ and $v_2(z), \dots, v_d(z)$ are analytic in a neighborhood of ρ .

Proof. The branches $u(z)$, which we use as a shorthand for $u_i(z)$ and $v_i(z)$, are implicitly defined by $\Phi(z, u(z)) = 0$, where $\Phi(z, u) = 1 - zP(u)$. We will apply the singular implicit function theorem, Theorem 1.6.4. Firstly, it is easy to check that $\Phi(\rho, \tau) = 0$, $\Phi_z(\rho, \tau) = -\rho^{-1} \neq 0$, $\Phi_u(\rho, \tau) = 0$, and $\Phi_{uu}(\rho, \tau) = -\rho P''(\tau) \neq 0$. Note that the last equation is not equal to 0 because $P(u)$ is a convex function for real values of u .

The two possible solutions $y_1(z)$ and $y_2(z)$ correspond to the principal small branch $u_1(z)$ and the principal large branch $v_1(z)$, respectively. Thus, we recovered the asymptotic expansion (18).

Finally, the analytic nature of $a(z)$ and $b(z)$ follows from the Weierstrass preparation theorem, see Theorem 2.5.3.

The analytic character of the other small branches, follows from the analytic version of the implicit function theorem, Theorem 2.5.2: consider $\tilde{\Phi}(z, u) := \frac{\Phi(z, u)}{(u - u_1(z))(u - v_1(z))}$. Solving this function for u gives the solutions of $\Phi(z, u) = 0$ not equal to $u_1(z)$ or $v_1(z)$. But $\tilde{\Phi}_u(\rho, \tau) \neq 0$ and therefore these are analytic in a neighborhood of z_0 . \square

The Banderier-Flajolet model [19] consists of only one step set \mathcal{S} and the corresponding jump polynomial $P(u) = p_{-c}u^{-c} + \dots + p_d u^d$. Here p_{-c} is the weight of the biggest jump of size $-c$ down and p_d is the weight for the biggest jump of size d up.

In [19, Theorem 1] they show that the bivariate generating function of paths with z marking size and u marking final altitude relative to a simple set of steps \mathcal{S} is given by

$$W(z, u) = \frac{1}{1 - zP(u)}, \quad (19)$$

and that the generating function of bridges is algebraic and given by

$$B(z) = z \sum_{j=1}^c \frac{u'_j(z)}{u_j(z)} = -z \sum_{\ell=1}^d \frac{v'_\ell(z)}{v_\ell(z)}. \quad (20)$$

Additionally, the generating function $W_k(z)$ for paths terminating at altitude k is, for $-\infty < k < c$,

$$W_k(z) = z \sum_{j=1}^c \frac{u'_j(z)}{u_j^{k+1}(z)}, \quad (21)$$

and for $-d < k < \infty$,

$$W_k(z) = -z \sum_{\ell=1}^d \frac{v'_\ell(z)}{v_\ell^{k+1}(z)}. \quad (22)$$

Note that we see in these results that the small and large branches are in some sense conjugate to each other. This is due to their defining equation $1 - zP(u_i(z)) = 1 - zP(v_\ell(z)) = 0$.

In [19, Theorem 2] Banderier and Flajolet treat meanders and excursions. Their generating functions satisfy

$$E(z) = \frac{(-1)^{c-1}}{p^{-c}z} \prod_{j=1}^c u_j(z) = \frac{(-1)^{d-1}}{p^d z} \prod_{\ell=1}^d \frac{1}{v_\ell(z)}, \quad (23)$$

$$F(z, u) = \frac{\prod_{j=1}^c (u - u_j(z))}{u^c (1 - zP(u))} = -\frac{1}{p^d z} \prod_{\ell=1}^d \frac{1}{(u - v_\ell(z))}. \quad (24)$$

The results are summarized in Table 2.

1.7 INTRODUCTION TO THE COMBINATORICS OF TREES

At the end of this chapter we want to introduce the second family of combinatorial objects which are the focus of this thesis: trees. They have already been mentioned in Figure 11 where we have seen a natural link between Łukasiewicz paths and trees. Let us now give a rigorous definition.

Definition 1.7.1 (Graph). *A graph G consists of a set of vertices or nodes $V(G)$ and a set of edges $E(G) \subseteq \{\{v_1, v_2\} : v_1, v_2 \in V(G)\}$, which are 2-element subsets of $V(G)$. If the pairs are ordered we call the graph directed, otherwise it is called undirected.*

The degree of a vertex $v \in V(G)$ is the number of edges in $E(G)$ containing v . In directed graphs we call the out-degree the number of edges of the kind (v, w) , and the in-degree the number of edges of the kind (w, v) , for $w \in E(G)$.

A path on a graph of length n is a sequence of vertices (v_0, v_1, \dots, v_n) where subsequent vertices v_i and v_{i+1} are connected by a common edge $(v_i, v_{i+1}) \in E(G)$.

A cycle is a path starting and ending at the same vertex and without repetitions of any vertex.

A graph is called acyclic if it does not contain any cycles.

A graph is connected if for any pair of nodes there exists a path connecting the two nodes.

A graph is rooted if one of its vertices is distinguished. This vertex is called the root.

Furthermore, we need to answer the question whether two given graphs are the same.

Definition 1.7.2. Two graphs G_1 and G_2 are isomorphic if there exists a bijection between the vertex sets of G_1 and G_2 , $f : V(G_1) \rightarrow V(G_2)$, such that two vertices v and w of G_1 are adjacent if and only if $f(v)$ and $f(w)$ are adjacent in G_2 . If $G_1 = G_2$ we call the bijection f an automorphism. The automorphism group of the graph G_1 is denoted by $\text{Aut}(G_1)$.

Definition 1.7.3 (Tree). A tree is a connected undirected acyclic graph. Vertices of degree 1 are called leaves or external nodes. All other vertices are called internal nodes.

Note that rooted trees can be interpreted as directed graphs. Every edge is directed away from the root, thus there is a path from the root to any leaf.

One of the focuses of this thesis are trees. Therefore, all following concepts and definitions are adapted to their nature.

Labeled and unlabeled trees

A tree can either be *labeled* or *unlabeled*. A labeled tree of size n consists of the set of vertices V , the set of edges E , and a permutation $\sigma \in S_n$ of size n , which we call a *labeling*. The permutation assigns to every vertex a label, which is a distinct number from $\{1, 2, \dots, n\}$. Two labeled graphs are considered to be equal if they have the same set of vertices, edges, and the same labeling.

On the contrary, in an unlabeled tree the vertices are not distinguishable. One obviously obtains an unlabeled tree from a labeled tree by removing all the labels. But this mapping is not bijective. Two labeled trees $\mathcal{T}_1, \mathcal{T}_2$ will give the same unlabeled tree if there exists a permutations $\tau \in S_n$ on the set of labels, such that applying this permutation on the labels of \mathcal{T}_1 gives \mathcal{T}_2 . In other words, unlabeled trees are labeled trees up to this isomorphism.

Plane and non-plane trees

Yet another isomorphism appears when one considers trees embedded in the plane. Informally, an *embedding* into the plane of a tree is a drawing where no two edges intersect, except at vertices. In particular, the order of the children is important.

Rooted trees are then called *plane* if every embedding is considered as a different tree. Otherwise they are called *non-plane*.

Let us state now some famous examples of trees.

- *Binary trees* are rooted plane trees with out-degrees 0 or 2. They are counted by the Catalan numbers $\frac{1}{n+1} \binom{2n}{n}$.
- A *Cayley tree* is a rooted labeled non-plane tree. It is a famous result that there are exactly n^{n-1} Cayley trees of size n .
- A *Pólya tree* is a rooted unlabeled non-plane tree. They are more complicated to count, and we will introduce the counting theory after the next subsection.

Counting labeled classes

In order to count labeled combinatorial classes we introduce a new class of generating functions. Ordinary generating functions from Definition 1.2.6 are the concept of choice for unlabeled classes, yet for labeled classes we use *exponential generating functions*.

Definition 1.7.4. The exponential generating function (EGF) of a sequence $(a_n)_{n \geq 0}$ is the formal power series

$$A(z) = \sum_{n \geq 0} a_n \frac{z^n}{n!}.$$

Similar to ordinary generating functions, the disjoint union and the Cartesian product (with correct relabeling!) translate into the addition and product of exponential generating functions. For the purpose of this thesis we will not need these concepts. The interested reader is referred to the thorough introduction by Flajolet and Sedgewick [85].

Counting unlabeled classes with symmetries - Pólya theory

We have already seen how to count unlabeled objects with ordinary generating functions if they do not possess too many symmetries. However, in the case of symmetries, like in the case of Pólya trees we need to understand the defining isomorphisms. These are in general the reason why unlabeled counting is more involved than labeled counting. This theory was founded by Pólya in [157]. Next, we want to give a brief introduction into this subject. This notion will be picked

up again in Chapter 7. In this subsection we follow mostly the lines of the thesis [130] by Kraus, which treats a large class of unlabeled combinatorial objects.

The theory relies on the concept of *cycle index sums*. One can think of them as refined versions of generating functions with an infinite set of random variables (s_1, s_2, \dots) .

Definition 1.7.5. Let M be a finite set of n elements and $\sigma \in S_M$ a permutation of the elements of M . The cycle type $ZT(\sigma)$ of σ is defined by

$$ZT(\sigma) = s_1^{\lambda_1(\sigma)} s_2^{\lambda_2(\sigma)} \cdots s_n^{\lambda_n(\sigma)},$$

where $\lambda_i(\sigma)$ is the number of cycles of length i in σ . As a shorthand we define $\sigma_i = \lambda_i(\sigma)$, and call the sequence $(\sigma_1, \sigma_2, \dots, \sigma_n)$ the type of σ .

Let G be a subgroup of the symmetric group S_n . Then, the cycle index is

$$Z(G; s_1, s_2, \dots, s_k) = \frac{1}{|G|} \sum_{\sigma \in G} ZT(\sigma) = \frac{1}{|G|} \sum_{\sigma \in G} s_1^{\sigma_1} s_2^{\sigma_2} \cdots s_k^{\sigma_k}.$$

Example 1.7.6. Let $|M| = n$, then we have

- for $G = \{id\}$:

$$Z(G) = s_1^n;$$

- for $G = \{S_n\}$:

$$Z(G) = \frac{1}{n!} \sum_{i_1+2i_2+\dots+ni_n=n} \frac{n!}{i_1!i_2!\cdots i_n! \cdot 1^{i_1}2^{i_2}\cdots n^{i_n}} s_1^{i_1} s_2^{i_2} \cdots s_n^{i_n}.$$

Cycle indices help us to count unlabeled objects from a family \mathcal{A} . For every structure $\alpha \in \mathcal{A}$ we define the permutation group S_α as the subgroup of permutations on the set of atoms of α which do not change the object. This is the set of permutations representing the symmetries of α , which we call *allowed permutations* on α .

Definition 1.7.7. Let \mathcal{A} be a combinatorial class. The cycle index sum $Z_{\mathcal{A}}(\mathbf{s}_1)$ of the class \mathcal{A} is defined by

$$Z_{\mathcal{A}}(\mathbf{s}_1) = \sum_{\alpha \in \mathcal{A}} Z(S_\alpha; s_1, \dots, s_{|\alpha|}),$$

where S_α is the set of allowed permutations of α and \mathbf{s}_1 denotes the infinite set of variables (s_1, s_2, \dots) .

This series keeps track of all symmetries of the objects of \mathcal{A} . Note that if we substitute $s_i = z^i$ we obtain the ordinary generating function of the class \mathcal{A} . This new machinery is also amenable to the symbolic language, however one needs to deal with this cycle index sum in all constructions.

A good example for this phenomenon is the substitution $\mathcal{B} \circ \mathcal{A}$. This construction does not translate into $B(A(z))$ on the level of generating functions, as by replacing every atom of a structure from \mathcal{B} with a new structure \mathcal{A} , we add and destroy symmetries.

Let us look in more detail into this problem: Consider the k elements v_1, \dots, v_k of a cycle of a permutation of the atoms of an object $\beta \in \mathcal{B}$. We want to substitute each of the elements v_i by an element $\alpha_i \in \mathcal{A}$. If any of these substituted structures were different from each other, the symmetry would be destroyed. Thus, we need to substitute k identical copies of $\alpha \in \mathcal{A}$ into the elements v_1, \dots, v_k to maintain the symmetry. This results in a cycle of length k with identical copies of α for every $\alpha \in \mathcal{A}$.

In general, this problem is solved by the Pólya-Redfield Theorem.

Let D and R be finite sets and $M = R^D$. Furthermore, let G be a subgroup of S_D . A permutation $\sigma \in G$ induces a permutation

$$(\tilde{\sigma}(f))(x) := f(\sigma(x)), \quad f \in M, x \in D,$$

on S_M . The thereby constructed set \tilde{G} is obviously a subgroup of S_M and isomorphic to G .

Two functions $f, g \in M$ are called *equivalent* ($f \sim g$) if there exists a permutation $\sigma \in G$ such that $\tilde{\sigma}(f) = g$.

Furthermore, every element $r \in R$ is assigned a weight $w(r)$. This gives a mapping $w : R \rightarrow W$ from R into a set of weights W . Then, we define the weight of a function $f \in M$ by

$$w(f) := \prod_{x \in D} w(f(x)).$$

We have $w(f) = w(g)$ for $f \sim g$. Therefore, the weight $w(c)$ is defined for every equivalence class $c \in M / \sim$.

Theorem 1.7.8 (Pólya-Redfield, [37]). *Let R, D be finite sets, G be a subgroup of S_D and $M = R^D$. Then,*

$$\sum_{c \in M / \sim} w(c) = Z \left(G; \sum_{r \in R} w(r), \sum_{r \in R} w(r)^2, \dots, \sum_{r \in R} w(r)^{|D|} \right).$$

This theorem can be extended formally to the case of countable sets D, R . We do not go into the details at this point. Let us just sketch the idea: Consider a k -tuple $(\alpha_1, \dots, \alpha_k)$ of elements $\alpha_i \in \mathcal{A}$. Its size is given by $|(\alpha_1, \dots, \alpha_k)| = \sum_{i=1}^k |\alpha_i|$. Then, set $D = \{1, \dots, k\}$, $R = \mathcal{A}$ and $w(\alpha) = z^{|\alpha|}$ to apply the previous theorem. This gives for the substitution

$$Z_{\mathcal{B} \circ \mathcal{A}}(\mathbf{s}_1) = Z_{\mathcal{B}}(Z_{\mathcal{A}}(\mathbf{s}_1), Z_{\mathcal{A}}(\mathbf{s}_2), \dots),$$

where $Z_{\mathcal{B}}$ is the cycle index sum of the class \mathcal{B} , $Z_{\mathcal{A}}$ the cycle index sum of the class \mathcal{A} , and \mathbf{s}_k denotes the vector $(s_k, s_{2k}, s_{3k}, \dots)$ for $k \geq 1$.

Finally, we get that the ordinary generating function $C(z)$ of the class $\mathcal{B} \circ \mathcal{A}$ is given by

$$C(z) = Z_{\mathcal{B}}(A(z), A(z^2), \dots).$$

Additionally, with a little bit more work (see e.g. [130]) one gets for cycle index sum $Z_{\mathcal{B}}(\mathbf{s}_1)$ of a multiset of objects of \mathcal{A} , i.e. $\mathcal{B} = \text{MSET}(\mathcal{A})$

$$Z_{\mathcal{B}}(\mathbf{s}_1) = \exp\left(\sum_{i \geq 1} \frac{Z_{\mathcal{A}}(\mathbf{s}_i)}{i}\right),$$

and for the generating function

$$B(z) = \exp\left(\sum_{i \geq 1} \frac{A(z^i)}{i}\right).$$

Finally, this gives us the tool to model the generating function $T(z) = \sum_{n \geq 0} t_n z^n$ of Pólya trees. Such a tree consists of a root and a multiset of Pólya trees. Hence,

$$T(z) = z \exp\left(\sum_{i \geq 1} \frac{T(z^i)}{i}\right). \tag{25}$$

By differentiating both sides with respect to z , one can derive a recurrence relation of t_n (see [149, Chapter 29] and [150]). The first few terms of $T(z)$ are then

$$T(z) = z + z^2 + 2z^3 + 4z^4 + 9z^5 + 20z^6 + 48z^7 + 115z^8 + \dots, \tag{26}$$

compare OEIS [A000081](#). By differentiating both sides of (25) with respect to z , one can derive a recurrence relation of t_n (see [149, Chapter 29] and [150]), which is

$$t_n = \frac{1}{n-1} \sum_{i=1}^{n-1} t_{n-i} \sum_{m|i} m t_m, \quad \text{for } n > 1, \text{ and } t_1 = 1.$$

Pólya [157] showed that the radius of convergence ρ of $T(z)$ satisfies $0 < \rho < 1$ and that ρ is the only singularity on the circle of convergence $|z| = \rho$. Subsequently, Otter [150] proved that $T(\rho) = 1$ as well as the asymptotic expansion

$$T(z) = 1 - b(\rho - z)^{1/2} + c(\rho - z) + \mathcal{O}\left((\rho - z)^{3/2}\right), \tag{27}$$

locally around $z = \rho$. By transfer theorems he derived

$$t_n = \frac{b\sqrt{\rho}}{2\sqrt{\pi}} \frac{\rho^{-n}}{\sqrt{n^3}} \left(1 + \mathcal{O}\left(\frac{1}{n}\right)\right),$$

where $\rho \approx 0.3383219$, $b \approx 2.68112$ and $c = b^2/3 \approx 2.39614$.

This ends our discussion on unlabeled trees. More details will be given in Chapter 7.

2

METHODS

In this chapter, we introduce methods that will be used throughout this thesis.

We start with some results on probability distributions and continue with their appearances in the context of limit laws. These results are strongly connected with bivariate generating functions and the concept of marking in combinatorial constructions, see Section 1.4.

2.1 PROBABILITY DISTRIBUTIONS

Probability distributions can be decomposed into two big classes: discrete and continuous ones. Discrete probability distributions are characterized by a probability mass function (PMF) of at most countable support. This gives a non-continuous cumulative distribution function (CDF). Yet, continuous probability distributions are characterized by a continuous cumulative distribution function. If their mass function exists we call it a probability density function (PDF).

In this thesis a priori all arising probability distributions are discrete, as they are defined on finite sets. However, as the size n of the objects grows, these finite distributions usually approach a continuous limit.

We just briefly sketch the most important ones which will appear in this thesis. For more details we refer to [85, 179].

Discrete probability distributions

In our case the support of discrete probability distributions will (in most cases) be $\mathbb{N} = \{0, 1, 2, \dots\}$. The results of this subsection are summarized in Table 3.

Probably the most fundamental discrete probability distribution is the *Bernoulli distribution* of parameter p with $0 \leq p \leq 1$. It is the distribution of a random variable X which takes the value 1 with probability p , and the value 0 with probability $1 - p$. We denote this case by $X \sim \mathcal{B}(p)$. One directly gets $\mathbb{E}(X) = p$ and $\mathbb{V}(X) = p(1 - p)$.

From the Bernoulli distribution one directly derives the *binomial distribution* of parameters n, p . It represents the number of successes in n independent Bernoulli trials. A random variable X obeying this distribution is denoted by $X \sim \mathcal{B}(n, p)$. Its PMF is given by

$$\mathbb{P}[X = k] = \binom{n}{k} p^k (1 - p)^{n-k},$$

	Bernoulli B(p)	Binomial B(n, p)	Geometric Geom(p)	Neg. binomial NB(m, p)
				
Support	$k \in \{0, 1\}$	$k \in \{0, 1, \dots, n\}$	$k \in \{0, 1, \dots\}$	$k \in \{0, 1, \dots\}$
PMF	$\begin{cases} p, & k = 1 \\ 1 - p, & k = 0 \end{cases}$	$\binom{n}{k} p^k (1 - p)^{n-k}$	$(1 - p)^k p$	$\binom{m+k-1}{k} (1 - p)^k p^m$
Mean	p	np	$\frac{1-p}{p}$	$\frac{m(1-p)}{p}$
Variance	$p(1 - p)$	$np(1 - p)$	$\frac{1-p}{p^2}$	$\frac{m(1-p)}{p^2}$

Table 3: A comparison of the encountered discrete distributions: Bernoulli, binomial, geometric and negative binomial distribution.

and we have $\mathbb{E}(X) = np$ and $\mathbb{V}(X) = np(1 - p)$.

Another distribution that is derived from the Bernoulli distribution is the *geometric distribution* of parameter p . It records the number of failures till the first success in a potentially arbitrarily long sequence of Bernoulli trials. We write $X \sim \text{Geom}(p)$. The PMF is equal to

$$\mathbb{P}[X = k] = (1 - p)^k p,$$

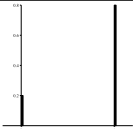
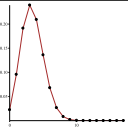
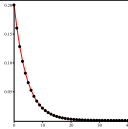
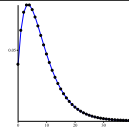
and we have $\mathbb{E}(X) = \frac{1-p}{p}$ and $\mathbb{V}(X) = \frac{1-p}{p^2}$.

The last discrete probability distribution we want to mention is the *negative binomial distribution* of parameters m, p , which is also related to the Bernoulli distribution. It corresponds to the number of failures before m successes are encountered. We write $X \sim \text{NB}(m, p)$, and the PMF is equal to

$$\mathbb{P}[X = k] = \binom{m+k-1}{k} (1 - p)^k p^m.$$

In this case, we have $\mathbb{E}(X) = \frac{m(1-p)}{p}$ and $\mathbb{V}(X) = \frac{m(1-p)}{p^2}$.

Continuous probability distributions

The results of this subsection are summarized in Table 4.

The probably most famous and most often appearing continuous probability distribution is the *normal distribution* or *Gaussian distribution*. It is characterized by its mean μ and its standard deviation σ , and we write $X \sim \mathcal{N}(\mu, \sigma)$. Its density function is equal to

$$f_{\mathcal{N}}(x) = \frac{1}{\sqrt{2\pi\sigma^2}} e^{-\frac{(x-\mu)^2}{2\sigma^2}}.$$

We call it the *standard normal distribution* if $\mu = 0$ and $\sigma = 1$.

	Normal $\mathcal{N}(\mu, \sigma)$	Half-normal $\mathcal{H}(\sigma)$	Rayleigh $\mathcal{R}(\sigma)$
			
Support	$x \in \mathbb{R}$	$x \in \mathbb{R}_{\geq 0}$	$x \in \mathbb{R}_{\geq 0}$
PDF	$\frac{1}{\sqrt{2\pi\sigma^2}} e^{-\frac{(x-\mu)^2}{2\sigma^2}}$	$\sqrt{\frac{2}{\pi\sigma^2}} e^{-\frac{x^2}{2\sigma^2}}$	$\frac{x}{\sigma^2} e^{-\frac{x^2}{2\sigma^2}}$
Mean	μ	$\sigma\sqrt{\frac{2}{\pi}}$	$\sigma\sqrt{\frac{\pi}{2}}$
Variance	σ^2	$\sigma^2\left(1 - \frac{2}{\pi}\right)$	$\sigma^2\left(2 - \frac{\pi}{2}\right)$

Table 4: A comparison of the encountered continuous distributions: normal, half-normal, and Rayleigh distribution.

As in the discrete case we are able to derive several distributions from this fundamental one. Firstly, the *half-normal distribution* of parameter σ is generated by the absolute value $|X|$ of a normally distributed random variable X with mean $\mu = 0$. We denote it by $X \sim \mathcal{H}(\sigma)$, and its density function is equal to

$$f_{\mathcal{H}}(x) = \sqrt{\frac{2}{\pi\sigma^2}} e^{-\frac{x^2}{2\sigma^2}}.$$

One directly gets that $\mathbb{E}(X) = \sigma\sqrt{\frac{2}{\pi}}$ and $\mathbb{V}(X) = \sigma^2\left(1 - \frac{2}{\pi}\right)$.

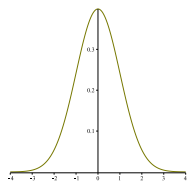
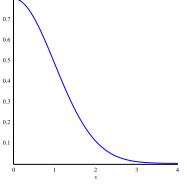
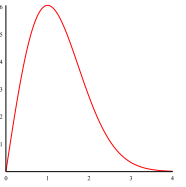
Secondly, the *Rayleigh distribution* of parameter σ is generated by the Euclidean norm of two independent normally distributed random variables with means $\mu = 0$. We write $X \sim \mathcal{R}(\sigma)$. In formulae we have $X = \sqrt{Y_1^2 + Y_2^2}$ with $Y_1, Y_2 \sim \mathcal{N}(0, \sigma^2)$ independent. Its density function is the rescaled derivative of the one of a normal distribution and is given by

$$f_{\mathcal{R}}(x) = \frac{x}{\sigma^2} e^{-\frac{x^2}{2\sigma^2}}.$$

Then, we have $\mathbb{E}(X) = \sigma\sqrt{\frac{\pi}{2}}$ and $\mathbb{V}(X) = \sigma^2\left(2 - \frac{\pi}{2}\right)$.

2.2 LIMIT LAWS

The theory of limit laws connects the combinatorial and the probabilistic point of view. A comprehensive introduction is found in [85, Chapter IX]. We want to give here a brief introduction into this subject drawing mostly from this source.

In the theory of analytic and enumerative combinatorics we always start with a combinatorial class \mathcal{A} . We are also often interested in an

integer valued combinatorial parameter χ . First of all we naturally get a family of probabilistic models: for each n the uniform distribution over \mathcal{A}_n assigns to any $\alpha \in \mathcal{A}_n$ the probability

$$\mathbb{P}[\alpha] = \frac{1}{a_n}, \quad \text{with} \quad a_n = |\mathcal{A}_n|.$$

This model induces a probability distribution on the parameter χ . In particular we obtain a family of random variables X_n by restricting χ to \mathcal{A}_n . Under the uniform distribution over \mathcal{A}_n we get

$$\mathbb{P}[X_n = k] = \frac{|\{\alpha \in \mathcal{A}_n \mid \chi(\alpha) = k\}|}{a_n}.$$

The notion of a *limit law* is motivated by the observation that an increasing n often leads to a common profile in the distribution of X_n .

For our purposes the notion of convergence in distribution or weak convergence is important. Let us briefly recall it now.

Definition 2.2.1 (Weak convergence, [85, Chapter C.5]). *Let F_n be a family of distribution functions. The F_n are said to converge weakly to a distribution function F if*

$$\lim_{n \rightarrow \infty} F_n(x) = F(x),$$

holds pointwise at every continuity point x of F . Let X_n and X be the random variables associated to F_n and F , respectively. Then, we say that X_n converges in distribution or converges in law to X .

Most importantly for our work is the connection of characteristic functions and random variables.

Theorem 2.2.2 (Continuity theorem for characteristic functions, [40]). *Let Y and Y_n be random variables with characteristic functions ϕ and ϕ_n , respectively. A necessary and sufficient condition for weak convergence of Y_n to Y is that $\phi_n(t) \rightarrow \phi(t)$ for each $t \in \mathbb{R}$.*

Returning to our initial motivation, we shall say that a *limit law* exists for a parameter if there is convergence of the corresponding family of cumulative distribution functions. We distinguish between two types of convergence of the a priori discrete distribution of a combinatorial parameter:

- discrete \rightarrow discrete
- discrete \rightarrow continuous

At this point we need to remark that the limit might only exist after suitable standardization. In the discrete-to-discrete case this is in general not necessary (though cases are known, but not encountered in this thesis). However, in the discrete-to-continuous case the random

variable needs to be centered at its mean and scaled by its standard deviation such as

$$\frac{X_n - \mu_n}{\sigma_n}, \quad \text{with} \quad \mu_n = \mathbb{E}(X_n), \quad \sigma_n^2 = \mathbb{V}(X_n),$$

in order to allow existence of a (weak) limit. Note that also different rescalings are possible. Yet, in many cases this is the most useful one.

Such results (whether centered or not) are also often called *central limit laws* or *global limit laws*. They give a qualitative feeling for their behavior. One often wishes to get a deeper understanding. This is answered by a *local limit law*. This, when available, quantifies individual probabilities (rather than the cumulative distribution functions). In the discrete-to-discrete case these two notions are equivalent. In the discrete-to-continuous setting, the local limits are expressed in terms of fixed probability densities. These results are in general technically more demanding, as stronger analytic properties are necessary.

Let us make this informal statement explicit in the case of a Gaussian law. Its generalization to different distributions is straightforward by replacing the density function $e^{-x^2/2}$ with the respective one. One of the first sources of this notion is found in Bender's groundbreaking work [36].

Definition 2.2.3 (Local limit law). *A sequence of discrete probability distributions $p_{n,k} = \mathbb{P}[X_n = k]$, with mean μ_n and standard deviation σ_n is said to obey a local limit law of Gaussian type if, for a sequence $\varepsilon_n \rightarrow 0$,*

$$\sup_{x \in \mathbb{R}} \left| \sigma_n p_{n, \lfloor \mu_n + x\sigma_n \rfloor} - \frac{1}{\sqrt{2\pi}} e^{-x^2/2} \right| \leq \varepsilon_n.$$

The local limit law is said to hold with speed ε_n .

In the next section we will see how generating functions and limit laws are connected, and we will present several deep results linking analytic and algebraic properties with underlying probability distributions.

2.3 SCHEMES FOR GENERATING FUNCTIONS

Generating functions have proved very useful in the analysis of combinatorial questions. The approach builds on general principles of the correspondence between combinatorial constructions and functional operations. The symbolic method [85] provides a direct translation of the structural description of a class into an equation of generating functions.

Especially bivariate generating functions like $F(z, u) = \sum f_{nk} z^n u^k$ have been extensively investigated. Combining them with the idea of marking, which was introduced in Section 1.4, they provide access to

the underlying probability distributions of certain parameters. Recall that the definition of a family of random variables $(X_n)_{n \geq 0}$ by

$$\mathbb{P}[X_n = k] := \frac{[z^n u^k]F(z, u)}{[z^n]F(z, 1)},$$

links the symbolic world with the probabilistic one. The obvious question in this context concerns the nature of the random variables X_n and the one of their (if existent) limit. A *scheme* answers this question for certain classes. However, the answer is given without computing the actual random variable, but by analyzing certain properties of the bivariate generating function. These could be algebraic (decomposition, positivity of coefficients, ...), analytic (radius of convergence, distribution of singularities, ...), or probabilistic (existence of certain moments, variability conditions, ...) properties.

Especially for the case of a Gaussian limit distribution there are many different schemes known: Bender's central limit theorems [36], Hwang's quasi-powers theorem [113], the supercritical composition scheme [85, Proposition IX.6], the algebraic singularity scheme [85, Theorem IX.12], an implicit function scheme for algebraic singularities [66, Theorem 2.23], or the limit law version of the Drmota-Lalley-Woods theorem [17, Theorem 8]. But such schemes also exist for other distributions, like e.g., the Airy distribution [20]. In general, it was shown in [15] and [17, Theorem 10] that even in simple examples "any limit law", in the sense that the limit curve can be arbitrarily close to any càdlàg multi-valued curve in $[0, 1]^2$, is possible.

In this section we introduce the most important schemes for our purposes. There are many ways to group different schemes. One of the most obvious one is the distinction between discrete and continuous schemes. Discrete schemes are schemes leading to a discrete limit distribution, whereas continuous ones give a continuous limit distribution.

A finer distinction can be made with respect to their resulting limit laws, as e.g. geometric schemes, normal schemes, Rayleigh schemes, half-normal schemes, etc.

Yet the most practical way for our purposes is to distinguish them by their nature. In the next subsections we introduce a pointwise convergence scheme, a large powers scheme, compositions schemes, square-root schemes, and a moment scheme.

Pointwise convergence scheme

The following scheme is tuned to probability generating functions, i.e. $P(1) = 1$. It gives sufficient conditions for a sequence of probability generating functions to possess a discrete limit distribution.

Theorem 2.3.1 (Continuity Theorem, [85, Theorem IX.1]). *Let Ω be an arbitrary set contained in the unit disc and having at least one accumula-*

tion point in the interior of the disc. Assume that the probability generating functions $p_n(u) = \sum_{k \geq 0} p_{n,k} u^k$ and $q(u) = \sum_{k \geq 0} q_k u^k$ are such that there is convergence,

$$\lim_{n \rightarrow \infty} p_n(u) = q(u),$$

pointwise for each $u \in \Omega$. Then a discrete limit law holds in the sense that for each k

$$\lim_{n \rightarrow \infty} p_{n,k} = q_k, \quad \text{and} \quad \lim_{n \rightarrow \infty} \sum_{j \leq k} p_{n,j} = \sum_{j \leq k} q_j.$$

Large powers scheme

The following scheme is probably the most applied one. Many of the subsequent schemes are generalizations of it. Essentially, it is an application of the Central Limit Theorem from probability theory.

Theorem 2.3.2 (Quasi-powers Theorem, [85, Theorem IX.8] and [113]). *Let the X_n be non-negative discrete random variables (supported by $\mathbb{Z}_{\geq 0}$), with probability generating functions $p_n(u)$. Assume that, uniformly in a fixed complex neighborhood of $u = 1$, for sequences $\beta_n, \kappa_n \rightarrow \infty$, there holds*

$$p_n(u) = A(u) \cdot B(u)^{\beta_n} \left(1 + \mathcal{O} \left(\frac{1}{\kappa_n} \right) \right), \tag{28}$$

where $A(u), B(u)$ are analytic at $u = 1$ and $A(1) = B(1) = 1$. Assume finally that $B(u)$ satisfies the so called “variability condition”,

$$B''(1) + B'(1) - B'(1)^2 \neq 0. \tag{29}$$

Under these conditions, the mean and the variance of X_n satisfy

$$\begin{aligned} \mathbb{E}(X_n) &= \beta_n B'(1) + A'(1) + \mathcal{O} \left(\kappa_n^{-1} \right), \\ \mathbb{V}(X_n) &= \beta_n (B''(1) + B'(1) - B'(1)^2) \\ &\quad + (A''(1) + A'(1) - A'(1)^2) + \mathcal{O} \left(\kappa_n^{-1} \right). \end{aligned}$$

The distribution of X_n is, after standardization, asymptotically Gaussian, and the speed of convergence to the Gaussian limit is $\mathcal{O}(\kappa_n^{-1} + \beta_n^{-1/2})$:

$$\mathbb{P} \left[\frac{X_n - \mathbb{E}(X_n)}{\sqrt{\mathbb{V}(X_n)}} \leq x \right] = \frac{1}{\sqrt{2\pi}} \int_{-\infty}^x e^{-w^2/2} dw + \mathcal{O} \left(\frac{1}{\kappa_n} + \frac{1}{\sqrt{\beta_n}} \right).$$

Composition schemes

For composition schemes we follow the terminology of [85, Chapter VI.9]. A composition scheme is of the kind

$$g(uh(z)),$$

where $g(z)$ and $h(z)$ are functions analytic at the origin that have non-negative coefficients and $g(0) = 0$. Let ρ_g be the radius of convergence of $g(z)$, and ρ_h be the one of $h(z)$. We also assume that they are Δ -continuable and that they are admissible to singularity analysis. Then we distinguish between

- *supercritical composition schemes*, if $h(\rho_h) > \rho_g$,
- *critical composition schemes*, if $h(\rho_h) = \rho_g$,
- *subcritical composition schemes*, if $h(\rho_h) < \rho_g$.

In the supercritical cases we will need the following two theorems. For a function $f(z)$ we denote its radius of convergence by ρ_f .

Theorem 2.3.3 (Supercritical compositions, [85, Proposition IX.6]). *Consider the bivariate composition scheme $F(z, u) = g(uh(z))$. Assume that $g(z)$ and $h(z)$ satisfy the supercriticality condition $h(\rho_h) > \rho_g$, that g is analytic in $|z| < R$ for some $R > \rho_g$, with a unique dominant singularity at ρ_g , which is a simple pole, that the same holds for h with ρ_h , and that h is aperiodic. Then the number χ of \mathcal{H} -components in a random \mathcal{F}_n -structure, corresponding to the probability distribution $\mathbb{P}_n[\chi = k] = [u^k z^n]F(z, u) / [z^n]F(z, 1)$, has a mean and variance that are asymptotically proportional to n ; after standardization, the parameter χ tends to a limiting Gaussian distribution, with speed of convergence $\mathcal{O}(1/\sqrt{n})$.*

More details are found in the following proposition, which is a direct consequence of the previous theorem.

Proposition 2.3.4 (Supercritical sequences, [85, Proposition IX.7]). *Consider a sequence scheme $\mathcal{F} = \text{SEQ}(u\mathcal{H})$ that is supercritical, i.e., the value of h at its dominant positive singularity satisfies $h(\rho_h) > 1$. Assuming h to be aperiodic and $h(0) = 0$, the number X_n of \mathcal{H} -components in a random \mathcal{F}_n -structure of large size n is, after standardization, asymptotically Gaussian with¹*

$$\mathbb{E}(X_n) \sim \frac{n}{\rho h'(\rho)}, \quad \mathbb{V}(X_n) \sim n \frac{\rho h''(\rho) + h'(\rho) - \rho h'(\rho)^2}{\rho^2 h'(\rho)^3},$$

where ρ is the positive root of $h(\rho) = 1$. The number $X_n^{(m)}$ of components of some fixed size m is asymptotically Gaussian with mean $\sim \theta_m n$, where $\theta_m = h_m \rho^m / (\rho h'(\rho))$.

But these last results also hold if one allows a small perturbation. They will prove useful in the Chapters 3 and 6. The following Theorem is a variant of Theorem 2.3.3.

¹ The formula for the asymptotics of $\mathbb{V}(X_n)$ in [85, Proposition IX.7] contains some typos and misses the ρ -factors in the numerator and one in the denominator.

Proposition 2.3.5 (Perturbed supercritical composition). *Consider the bivariate composition scheme $F(z, u) = q(z)g(uh(z))$. Assume that $g(z)$ and $h(z)$ satisfy the supercriticality condition $h(\rho_h) > \rho_g$, that g is analytic in $|z| < R$ for some $R > \rho_g$, with a unique dominant singularity at ρ_g , which is a simple pole, and that h is aperiodic. Furthermore, let $q(z)$ be analytic for $|z| < \rho_h$. Then the number χ of \mathcal{H} -components in a random \mathcal{F}_n -structure, corresponding to the probability distribution $\mathbb{P}_n[\chi = k] = [u^k z^n]F(z, u) / [z^n]F(z, 1)$, has a mean and variance that are asymptotically proportional to n ; after standardization, the parameter χ satisfies a limiting Gaussian distribution, with speed of convergence $\mathcal{O}(1/\sqrt{n})$.*

Proof (Sketch). The proof of [85, Proposition IX.6] needs to be changed only slightly. As $q(z)$ is analytic at the dominant singularity, it contributes only a constant factor. Applying Hwang’s Quasi-powers theorem [85, Theorem IX.8] it contributes only to the function $C(u)$ which is used to define $A(u) = C(u)/C(1)$. Thus, it does not influence the result and yields the same as if $F(z, u) = g(uh(z))$ would have been analyzed. \square

A simple (and useful) application of this result is in the context of sequences. The following result is a variant of Proposition 2.3.4.

Proposition 2.3.6 (Perturbed supercritical sequences). *Consider a sequence scheme $\mathcal{F} = \mathcal{Q} \times \text{SEQ}(u\mathcal{H})$ that is supercritical, i.e., the value of h at its dominant positive singularity satisfies $h(\rho_h) > 1$. Furthermore, assume $q(z)$ to be analytic for $|z| < R$ for some $R > 1$. Assuming h to be aperiodic and $h(0) = 0$, the number X_n of \mathcal{H} -components in a random \mathcal{F}_n -structure of large size n is, after standardization, asymptotically Gaussian with*

$$\mathbb{E}(X_n) \sim \frac{n}{\rho h'(\rho)}, \quad \mathbb{V}(X_n) \sim n \frac{\rho h''(\rho) + h'(\rho) - \rho h'(\rho)^2}{\rho^2 h'(\rho)^3},$$

where ρ is the positive root of $h(\rho) = 1$. The number $X_n^{(m)}$ of components of some fixed size m is asymptotically Gaussian with mean $\sim \theta_m n$, where $\theta_m = h_m \rho^m / (\rho h'(\rho))$.

Proof. The proof follows exactly the same lines as [85, Proposition IX.7]. We state it for completeness.

The first part is a direct consequence of Proposition 2.3.5 with $g(z) = (1 - z)^{-1}$ and ρ_g replaced by 1. The second part results from the bivariate generating function

$$F(z, u) = \frac{q(z)}{1 - (u - 1)h_m z^m - h(z)},$$

and from the fact that u close to 1 induces a smooth perturbation of the pole of $F(z, 1)$ at ρ , corresponding to $u = 1$. \square

The following analytic scheme in general does not belong to the case of a composition scheme, but it vastly generalizes the supercritical compositions scheme.

Theorem 2.3.7 (Meromorphic scheme, [85, Theorem IX.9]). *Let $F(z, u)$ be a function that is bivariate analytic at $(z, u) = (0, 0)$ and has non-negative coefficients. Assume that $F(z, 1)$ is meromorphic in $|z| \leq r$ with only a simple pole at $z = \rho$ for some positive $\rho < r$. Assume the following conditions:*

1. *Meromorphic perturbation: there exists $\varepsilon > 0$ and $r > \rho$ such that in the domain $\mathcal{D} = \{|z| \leq r\} \times \{|u - 1| < \varepsilon\}$, the function $F(z, u)$ admits the representation*

$$F(z, u) = \frac{B(z, u)}{C(z, u)},$$

where $B(z, u)$ and $C(z, u)$ are analytic for $(z, u) \in \mathcal{D}$ with $B(\rho, 1) \neq 0$. (Thus ρ is a simple zero of $C(z, 1)$.)

2. *Non-degeneracy: one has $\partial_z C(\rho, 1) \cdot \partial_u C(\rho, 1) \neq 0$ ensuring existence of a non-constant $\rho(u)$ analytic at $u = 1$, and such that $C(\rho(u), u) = 0$ and $\rho(1) = \rho$.*
3. *Variability: one has*

$$r''(1) + r'(1) - r'(1)^2 \neq 0, \quad \text{with } r(u) = \frac{\rho(1)}{\rho(u)}.$$

Then, the random variable X_n with probability generating function

$$p_n(u) = \frac{[z^n]F(z, u)}{[z^n]F(z, 1)},$$

after standardization, converges in distribution to a Gaussian variable, with speed of convergence $\mathcal{O}(n^{-1/2})$. The mean and the variance of X_n are asymptotically given by

$$\begin{aligned} \mu_n &= r'(1)n + \mathcal{O}(1), \\ \sigma_n^2 &= (r''(1) + r'(1) - r'(1)^2)n + \mathcal{O}(1). \end{aligned}$$

Square-root schemes

In the critical cases we will need two theorems of a different type. They are described by a square root singularity. In particular, they are of the kind

$$g(z, u) + h(z, u) \sqrt{1 - \frac{z}{\rho(u)}},$$

where $g(z, u)$, $h(z, u)$, and $\rho(u)$ are analytic functions in a certain domain. More details are given below.

The first one is the Rayleigh distribution scheme of Drmota and Soria [70, Theorem 1]. The second one is the half-normal distribution scheme which is presented in Chapter 3.

Both of them require some technical conditions, which are summarized in the following hypothesis [H’].

Hypothesis [H’]. Let $c(z, u) = \sum_{n,k} c_{nk} z^n u^k$ be a power series in two variables with non-negative coefficients $c_{nk} \geq 0$ such that $c(z, 1)$ has a radius of convergence of $\rho > 0$.

We suppose that $1/c(z, u)$ has the local representation

$$\frac{1}{c(z, u)} = g(z, u) + h(z, u) \sqrt{1 - \frac{z}{\rho}}, \tag{30}$$

for $|u - 1| < \varepsilon$ and $|z - \rho| < \varepsilon$, $\arg(z - \rho) \neq 0$, where $\varepsilon > 0$ is some fixed real number, and $g(z, u)$ and $h(z, u)$ are analytic functions. Furthermore, we have $g(\rho, 1) = 0$.

In addition, $z = \rho$ is the only singularity on the circle of convergence $|z| = \rho$, and $1/c(z, u)$, respectively $c(z, u)$, can be analytically continued to a region $|z| < \rho + \delta$, $|u| < 1 + \delta$, $|u - 1| > \frac{\varepsilon}{2}$ for some $\delta > 0$. \diamond

In contrast to the original hypothesis [H] in [70] we define hypothesis [H’] because we drop the condition $h(\rho, 1) > 0$ and we require it only for $\rho(u) = \rho = \text{const}$ for $|u - 1| < \varepsilon$. Note that this is necessary for Theorem 2.3.9.

Theorem 2.3.8 (Rayleigh limit theorem [70, Theorem 1]). *Let $c(z, u)$ be a bivariate generating function satisfying [H’], and additionally assume $h(\rho, 1) > 0$. If $g_u(\rho, 1) < 0$, then the sequence of random variables X_n defined by*

$$\mathbb{P}[X_n = k] = \frac{[z^n u^k]c(z, u)}{[z^n]c(z, 1)}$$

has a Rayleigh limit distribution, i.e.,

$$\frac{X_n}{\sqrt{n}} \xrightarrow{d} \mathcal{R}(\vartheta),$$

where $\vartheta = \frac{h(\rho, 1)^2}{2g_u(\rho, 1)^2}$ and $\mathcal{R}(\vartheta)$ has density $\vartheta x \exp(-\frac{\vartheta}{2}x^2)$ for $x \geq 0$. Expected value and variance are given by

$$\mathbb{E}(X_n) = \sqrt{\frac{\pi}{2\vartheta}} \sqrt{n} + \mathcal{O}(1) \quad \text{and} \quad \mathbb{V}(X_n) = \left(2 - \frac{\pi}{2}\right) \frac{n}{\vartheta} + \mathcal{O}(\sqrt{n}).$$

Moreover, we have the local law

$$\mathbb{P}[X_n = k] = \frac{\vartheta k}{n} \exp\left(-\frac{\vartheta k^2}{2n}\right) + \mathcal{O}((k+1)n^{-3/2}) + \mathcal{O}(n^{-1})$$

uniformly for all $k \geq 0$.

Theorem 2.3.9 (Half-normal limit theorem, Chapter 3). *Let $c(z, u)$ be a bivariate generating function satisfying [H']. If $g_z(\rho, 1) \neq 0$, $h_u(\rho, 1) \neq 0$, and $h(\rho, 1) = g_u(\rho, 1) = g_{uu}(\rho, 1) = 0$, then the sequence of random variables X_n defined by*

$$\mathbb{P}[X_n = k] = \frac{[z^n u^k]c(z, u)}{[z^n]c(z, 1)},$$

has a half-normal limiting distribution, i.e.,

$$\frac{X_n}{\sqrt{n}} \xrightarrow{d} \mathcal{H}(\sigma),$$

where $\sigma = \sqrt{2} \frac{h_u(\rho, 1)}{\rho g_z(\rho, 1)}$, and $\mathcal{H}(\sigma)$ has density $\frac{\sqrt{2}}{\sqrt{\pi}\sigma^2} \exp\left(-\frac{z^2}{2\sigma^2}\right)$ for $z \geq 0$.

Expected value and variance are given by

$$\mathbb{E}(X_n) = \sigma \sqrt{\frac{2}{\pi}} \sqrt{n} + \mathcal{O}(1) \quad \text{and}$$

$$\mathbb{V}(X_n) = \sigma^2 \left(1 - \frac{2}{\pi}\right) n + \mathcal{O}(\sqrt{n}).$$

Moreover, we have the local law

$$\mathbb{P}[X_n = k] = \frac{1}{\sigma} \sqrt{\frac{2}{\pi n}} \exp\left(-\frac{k^2/n}{2\sigma^2}\right) + \mathcal{O}\left(kn^{-3/2}\right) + \mathcal{O}\left(n^{-1}\right),$$

uniformly for all $k \geq 0$.

Moment scheme

The following scheme is an instance of the well-known method of moments. It represents a statement on the existence of the limit distribution of a sequence of random variables, when only the moments of the random variables in the sequence are known.

Theorem 2.3.10 (Fréchet and Shohat, [90]). *Let the $X_n, n \in \mathbb{N}$ be non-negative discrete random variables, satisfying the following properties*

1. *there exists an $n_0 \in \mathbb{N}$, such that the moments $\mathbb{E}(X_n^r)$ exist for all $r \in \mathbb{N}$ and all $n \geq n_0$;*
2. *for any $r \in \mathbb{N}$ there exist two constants $a_r, b_r \in \mathbb{R}$ independent on n (but they might depend on r), for which $a_r \leq \mathbb{E}(X_n^r) \leq b_r$ holds for all $n \in \mathbb{N}$.*

Then, there exists a subsequence $Y_i = X_{n_i}, i \in \mathbb{N}$ with $n_i < n_{i+1}$, such that

1. $\lim_{i \rightarrow \infty} \mathbb{E}(Y_i^r) = m_r$ exists for all $r \in \mathbb{N}$;
2. the subsequence $(Y_i)_{i \in \mathbb{N}}$ converges in distribution to one fixed random variable Y ;
3. the moments of Y exist and satisfy

$$\mathbb{E}(Y^r) = m_r.$$

2.4 SYMMETRIC POLYNOMIALS

One of our key tools will be the kernel method introduced in Section 1.3. As a result, especially in Chapter 4, we will encounter many determinant manipulations. These naturally lead to symmetric functions, which are the subject of this short section. This section mostly draws from Stanley’s very good introduction [174, Chapter 7].

Definition 2.4.1. *The complete homogeneous symmetric polynomials h_k of degree k in the n variables x_1, \dots, x_n are defined as*

$$h_k(x_1, \dots, x_n) = \sum_{1 \leq i_1 \leq i_2 \leq \dots \leq i_k \leq n} x_{i_1} x_{i_2} \cdots x_{i_k} = \sum_{\substack{\ell_1 + \ell_2 + \dots + \ell_n = k \\ \ell_i \geq 0}} x_1^{\ell_1} x_2^{\ell_2} \cdots x_n^{\ell_n}.$$

Example 2.4.2. It always holds that $h_0(x_1, \dots, x_n) = 1$. For $n = 2$ we get

$$\begin{aligned} h_1(x_1, x_2) &= x_1 + x_2, \\ h_2(x_1, x_2) &= x_1^2 + x_1 x_2 + x_2^2, \\ h_3(x_1, x_2) &= x_1^3 + x_1^2 x_2 + x_1 x_2^2 + x_2^3, \end{aligned}$$

as the polynomials of degree 1, 2 and 3, respectively.

The second class of polynomials are Schur polynomials. First, let us state their classical definition by determinants, see [174, Chapter 7.15].

Definition 2.4.3 (Schur polynomials – classical). *Let $\lambda = (\lambda_1, \dots, \lambda_n)$ be an integer partition, given as $\lambda_1 \geq \lambda_2 \geq \dots \geq \lambda_n > 0$ and $\delta := (n - 1, n - 2, \dots, 0)$. Then define the polynomials*

$$\begin{aligned} a_{\lambda+\delta}(x_1, x_2, \dots, x_n) &= a_{(\lambda_1+n-1, \lambda_2+n-2, \dots, \lambda_n)}(x_1, x_2, \dots, x_n) \\ &= \begin{vmatrix} x_1^{\lambda_1+n-1} & x_1^{\lambda_2+n-2} & \dots & x_1^{\lambda_n} \\ x_2^{\lambda_1+n-1} & x_2^{\lambda_2+n-2} & \dots & x_2^{\lambda_n} \\ \vdots & \vdots & & \vdots \\ x_n^{\lambda_1+n-1} & x_n^{\lambda_2+n-2} & \dots & x_n^{\lambda_n} \end{vmatrix}, \end{aligned}$$

where $|\cdot|$ denotes the determinant. The Schur polynomials are defined as the ratio

$$\begin{aligned} s_\lambda(x_1, x_2, \dots, x_n) &= \frac{a_{\lambda+\delta}(x_1, x_2, \dots, x_n)}{a_\delta(x_1, x_2, \dots, x_n)} \\ &= \frac{a_{(\lambda_1+n-1, \lambda_2+n-2, \dots, \lambda_n)}(x_1, x_2, \dots, x_n)}{a_{(n-1, n-2, \dots, 0)}(x_1, x_2, \dots, x_n)}. \end{aligned}$$

Note that due to the construction via determinants the $a_{\lambda+\delta}$ are alternating polynomials, i.e. the sign changes if any two variables

are swapped. Since they are alternating they are all divisible by the *Vandermonde determinant*, given by the special case

$$a_{\delta}(x_1, x_2, \dots, x_n) = \begin{vmatrix} x_1^{n-1} & x_1^{n-2} & \dots & 1 \\ x_2^{n-1} & x_2^{n-2} & \dots & 1 \\ \vdots & \vdots & \ddots & \vdots \\ x_n^{n-1} & x_n^{n-2} & \dots & 1 \end{vmatrix} = \prod_{1 \leq i < j \leq n} (x_i - x_j).$$

Thus, the Schur polynomials are symmetric functions because the numerator and denominator are both alternating.

Example 2.4.4. These are the first Schur polynomials in 2 variables:

$$s_{(0,0)}(x_1, x_2) = 1,$$

$$s_{(1,0)}(x_1, x_2) = \frac{1}{x_1 - x_2} \begin{vmatrix} x_1^2 & 1 \\ x_2^2 & 1 \end{vmatrix} = x_1 + x_2 = h_1(x_1, x_2),$$

$$s_{(2,0)}(x_1, x_2) = \frac{1}{x_1 - x_2} \begin{vmatrix} x_1^3 & 1 \\ x_2^3 & 1 \end{vmatrix} = x_1^2 + x_1x_2 + x_2^2 = h_2(x_1, x_2),$$

$$s_{(2,1)}(x_1, x_2) = \frac{1}{x_1 - x_2} \begin{vmatrix} x_1^3 & x_1 \\ x_2^3 & x_2 \end{vmatrix} = x_1x_2(x_1 + x_2).$$

The examples suggest a relation between certain Schur polynomials and complete homogeneous symmetric polynomials. The general result is given in the following Lemma 2.4.5.

Remark 5 (Schur polynomials – combinatorial). Alternatively, Schur polynomials can also be described combinatorially over semistandard Young tableaux:

$$s_{\lambda}(x_1, \dots, x_n) = \sum_T u^T = \sum_T x_1^{t_1} \cdots x_n^{t_n},$$

where the summation is over all semistandard Young tableaux T of shape λ . The exponents t_i for $i = 1, \dots, n$ count the occurrences of the number i in T . For more details we refer to [174, Chapter 7.10].

Lemma 2.4.5. Let $k \in \mathbb{N}$, then $s_{(k,0,\dots,0)}(x_1, \dots, x_n) = h_k(x_1, \dots, x_n)$.

Proof. We use the combinatorial representation of Schur functions from Remark 5. The semistandard Young tableaux of shape $\lambda = (k, 0, \dots, 0)$ has one row with k cells, where the numbers $1, \dots, n$ are added in a non-decreasing order. In other words,

$$s_{(k,0,\dots,0)}(x_1, x_2, \dots, x_n) = \sum_{\substack{t_1+t_2+\dots+t_n=k \\ t_i \geq 0}} x_1^{t_1} x_2^{t_2} \cdots x_n^{t_n} = h_k(x_1, x_2, \dots, x_n),$$

which are the complete homogeneous symmetric polynomials from Definition 2.4.1. \square

2.5 TOOLS FROM ANALYTIC COMBINATORICS

An important concept is the coefficient extraction from generating functions as introduced in Definition 1.2.2. We have already seen in several examples in Chapter 1 that if the generating function takes a simple form, one can use Taylor expansions of known functions to extract the coefficients. However, in general this will not be possible. In such cases *Cauchy's integral formula* proves to be useful.

Assume that the radius of convergence of $A(z) = \sum_{n \geq 0} a_n z^n$ is positive. Then, we have

$$[z^n]A(z) = \frac{1}{2\pi i} \int_{\gamma} \frac{A(z)}{z^{n+1}} dz,$$

where γ is a simple closed curve around the origin that lies completely inside the circle of convergence of $A(z)$, and the integral is taken in counter-clockwise direction.

The following theorem will prove useful several times in the subsequent discussion.

Theorem 2.5.1 ([85, Theorem VI.12]). *Let $A(z) = \sum a_n z^n$ and $B(z) = \sum b_n z^n$ be two power series with radii of convergence $\alpha > \beta \geq 0$, respectively. Assume that $B(z)$ satisfies the ratio test*

$$\frac{b_{n-1}}{b_n} \rightarrow \beta \quad \text{as } n \rightarrow \infty.$$

Then the coefficients of the product $F(z) = A(z) \cdot B(z)$ satisfy, provided $A(\beta) \neq 0$:

$$[z^n]F(z) \sim A(\beta)b_n \quad \text{as } n \rightarrow \infty.$$

Especially for the study of recursive structures we will need the complex version of the implicit function theorem. Without loss of generality we assume $(z_0, w_0) = (0, 0)$, and we consider here a function $F(z, w)$ that is analytic in the sense that it admits a convergent representation of the kind

$$F(z, w) = \sum_{n, k \geq 0} f_{n, k} z^n w^k, \quad |z| < R, \quad |w| < S,$$

for some $R, S > 0$.

Theorem 2.5.2 (Implicit function theorem, [85, Theorem B.4]). *Let F be bivariate analytic near $(0, 0)$. Assume that $F(0, 0) = 0$ and $F_w(0, 0) \neq 0$. Then, there exists a unique function $f(z)$ analytic in a neighborhood $|z| < \rho$ of 0 such that $f(0) = 0$ and*

$$F(z, f(z)) = 0, \quad |z| < \rho.$$

A useful complement to the implicit function theorem is the Weierstrass preparation theorem.

Theorem 2.5.3 (Weierstrass preparation theorem, [85, Theorem B.5]). Let $F = F(z_1, \dots, z_m)$ be an analytic function in a neighborhood of $(0, \dots, 0)$, such that $F(0, \dots, 0) = 0$ and $F(0, z_2, \dots, z_m) \neq 0$. Define a Weierstrass polynomial to be a polynomial of the form

$$W(z) = z^d + g_1 z^{d-1} + \dots + g_d,$$

where $g_j = g_j(z_2, \dots, z_m)$ is analytic near $(0, \dots, 0)$ with $g_j(0, \dots, 0) = 0$. Then, F admits a unique factorization

$$F(z_1, z_2, \dots, z_m) = W(z_1)X(z_1, \dots, z_m),$$

where $W(z)$ is a Weierstrass polynomial and X is analytic near $(0, \dots, 0)$ satisfying $X(0, \dots, 0) \neq 0$.

Proof. We refer to [64, 65] for an analytic presentation [85, Theorem B.5], or to [1, Chapter 16] for an algebraic presentation. \square

Basically, the Weierstrass preparation theorem states that implicitly defined functions (by the equation $F = 0$) are locally of the same nature as algebraic functions (corresponding to the equation $W = 0$). For our case, the case $m = 2$ is the most interesting one. In this case singularities of the solution can only be branch points. Hence, they possess Puiseux expansions at the singularities. This is of great importance with respect to the method of singularity analysis.

The next theorem can be thought of as a corollary of the previous two results. Especially in tree enumeration problems a certain form of a functional equation occurs, namely, $y = F(z, y)$. The structure somehow reflects the recursive decomposition of a tree into a root and several subtrees.

Theorem 2.5.4 ([66, Theorem 2.19]). Suppose that $F(z, y)$ is an analytic function in z, y around $z = y = 0$ such that $F(0, y) = 0$ and that all Taylor coefficients of F around 0 are real and non-negative. Then, there exists a unique analytic solution $y = y(z)$ of the functional equation

$$y = F(z, y),$$

with $y(0) = 0$ that has non-negative Taylor coefficients around 0.

If the region of convergence of $F(z, y)$ is large enough such that there exist positive solutions $z = z_0$ and $y = y_0$ of the system of equations

$$\begin{aligned} y &= F(z, y), \\ 1 &= F_y(z, y), \end{aligned}$$

with $F_z(z_0, y_0) \neq 0$ and $F_{yy}(z_0, y_0) \neq 0$, then $y(z)$ is analytic for $|z| < z_0$ and there exist functions $g(z), h(z)$ that are analytic around $z = z_0$ such that $y(z)$ has a representation of the form

$$y(z) = g(z) - h(z) \sqrt{1 - \frac{z}{z_0}}, \quad (31)$$

locally around $z = z_0$. We have $g(z_0) = y(z_0)$ and

$$h(z_0) = \sqrt{\frac{2z_0 F_z(z_0, y_0)}{F_{yy}(z_0, y_0)}}.$$

Moreover, (31) provides a local analytic continuation of $y(z)$ (for $\arg(z - z_0) \neq 0$).

If we assume that $[z^n]y(z) > 0$ for $n \geq n_0$, then $z = z_0$ is the only singularity of $y(z)$ on the circle $|z| = z_0$ and we obtain an asymptotic expansion for $[z^n]y(z)$ of the form

$$[z^n]y(z) = \sqrt{\frac{z_0 F_z(z_0, y_0)}{2\pi F_{yy}(z_0, y_0)}} z_0^{-n} n^{-3/2} \left(1 + \mathcal{O}(n^{-1})\right).$$

Part II

LATTICE PATHS

This part is devoted to the theory of directed lattice paths. Its key tools will be the kernel method and schemes for generating functions. Chapter 3 presents a new scheme for generating functions implying a half-normal limiting distribution. Additionally, it states three natural appearances of such a limiting distribution where this scheme can be used. Chapter 4 deals with directed lattice paths, when a boundary reflecting or absorbing condition is added to the classical models. Depending on the spatial coordinate, one of two sets of rules is applied, namely one for altitude zero and one for non-zero altitudes. In Chapter 5 some enumerative and asymptotic properties of lattice paths below a line of rational slope are analyzed. It also answers an open problem stated by Knuth. The main result is a new method to deal with periodic combinatorial problems. In Chapter 6 a new model for directed lattice paths is introduced. It allows catastrophes, which are jumps from any altitude to zero. A bijection with other lattice paths is given and limit laws for certain parameters such as, among others, the number of catastrophes, and the average size of a catastrophe are given.

3

A HALF-NORMAL DISTRIBUTION SCHEME AND APPLICATIONS TO LATTICE PATHS

This chapter is based on the article *A half-normal distribution scheme for generating functions* [181] that has recently been submitted to a journal. A preliminary version of this paper appeared in the Proceedings of the 27th International Conference on Probabilistic, Combinatorial and Asymptotic Methods for the Analysis of Algorithms (AofA 2016) [182].

In [69], Drmota and Soria provided general methods for the analysis of bivariate generating functions $F(z, u) = \sum f_{nk} z^n u^k$. In general, n is the length or size, and k is the value of a “marked” parameter. They continued their work in [70], where they derived three general theorems which identify the limiting distribution for a class of combinatorial schemes from certain properties of their associated bivariate generating function. These lead to a Rayleigh, a Gaussian, or a convolution of both distributions, see Section 2.1. We introduced the most important schemes for our purposes in Section 2.3.

In this chapter we extend the work of [70], by providing an additional limit theorem, Theorem 2.3.9, which reveals a half-normal distribution. This distribution is generated by the absolute value $|X|$ of a normally distributed random variable X with mean 0.

We also present three natural appearances of this distribution in lattice path theory. These results were discussed in the context of Motzkin walks in [182] and are now extended to the case of arbitrary aperiodic lattice paths. Despite them being well-studied objects [38, 63, 146], they still hide some mysterious properties. Our applications extend some examples of random walks presented by Feller in [80, Chapter III]. We show that the same phenomena appear which, to quote Feller, “not only are unexpected but actually come as a shock to intuition and common sense”.

Plan of this chapter. In Section 3.1, we present our main contribution: a scheme for bivariate generating functions leading to a half-normal distribution. In Section 1.6, we introduce lattice paths and establish the analytic framework which will be used in the subsequent sections. In Section 3.2, we apply our result to three parameters of walks: the number of returns to zero, the height, and the number of sign changes, where sign changes are only treated in the case of Motzkin walks. In the case of a zero drift a half-normal distribution appears in all cases. In Section 3.3, we give the proof of our main result: Theorem 2.3.9. In Section 3.4, we state a summary of our results and compare its different parameters in the case of Motzkin walks.

3.1 THE HALF-NORMAL THEOREM

An important concept in order to analyze more involved parameters of paths, is the one of marking. Let us briefly recall the concepts from Section 1.4.

Let $c(z) = \sum_n c_n z^n$ be the generating function of a combinatorial structure and $c(z, u) = \sum c_{nk} z^n u^k$ be the bivariate generating function where a parameter of interest has been marked, i.e., $c(z, 1) = c(z)$. We introduce a sequence of random variables $X_n, n \geq 1$, defined by

$$\mathbb{P}[X_n = k] = \frac{c_{nk}}{c_n} = \frac{[z^n u^k]c(z, u)}{[z^n]c(z, 1)},$$

where \mathbb{P} denotes the probability of the given event. As we are interested in the asymptotic distribution of the marked parameter among objects of size n where n tends to infinity, the probabilistic point of view is given by finding the limiting distribution of X_n .

Important combinatorial constructions are “sequences” or “sets of cycles” (in the case of exponential generating functions) which imply the following decomposition

$$c(z, u) = \frac{1}{1 - a(z, u)},$$

with a generating function $a(z, u)$ corresponding to the elements of the sequence, or the cycles, respectively. Another important and recurring phenomenon is the one of an algebraic singularity $\rho(u)$ of the square-root type such that $a(\rho(1), 1) = 1$. According to further analytic properties of $a(z, u)$ the limiting distribution of X_n is shown to be either Gaussian, Rayleigh, the convolution of Gaussian and Rayleigh (see [70, Theorems 1-3]), or half-normal (see Theorem 2.3.9).

We start with the general form of the analytic scheme. Let us recall the statement of hypothesis [H'] and Theorem 2.3.9 from Chapter 2.

Hypothesis [H']. Let $c(z, u) = \sum_{n,k} c_{nk} z^n u^k$ be a power series in two variables with non-negative coefficients $c_{nk} \geq 0$ such that $c(z, 1)$ has a radius of convergence of $\rho > 0$.

We suppose that $1/c(z, u)$ has the local representation

$$\frac{1}{c(z, u)} = g(z, u) + h(z, u) \sqrt{1 - \frac{z}{\rho}},$$

for $|u - 1| < \varepsilon$ and $|z - \rho| < \varepsilon$, $\arg(z - \rho) \neq 0$, where $\varepsilon > 0$ is some fixed real number, and $g(z, u)$, and $h(z, u)$ are analytic functions. Furthermore, we have $g(\rho, 1) = 0$.

In addition, $z = \rho$ is the only singularity on the circle of convergence $|z| = |\rho|$, and $1/c(z, u)$, respectively $c(z, u)$, can be analytically continued to a region $|z| < \rho + \delta, |u| < 1 + \delta, |u - 1| > \frac{\varepsilon}{2}$ for some $\delta > 0$. \diamond

Theorem (Half-normal limit theorem, Theorem 2.3.9). *Let $c(z, u)$ be a bivariate generating function satisfying [H']. If $g_z(\rho, 1) \neq 0$, $h_u(\rho, 1) \neq 0$, and $h(\rho, 1) = g_u(\rho, 1) = g_{uu}(\rho, 1) = 0$, then the sequence of random variables X_n defined by*

$$\mathbb{P}[X_n = k] = \frac{[z^n u^k]c(z, u)}{[z^n]c(z, 1)},$$

has a half-normal limiting distribution, i.e.,

$$\frac{X_n}{\sqrt{n}} \xrightarrow{d} \mathcal{H}(\sigma),$$

where $\sigma = \sqrt{2} \frac{h_u(\rho, 1)}{\rho g_z(\rho, 1)}$, and $\mathcal{H}(\sigma)$ has density $\frac{\sqrt{2}}{\sqrt{\pi}\sigma^2} \exp\left(-\frac{z^2}{2\sigma^2}\right)$ for $z \geq 0$. Expected value and variance are given by

$$\begin{aligned} \mathbb{E}(X_n) &= \sigma \sqrt{\frac{2}{\pi}} \sqrt{n} + \mathcal{O}(1) && \text{and} \\ \mathbb{V}(X_n) &= \sigma^2 \left(1 - \frac{2}{\pi}\right) n + \mathcal{O}(\sqrt{n}). \end{aligned}$$

Moreover, we have the local law

$$\mathbb{P}[X_n = k] = \frac{1}{\sigma} \sqrt{\frac{2}{\pi n}} \exp\left(-\frac{k^2/n}{2\sigma^2}\right) + \mathcal{O}\left(kn^{-3/2}\right) + \mathcal{O}\left(n^{-1}\right),$$

uniformly for all $k \geq 0$.

Remark 6. The assumption of a constant singularity in z given by ρ can be weakened to a singularity $\rho(u) = \rho(1) + \mathcal{O}((u - 1)^3)$, i.e., $\rho'(1) = \rho''(1) = 0$. However, no example is known where $\rho(u)$ is not constant in a neighborhood of $u \sim 1$.

3.2 APPLICATIONS TO LATTICE PATH COUNTING

The following examples are motivated by the nice presentation of Feller [80, Chapter III] about one-dimensional symmetric, simple random walks. Therein, the discrete time stochastic process $(S_n)_{n \geq 0}$ is defined by $S_0 = 0$ and $S_n = \sum_{j=1}^n X_j$, $n \geq 1$, where the $(X_i)_{i \geq 1}$ are iid Bernoulli random variables with $\mathbb{P}[X_i = 1] = \mathbb{P}[X_i = -1] = \frac{1}{2}$. These results are generalized to the case of aperiodic directed lattice paths. In particular compare [80, Problems 9-10] and [169, Remark of Barton] for returns to zero of symmetric and asymmetric random walks, respectively. Furthermore, see [80, Chapter III.5] for sign changes, and [80, Chapter III.7] for the height. See also the recent paper of Döbler [62] on Stein's method for these questions in which he derives bounds for the convergence rate in the Kolmogorov and the Wasserstein metric.

For the sake of brevity we will only mention the weak convergence law. However, in all cases the local law and the asymptotic expansions for mean and variance hold as well.

Returns to zero

A *return to zero* is a point of a walk of altitude 0 except for the starting point, in other words a return to the x -axis, see Figure 15. In order to count them we consider “minimal” bridges, in the sense that the bridges touch the x -axis only at the beginning and at the end. We call them *arches*. As a bridge is a sequence of such arches, we get their generating function in the form of $A(z) = 1 - \frac{1}{B(z)}$.

Lemma 3.2.1. *The generating function of arches $A(z)$ is for $z \rightarrow \rho$ of the kind*

$$A(z) = a(z) + b(z)\sqrt{1 - z/\rho},$$

where $a(z)$ and $b(z)$ are analytic functions in a neighborhood $\Omega \setminus (\rho, \infty)$ of ρ .

Proof. We know that $B(z) = z \sum_{j=1}^{\infty} \frac{u_j'(z)}{u_j(z)}$ is analytic for $|z| < \rho$, see [19, Theorem 3]. Due to the aperiodicity ρ is the only singular point on the circle of convergence. Furthermore, $u_1(z)$ is the only small branch which is singular there, hence

$$B(z) = \frac{C_1}{\sqrt{1 - z/\rho}} + \mathcal{O}(1), \quad C_1 := \frac{C}{2\tau}, \tag{32}$$

for $z \rightarrow \rho$. Then, Proposition 1.6.5 and (32) imply the desired decomposition. \square

The number of returns to zero of a bridge is the same as the number of arches it is constructed from. These numbers were analyzed in the more general model of the reflection-absorption model in [32]. The governing limit law behaves like a negative binomial distribution.

Here, we are interested in the number of returns to zero of walks which are unconstrained by definition. Every walk can be decomposed into a maximal initial bridge, and a walk that never returns to the x -axis, see Figure 12. Let us denote the generating function of this *tail* by $T(z)$.

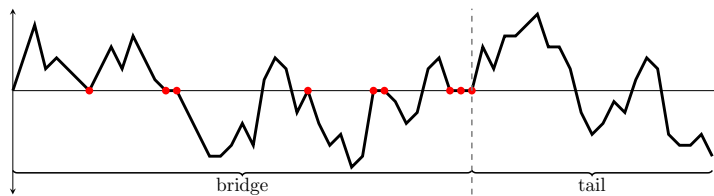

Figure 12: A walk with 9 returns to zero decomposed into a bridge and a tail.

As we want to count the number of returns to zero, we mark each arch by an additional parameter u and reconstruct the generating function of walks. This gives

$$W(z, u) = \frac{T(z)}{1 - uA(z)} = \frac{W(z)}{u + (1 - u)B(z)}, \quad \text{with} \quad T(z) = \frac{W(z)}{B(z)}.$$

Let us define the random variable X_n to stand for the number of returns to zero of a random walk of length n . Thus, $\mathbb{P}[X_n = k] = \frac{[u^k z^n]W(z, u)}{[z^n]W(z, 1)}$.

Theorem 3.2.2 (Limit law for returns to zero). *Let X_n denote the number of returns to zero of an aperiodic walk of length n . Let $\delta = P'(1)$ be the drift.*

1. *For $\delta \neq 0$ we get convergence to a geometric distribution:*

$$X_n \xrightarrow{d} \text{Geom} \left(\frac{1}{B(1/P(1))} \right);$$

2. *For $\delta = 0$ we get convergence to a half-normal distribution:*

$$\frac{X_n}{\sqrt{n}} \xrightarrow{d} \mathcal{H} \left(\sqrt{\frac{P(1)}{P''(1)}} \right).$$

Proof. We see that $[z^n]W(z, 1) = [z^n]W(z) = P(1)^n$. Due to the aperiodicity constraint $B(z)$ is only singular at ρ . Obviously, $W(z)$ is singular at $\rho_1 := \frac{1}{P(1)}$.

On the positive real axis the convex nature of $P(u)$ implies that $P(\tau)$ is its unique minimum. Hence, only two cases are possible: $\rho_1 < \rho$, if $\tau \neq 1$; or $\rho_1 = \rho$, if $\tau = 1$. These cases are also characterized by $\delta \neq 0$ or $\delta = 0$, respectively. In the first case $W(z)$ is responsible for the dominant singularity. Then we get (as $B(z)$ is analytic for $|z| < \rho$)

$$[z^n]W(z, u) = \frac{1}{B(\rho_1)} \frac{P(1)^n}{1 - u \left(1 - \frac{1}{B(\rho_1)}\right)} + o(P(1)^n).$$

Hence, the probability that a walk of length n has k returns to zero is for any fixed k

$$\mathbb{P}[X_n = k] = \frac{1}{B(\rho_1)} \left(1 - \frac{1}{B(\rho_1)}\right)^k + o(1).$$

Thus, the limit distribution is a geometric distribution with parameter $\lambda = \frac{1}{B(\rho_1)}$.

In the second case $\tau = 1$ or $\delta = 0$, we apply Theorem 2.3.9. By Lemma 3.2.1 we get that $1/W(z, u)$ has a decomposition of the kind (30). In particular, from (32) we get that

$$\frac{1}{W(z, u)} = \left(1 - \frac{z}{\rho}\right) u + \frac{C}{2}(1 - u) \sqrt{1 - \frac{z}{\rho}} + \mathcal{O} \left(\left(1 - \frac{z}{\rho}\right) (1 - u) \right),$$

for $z \rightarrow \rho$ and $u \rightarrow 1$, with $g(\rho, 1) = h(\rho, 1) = g_u(\rho, 1) = g_{uu}(\rho, 1) = 0$; and $g_z(\rho, 1) = -P(1)$ and $h_u(\rho, 1) = -\sqrt{\frac{P(1)}{2P''(1)}}$. Hence, Theorem 2.3.9 yields the result. \square

Height

For a path of length n we define the *height* as its maximally attained y -coordinate, see Figure 13. Formally, let $\omega = (\omega_k)_{k=0}^n$ be a walk. Then its height is given by $\max_{k \in \{0, \dots, n\}} \omega_k$.

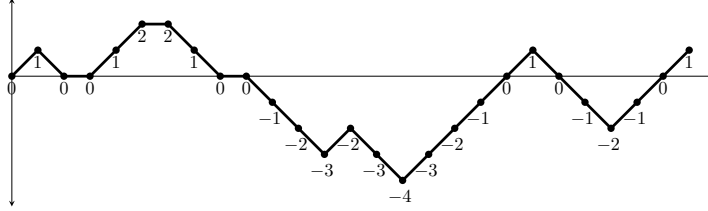

Figure 13: A Motzkin walk of height 2. The relative heights are given at every node.

In order to analyze the distribution of heights, we define the bivariate generating function $F(z, u) = \sum_{n,h \geq 0} f_{n,h} z^n u^h$. The coefficient $f_{n,h}$ represents the number of walks of height h among walks of length n .

Let $M(z, u) = \sum_{n,h \geq 0} m_{n,h} z^n u^h$ be the generating function of meanders, where $m_{n,h}$ is the number of meanders of length n ending at final altitude h . Banderier and Flajolet derived in [19, Theorem 2] its closed-form as

$$M(z, u) = \frac{\prod_{j=1}^c (u - u_j(z))}{u^c (1 - zP(u))} = -\frac{1}{p_d z} \prod_{\ell=1}^d \frac{1}{u - v_\ell(z)}. \tag{33}$$

Theorem 3.2.3. *The bivariate generating function of walks (where z marks the length, and u marks the height of the walk) is given by*

$$\begin{aligned} F(z, u) &= \frac{W(z)M(z, u)}{M(z)} \\ &= -\frac{1}{p_d z} \left(\prod_{j=1}^c \frac{1}{1 - u_j(z)} \right) \left(\prod_{\ell=1}^d \frac{1}{u - v_\ell(z)} \right). \end{aligned} \tag{34}$$

Proof. Banderier and Nicodème derived in [24, Theorem 2] the generating function $F^{[-\infty, h]}(z)$ for walks staying always below a wall $y = h$:

$$F^{[-\infty, h]}(z) = \frac{1 - \sum_{i=1}^d \left(\frac{1}{v_i}\right)^{h+1} \prod_{1 \leq j \leq d, j \neq i} \frac{1 - v_j}{v_i - v_j}}{1 - zP(1)}.$$

From this we directly get the generating function $F^{[h]}(z)$ for walks that have height exactly h . For $h \geq 1$ it equals

$$\begin{aligned} F^{[h]}(z) &= F^{[-\infty, h]}(z) - F^{[-\infty, h-1]}(z) \\ &= \sum_{i=1}^d \frac{v_i - 1}{1 - zP(1)} \left(\frac{1}{v_i}\right)^{h+1} \prod_{1 \leq j \leq d, j \neq i} \frac{1 - v_j}{v_i - v_j}. \end{aligned}$$

The last formula also holds for $h = 0$. Finally, marking the heights by u and summing over all possibilities gives

$$F(z, u) = \sum_{h \geq 0} u^h F^{[h]}(z) = \frac{\prod_{j=1}^d (1 - v_j)}{1 - zP(1)} \sum_{i=1}^d \frac{1}{u - v_i} \prod_{1 \leq j \leq d, j \neq i} \frac{1}{v_i - v_j}.$$

Note that $M(z) = -\frac{1}{p_d z} \frac{1}{\prod_{j=1}^d (1 - v_j)}$, see [19, Corollary 1]. Hence, the first factor gives $\frac{W(z)}{M(z)}$.

What remains is to analyze the sum. Putting everything on a common denominator, we get that $\sum_{i=1}^d \frac{1}{u - v_i} \prod_{1 \leq j \leq d, j \neq i} \frac{1}{v_i - v_j}$ is equal to

$$\left(\prod_{i=1}^d \frac{1}{u - v_i} \right) \underbrace{\frac{\sum_{i=1}^d (-1)^{i+1} \left(\prod_{j \neq i} v_j \right) \prod_{k < \ell, k, \ell \neq i} (v_k - v_\ell)}{\prod_{k < \ell} (v_k - v_\ell)}}_{=1}.$$

The last fraction is equal to 1, because the numerator is equal to the Vandermonde determinant of the denominator that has been expanded with respect to the first column of all 1s. \square

This identity is obviously directly related to the kernel equation. Its simple structure suggests a combinatorial interpretation, or even a direct combinatorial proof. In order to answer this question, we will analyze it in more detail now. Let us start with its factor $\frac{W(z)}{M(z)} = \prod_{j=1}^c \frac{1}{1 - u_j(z)}$.

As in the previous section we introduce the notion of *negative meanders* staying always below the x -axis and denote their generating function by $M_-(z)$. Furthermore, let *strictly negative meanders* be negative meanders that never return to the x -axis (but start at 0), and denote their generating function by $M_{<0}(z)$.

Proposition 3.2.4. *The generating functions of strictly negative meanders and negative meanders are given by*

$$M_{<0}(z) = \prod_{j=1}^c \frac{1}{1 - u_j(z)},$$

$$M_-(z) = E(z)M_{<0}(z) = \frac{(-1)^{c-1}}{p_{-c}z} \prod_{j=1}^c \frac{u_j(z)}{1 - u_j(z)}.$$

Proof. The key idea is that negative meanders are meanders after mirroring the coordinate system along the x -axis. By doing so, the step polynomial $P(u) = \sum_{i=-c}^d p_i u^i$ changes to the *mirrored step polynomial*

$$\tilde{P}(u) = \sum_{i=-d}^c p_{-i} u^i.$$

The small branches $\tilde{u}_i(z)$, which satisfy $1 - z\tilde{P}(\tilde{u}_i(z)) = 0$ are given by

$$\tilde{u}_i(z) = \frac{1}{v_i(z)},$$

where $v_i(z)$ are the large branches of the original kernel equation $1 - zP(u) = 0$. Finally, by (33) and because of $P(1) = \tilde{P}(1)$ we get

$$M_-(z) = \frac{\prod_{j=1}^c (1 - \tilde{u}_j(z))}{1 - zP(1)} = \frac{(-1)^{d-1}}{p_d z} \left(\prod_{j=1}^d \frac{1}{v_j(z)} \right) \prod_{j=1}^c \frac{1}{1 - u_j(z)},$$

due to the factorization of the kernel equation. Then, the first factor $\frac{(-1)^{d-1}}{p_d z} \left(\prod_{j=1}^d \frac{1}{v_j(z)} \right)$ is equal to the generating function of excursions $E(z)$ which can also be expressed in terms of the small branches.

For the second result note that any meander can be uniquely decomposed into an initial negative excursion and a strictly negative meander. \square

Before we proceed, let us illustrate the previous results for the case of Motzkin walks with step polynomial $P(u) = \frac{p_{-1}}{u} + p_0 + p_1 u$.

Corollary 3.2.5. *The bivariate generating function of Motzkin walks with marked height is given by*

$$F_M(z, u) = -\frac{1}{p_1 z} \frac{1}{1 - u_1(z)} \frac{1}{u - v_1(z)}$$

This representation possesses a simple combinatorial interpretation. Recall that the generating function of excursions is given by $E(z) = \frac{1}{z p_1 v_1(z)}$, see [19]. Thus,

$$F_M(z, u) = \frac{1}{1 - p_1 z u E(z)} M_-(z).$$

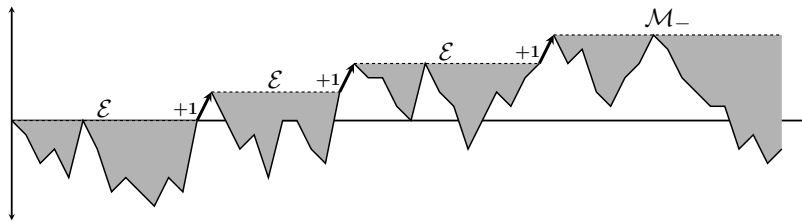

Figure 14: The first passage decomposition of a Motzkin walks into (negative) excursions and a trailing negative meander.

The above generating function just represents the decomposition of a walk into a sequence of marked blocks, which are (negative) excursions (cf. Lemma 3.2.7) followed by an up step, and a negative

meander at the end, see Figure 14. Note that a similar interpretation exists for other step sets.

We now turn our attention back to the limit laws for the height of walks. Let X_n be the random variable for the height of a random walk of length n . Thus, $\mathbb{P}[X_n = k] = \frac{[u^k z^n]F(z,u)}{[z^n]F(z,1)} = \frac{[u^k z^n]F(z,u)}{P(1)^n}$. In contrary to the previous examples the behavior will not be the same for $\delta < 0$ and $\delta > 0$. This confirms the intuition, since the drift strongly affects the height of a random walk.

The following theorem concludes this section with the governing limit laws for the height of walks. Note in particular the different rescaling factors in each case.

Theorem 3.2.6 (Limit law for the height). *Let X_n denote the height of a walk of length n . Let $\delta = P'(1)$ be the drift, and $\rho_1 = \frac{1}{P(1)}$.*

1. *For $\delta < 0$ the limit distribution is discrete and characterized in terms of the large branches:*

$$\lim_{n \rightarrow \infty} \mathbb{P}[X_n = k] = [u^k] \omega(u), \quad \text{where } \omega(u) = \prod_{j=1}^d \frac{1 - v_j(\rho_1)}{u - v_j(\rho_1)}.$$

2. *For $\delta = 0$ the standardized random variable converges to a half-normal distribution:*

$$\frac{X_n}{\sqrt{n}} \xrightarrow{d} \mathcal{H} \left(\sqrt{\frac{P''(1)}{P(1)}} \right).$$

3. *For $\delta > 0$ the standardized random variable converges to a normal distribution:*

$$\frac{X_n - \mu n}{\sigma \sqrt{n}} \xrightarrow{d} \mathcal{N}(0, 1),$$

with

$$\mu = \frac{P'(1)}{P(1)}, \quad \sigma^2 = \frac{P''(1)}{P(1)} + \frac{P'(1)}{P(1)} - \left(\frac{P'(1)}{P(1)} \right)^2.$$

Proof. From the structure of the generating function in (34) it is obvious that the result strongly depends on the limit law of the final altitude of meanders. This was analyzed in [19, Theorem 6]. In several cases we will apply the *domination property* of the small branches [19]:

$$|u_j(z)| < |u_1(z)| \leq \tau \leq |v_1(z)| < |v_\ell(z)|, \quad \text{for } |z| < \rho,$$

and $j = 2, \dots, c$ as well as $\ell = 2, \dots, d$.

Let us start with $\delta < 0$. In this case it proves convenient to consider the equivalent representation of (34) given by

$$F(z, u) = \frac{1}{1 - zP(1)} \prod_{\ell=1}^d \frac{1 - v_\ell(z)}{u - v_\ell(z)}.$$

In this case we know that $\tau > 1$, implying $\rho > \rho_1$ and that the dominant singularity arises at $z = \rho_1$. The product of the large branches is analytic for $|z| < \rho$ as was already noted in [19]. Hence, by standard methods [85, Theorem VI.12 (Real analysis asymptotics)] we get the asymptotic expansion:

$$[z^n]F(z, u) = P(1)^n \prod_{\ell=1}^d \frac{1 - v_\ell(\rho_1)}{u - v_\ell(\rho_1)} + o(P(1)^n).$$

The dominant term is the product of d geometric distributions with parameters $v_\ell(\rho_1)$.

In the case of a zero drift, $\delta = 0$, we have $\tau = 1$. Thus, $P(\tau) = P(1)$ and the singularities arises at $\rho = \rho_1 = 1/P(1)$. This means that the singularities of the two factors coincide, and we can apply Theorem 2.3.9.

Let $\varepsilon > 0$. Then, for $|z - \rho| < \varepsilon$, $|u - 1| < \varepsilon$, and $\arg(z - \rho) \neq 0$ we consider

$$\frac{1}{F(z, u)} = -p_a z(1 - u_1(z))(1 - v_1(z)) \underbrace{\left(\prod_{j=2}^c (1 - u_j(z)) \right)}_{=: \bar{U}_1(z)} \underbrace{\left(\prod_{\ell=2}^d (u - v_\ell(z)) \right)}_{=: \bar{V}_1(z, u)}.$$

The products $\bar{U}_1(z)$ and $\bar{V}_1(z, u)$ are analytic for $|z| \leq \rho$. However, the branches $u_1(z)$ and $v_1(z)$ both possess a square root singularity, compare (18). By Proposition 1.6.5 we have the desired decomposition

$$\frac{1}{F(z, u)} = g(z, u) + h(z, u)\sqrt{1 - z/\rho},$$

where $g(z, u)$ and $h(z, u)$ are analytic functions. In particular, the asymptotic expansion reads as follows

$$\begin{aligned} \frac{1}{F(z, u)} &= \kappa \left(C(1 - z/\rho) - (u - 1)\sqrt{1 - z/\rho} \right) + \mathcal{O} \left((1 - z/\rho)^{3/2} \right) \\ &\quad + \mathcal{O} \left((u - 1)(1 - z/\rho)^{1/2} \right), \end{aligned}$$

where κ is a non-zero constant. We immediately see that $g(\rho, 1) = h(\rho, 1) = g_u(\rho, 1) = g_{uu}(\rho, 1) = 0$, and that $g_z(\rho, 1) = -\kappa C/\rho$, and $h_u(\rho, 1) = -\kappa$.

Hence, Theorem 2.3.9 yields the result with the constant

$$\sigma = \sqrt{2} \frac{h_u(\rho, 1)}{\rho g_z(\rho, 1)} = \sqrt{\frac{P''(1)}{P(1)}}.$$

Finally, in the case $\delta > 0$ the same reasoning as in [19] gives the result, as the perturbation by $M_{<0}(z)$ does not pose any problems.

Yet, an alternative proof can be given via the perturbed supercritical sequence scheme, Proposition 2.3.5. In particular, we recognize the following structure in (34):

$$F(z, u) = q(z, u) \frac{1}{1 - uh(z)},$$

where $q(z, u) = \frac{M_{<0}(z)}{v_1(z)p_d z} \prod_{\ell=2}^d \frac{1}{u-v_\ell(z)}$, and $h(u) = \frac{1}{v_1(z)}$. This scheme is supercritical because $h(z)$ is singular at ρ , and we get $h(\rho) = 1/\tau > 0$ due to (18) and the crucial fact that $\delta > 0 \Leftrightarrow \tau < 1$. Note that in this case we have $\tau < 1$ and $u_1(\rho) < 1$. Therefore, by the domination property $q(z, u)$ is analytic for $|z| < \rho$, where $\rho > 1$.

Finally, note that $h(0) = 0$ because $\lim_{z \rightarrow 0} v_1(z) = \infty$. This implies that after standardization the height satisfies a Gaussian distribution. The asymptotic expected value and variance are then computed with a variant of Lemma 3.2.13 for general step set. As $u_1(z)$ and $v_1(z)$ are conjugated, the results for negative drift for $u_1(z)$ are the ones for positive drift for $v_1(z)$. \square

Remark 7 (Variant of Lemma 3.2.13). At the end of the last proof we used a generalization of Lemma 3.2.13. We want to remark that for general step set only the case of a negative drift for $u_1(z)$ is still valid. The case of a positive drift has a different value. In the case of Motzkin paths it holds because $u_1(z)v_1(z) = \frac{p-1}{p_1} = \tau^2$ and $\frac{1}{v_1(z)}$ is the small branch of the mirrored step set, see the proof of Proposition 3.2.4 for details. In general we get from the kernel equation that $\left(\prod_{j=1}^c u_j(z)\right) \left(\prod_{\ell=1}^d v_\ell(z)\right) = \frac{p-c}{p_d}$. Thus, the constant which appears for positive drift is

$$-\frac{p-c}{p_d} \frac{1}{\left(\prod_{j \neq 1}^c u_j(\rho_1)\right) \left(\prod_{\ell \neq 1}^d v_\ell(\rho_1)\right)}.$$

However, the values still only differ by this constant.

Sign changes of Motzkin walks

We say that nodes which are strictly above the x -axis have a *positive sign* denoted by “+”, whereas nodes which are strictly below the x -axis have a *negative sign* denoted by “-”, and nodes on the x -axis are *neutral* denoted by “0”. This notion easily transforms a walk $\omega = (\omega_n)_{n \geq 0}$ into a sequence of signs. In such a sequence a *sign change* is defined by either the pattern $+(0)-$ or $-(0)+$, where (0) denotes a non-empty sequence of zeros, see Figure 15.

The main observation in this context is the non-emptiness of the sequence of zeros. Geometrically this means that a walk has to touch the x -axis when passing through it. This means that we can count the number of sign changes by counting the number of maximal parts above and below the x -axis. The idea is to decompose a walk into an alternating sequence of positive (above the x -axis) and negative (below) excursions terminated by a positive or negative meander.

We introduce two new terms: *positive excursions* are “traditional” excursions, i.e., they are required to stay above the x -axis, whereas *negative excursions* are walks which start at zero, end on the x -axis, but are required to stay below the x -axis.

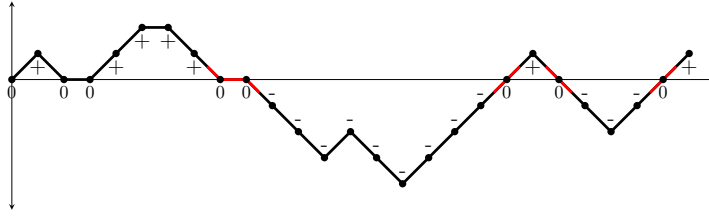

Figure 15: A Motzkin walk with 7 returns to zero and 4 sign changes. The positive, neutral or negative signs of the walks are indicated by +, 0, or −, respectively.

Lemma 3.2.7. *Among all walks of length n , the number of positive excursions is equal to the number of negative excursions.*

Proof. Traversing the steps in reversed order, bijectively maps positive excursions to negative ones. \square

We define the bivariate generating function $B(z, u) := b_{n,k}z^n u^k$, where $b_{n,k}$ denotes the number of bridges of size n having k sign changes. Furthermore, we define

$$C(z) := \frac{1}{1 - p_0 z},$$

as the generating function of *chains*, which are walks constructed solely from the jumps of height 0. Then, the generating function of excursions starting with a +1 jump is

$$E_1(z) = \frac{E(z)}{C(z)} - 1,$$

since we need to exclude all excursions which start with a chain or are a chain. Due to Lemma 3.2.7 this is also the generating function for excursions starting with a −1 jump.

Theorem 3.2.8. *The bivariate generating function of bridges (where z marks the length, and u marks the number of sign changes of the walk) is given by*

$$B(z, u) = C(z) \left(1 + \frac{2E_1(z)}{1 - uE_1(z)} \right). \tag{35}$$

Proof. A bridge is either a chain, which has zero sign changes, or it is not a chain. In the latter it is an alternating sequence of positive and negative excursions, starting with either of them. We decompose it uniquely into such excursions, by requiring that all except the first one start with a non-zero jump. Therefore the first excursion is counted by $E(z) - C(z)$, whereas all others are counted by $E_1(z)$. The decomposition is shown in Figure 16. \square

We start our analysis by locating the dominant singularities of $B(z, u)$. Therefore we first state some inherent structural results of the model which follow from direct computations.

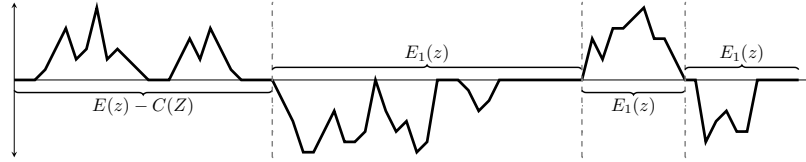

Figure 16: A bridge is an alternating sequence of positive and negative excursions. Here, it starts with a positive excursion, followed by excursions starting with a non-zero jump.

Lemma 3.2.9. *The structural constant τ which is the unique positive root of $P'(u) = 0$ is $\tau = \sqrt{\frac{p-1}{p_1}}$. The structural radius results in $\rho = \frac{1}{P(\tau)} = \frac{1}{p_0 + 2\sqrt{p-1}p_1}$.*

Let X_n be the random variable for the number of sign changes of a random bridge of length n . Thus, $\mathbb{P}[X_n = k] = \frac{[u^k z^n]B(z, u)}{[z^n]B(z, 1)}$.

Theorem 3.2.10 (Limit law for sign changes of bridges). *Let X_n denote the number of sign changes of a Motzkin bridge of length n . Then for $n \rightarrow \infty$ the normalized random variable has a Rayleigh limit distribution*

$$\frac{X_n}{\sqrt{n}} \xrightarrow{d} \mathcal{R}(\sigma) \quad \text{and} \quad \sigma = \frac{\tau}{2} \sqrt{\frac{P''(\tau)}{P(\tau)}},$$

where $\tau = \sqrt{\frac{p-1}{p_1}}$ and $\mathcal{R}(\sigma)$ has the density $\frac{x}{\sigma^2} \exp\left(-\frac{x^2}{2\sigma^2}\right)$ for $x \geq 0$.

Proof (Sketch). We will apply the first limit theorem of Drmota and Soria, [70, Theorem 1]. (The conditions of Hypothesis [H] are the same as for Hypothesis [H'] with the additional requirement that $h(\rho, 1) > 0$.)

Let us first analyze $B(z, 1)$. Its dominant singularity is at ρ , as $1/p_0 > \rho = 1/(p_0 + 2\sqrt{p-1}p_1)$. Next we determine the decomposition at $z = \rho$ and $u = 1$. From Proposition 1.6.5 it follows that $E_1(z)$ has a local representation of the kind

$$E_1(z) = a_E(z) + b_E(z)\sqrt{1 - z/\rho},$$

where $a_E(z)$ and $b_E(z)$ are analytic functions around $z = \rho$ with $a_E(\rho) = 1$ and $b_E(\rho) = -2C/\tau$. From (35) we see that

$$B(z, u) = C(z)F(E_1(z), u), \quad \text{where} \quad F(y, u) = \frac{1 - uy}{1 - y(u - 2)}.$$

We can use the Taylor series expansion of

$$\frac{1}{F(y, u)} = \sum_{n, k \geq 0} f_{nk}(y - 1)^n (u - 1)^k,$$

with $f_{00} = 0$ and $f_{10} = -1/2$ to show the desired decomposition:

$$\frac{1}{B(z, u)} = C(z)^{-1}F(E_1(z), u)^{-1} = g(z, u) + h(z, u)\sqrt{1 - z/\rho}.$$

We have $g(\rho, 1) = f_{00} = 0$, $h(\rho, 1) = (1 - \rho p_0)f_{10}b_E(\rho) = 2C\rho p_1 > 0$ and $g_u(\rho, 1) = (1 - \rho p_0)f_{01} = -\tau\rho p_1 < 0$. Applying Lemma 3.2.9 gives the result. \square

Finally, we consider sign changes of walks. Since we want to count the number of sign changes we need to know whether a bridge ended with a positive or negative sign. Let *positive bridges* be bridges whose last non-zero signed node was positive, and *negative bridges* be bridges whose last non-zero signed node was negative. Their generating functions are denoted by $B_+(z, u)$ and $B_-(z, u)$, respectively. Figure 16 shows a negative bridge.

Lemma 3.2.11. *The number of positive and negative bridges is the same and given by*

$$B_+(z, u) = \frac{B(z, u) - C(z)}{2} = \frac{E(z) - C(z)}{1 - uE_1(z)}.$$

Proof. The result is a direct consequence of Lemma 3.2.7. We have seen that a bridge is a sequence of excursions, see Figure 16. Mapping all positive excursions to negative ones, and vice versa, gives a bijection between positive and negative bridges. \square

Proposition 3.2.12. *The bivariate generating function of walks $W(z, u) = \sum_{n,k \geq 0} w_{nk} z^n u^k$ where w_{nk} is the number of all walks of length n with k sign changes, is given by*

$$W(z, u) = B(z, u) \frac{W(z)}{B(z)} + B_+(z, u) \left(\frac{W(z)}{B(z)} - 1 \right) (u - 1),$$

where $W(z) = \frac{1}{1 - zP(1)}$ is the generating function of walks.

Proof. Combinatorially, a walk is either a bridge or a bridge concatenated with a meander that does not return to the x -axis again. In the second case an additional sign change appears if the bridge ends with a negative sign and continues with a meander always staying strictly above the x -axis, or vice versa. By Lemma 3.2.11 the desired form follows. \square

For the main result, we need the following (technical) lemma about the small branch $u_1(z)$. Recall from Lemma 3.2.9 that $\tau^2 = p_{-1}/p_1$. It can also be used to simplify the results on the height from Theorem 3.2.6 in the case of Motzkin walks because $u_1(z)v_1(z) = \frac{p_{-1}}{p_1}$, see Table 5.

Lemma 3.2.13. *Let $P(u) = p_{-1}u^{-1} + p_0 + p_1u$. Let $u_1(z)$ be the small branch of the kernel equation $1 - zP(u) = 0$ with $\lim_{z \rightarrow 0} u_1(z) = 0$, and define $\rho_1 := 1/P(1)$. Then*

$$u_1(\rho_1) = \begin{cases} 1, & \text{for } \delta < 0, \\ \tau^2, & \text{for } \delta > 0, \end{cases} \quad u_1'(\rho_1) = \begin{cases} -\frac{P(1)^2}{P'(1)}, & \text{for } \delta < 0, \\ \tau^2 \frac{P(1)^2}{P'(1)}, & \text{for } \delta > 0, \end{cases}$$

$$u_1''(\rho_1) = \begin{cases} -\left(\frac{P(1)}{P'(1)}\right)^3 (P(1)P''(1) - 2P'(1)^2), & \text{for } \delta < 0, \\ \tau^2 \left(\frac{P(1)}{P'(1)}\right)^3 (P(1)P''(1) - 2P'(1)^2), & \text{for } \delta > 0. \end{cases}$$

Proof. In both cases, $\delta < 0$ and $\delta > 0$, $u_1(z)$ is regular at ρ_1 . As $u_1(z)$ is monotonically increasing we must have $u_1(\rho_1) < u_1(\rho) = \tau = \sqrt{p_{-1}/p_1}$. Then, from the kernel equation $1 - zP(u_1(z)) = 0$ for all $|z| < \rho$, we get the desired result. For the second and third claim one uses the implicit derivative of the kernel equation and the previous results. \square

The next theorem concludes this discussion. Its proof is similar to the one of Theorem 3.2.2.

Theorem 3.2.14 (Limit law for sign changes). *Let X_n denote the number of sign changes of Motzkin walks of length n . Let $\delta = P'(1)$ be the drift.*

1. *For $\delta \neq 0$ we get convergence to a geometric distribution:*

$$X_n \xrightarrow{d} \text{Geom}(\lambda), \quad \text{with} \quad \lambda = \begin{cases} \frac{p_1}{p_{-1}}, & \text{for } \delta < 0, \\ \frac{p_{-1}}{p_1}, & \text{for } \delta > 0. \end{cases}$$

2. *For $\delta = 0$ we get convergence to a half-normal distribution:*

$$\frac{X_n}{\sqrt{n}} \xrightarrow{d} \mathcal{H} \left(\frac{1}{2} \sqrt{\frac{P''(1)}{P(1)}} \right).$$

Proof. Let us start with an analysis of the dominant singularity. The most important term decomposes into

$$\frac{W(z)}{B(z)} = \frac{1}{1 - zP(1)} \frac{u_1(z)}{zu_1'(z)}.$$

The first factor is singular at $\rho_1 = 1/P(1)$ but the second one is singular at $\rho = 1/P(\tau)$. As we know, $P(\tau) \leq P(1)$. Thus, either both are singular at the same time, or only $W(z)$ is responsible for the singularity.

In the first case, again the key idea is to use the coefficient asymptotics for the product of a singular and an analytic function [85, Theorem VI.12]. In particular for $\delta \neq 0$ only $W(z)$ is singular at the dominant singularity. Hence, the coefficient asymptotics is given by its asymptotic expansion times the other functions evaluated at $z = \rho_1$.

The results from Lemma 3.2.13 directly give

$$B(\rho_1) = \begin{cases} -\frac{P(1)}{\delta}, & \text{for } \delta < 0, \\ \frac{P(1)}{\delta}, & \text{for } \delta > 0. \end{cases} \quad (36)$$

Then some tedious calculations show for $\delta < 0$ that

$$\mathbb{P}[X_n = k] = \frac{[z^n u^k]W(z, u)}{[z^n]W(z)} = [u^k] \left(-\frac{\delta}{p-1} \right) \frac{1}{1 - u \frac{p_1}{p-1}} + o(1).$$

This is a geometric distribution with parameter $\lambda = \frac{p_1}{p-1}$. For $\delta > 0$ the analogous result holds.

In the second case of $\delta = 0$ we also have $\tau = 1$ and $\rho = \rho_1$. Then, we can apply Theorem 2.3.9. A reasoning along the lines of Theorem 3.2.10 shows that

$$\frac{1}{W(z, u)} = g(z, u) + h(z, u) \sqrt{1 - z/\rho},$$

where $g(z, u)$ and $h(z, u)$ are analytic functions. We omit the tedious calculations and directly derive the asymptotic form for $z \rightarrow \rho$. For the tail we get by (32) the expansion

$$\frac{W(z)}{B(z)} = \frac{2}{C \sqrt{1 - z/\rho}} + \mathcal{O}(1),$$

for $z \rightarrow \rho$, where $C = \sqrt{2 \frac{P(1)}{P''(1)}}$. Thus, we get

$$\begin{aligned} \frac{1}{W(z, u)} &= \frac{2C\rho p_{-1}}{\tau^2(u-3)(u+1)} \left(\frac{4C}{\tau(u-3)} \left(1 - \frac{z}{\rho} \right) + (u-1) \sqrt{1 - \frac{z}{\rho}} \right) \\ &\quad + \mathcal{O} \left(\left(1 - \frac{z}{\rho} \right)^2 \right) + \mathcal{O} \left(\left(1 - \frac{z}{\rho} \right) (1-u) \right), \end{aligned}$$

for $|u-1| < \varepsilon$, $|z-\rho| < \varepsilon$ and $\arg(z-\rho) \neq 0$, with $g(\rho, 1) = h(\rho, 1) = g_u(\rho, 1) = g_{uu}(\rho, 1) = 0$; and $g_z(\rho, 1) = -\frac{C^2 p_{-1}}{\tau^3}$ and $h_u(\rho, 1) = -\frac{C\rho p_{-1}}{2\tau^2}$. Hence, Theorem 2.3.9 yields the final result with the constant $\sigma = \sqrt{2} \frac{h_u(\rho, 1)}{\rho g_z(\rho, 1)} = \frac{1}{2} \sqrt{\frac{P''(1)}{P(1)}}$. \square

Using (36) the results of Theorem 3.2.2 can be simplified, and we get a geometric law with parameter $\lambda = \frac{|\delta|}{P(1)} = \frac{|p_1 - p_{-1}|}{P(1)}$ for $\delta \neq 0$. In Table 5 we will see a comparison of the parameters.

3.3 PROOF OF THEOREM 2.3.9

We first list some useful formulae related to the half-normal distribution. Technical results have been derived in [178], like the representation of the characteristic function [178, Equation (15)].

Lemma 3.3.1. *Let γ be the Hankel contour starting from “ $+e^{2\pi i}\infty$ ”, passing around 0 and tending to $+\infty$. Then*

$$\frac{1}{2\pi i} \int_{\gamma} \frac{e^{-z}}{z + is\sqrt{-z}} dz = \varphi_{\mathcal{H}}(\sqrt{2}s),$$

where

$$\varphi_{\mathcal{H}}(t) = \sqrt{\frac{2}{\pi}} \int_0^{\infty} e^{itz} e^{-z^2/2} dz,$$

denotes the characteristic function of the half-normal distribution.

Proof. It is sufficient to compare the Taylor expansion around $s = 0$. On the one hand we get by the Hankel integral representation of $\Gamma(t)^{-1} = \frac{1}{2\pi i} \int_{\gamma} (-z)^{-t} e^{-z} dz$ that

$$\begin{aligned} \frac{1}{2\pi i} \int_{\gamma} \frac{e^{-z}}{z + is\sqrt{-z}} dz &= \frac{1}{2\pi i} \int_{\gamma} \frac{e^{-z}}{z} \sum_{k \geq 0} (is)^k (-z)^{-\frac{k}{2}} dz \\ &= \sum_{k \geq 0} (is)^k \frac{1}{2\pi i} \int_{\gamma} (-z)^{-(\frac{k}{2}+1)} e^{-z} dz \\ &= \sum_{k \geq 0} \frac{(is)^k}{\Gamma\left(\frac{k}{2} + 1\right)}. \end{aligned}$$

On the other hand we have

$$\begin{aligned} \varphi_{\mathcal{H}}(t) &= \sqrt{\frac{2}{\pi}} \int_0^{\infty} \sum_{n \geq 0} \frac{(it)^n}{n!} x^n e^{-x^2/2} dx \\ &= \sqrt{\frac{2}{\pi}} \sum_{n \geq 0} \frac{(it)^n}{n!} 2^{\frac{n-1}{2}} \int_0^{\infty} y^{\frac{n-1}{2}} e^{-y} dy \\ &= \frac{1}{\sqrt{\pi}} \sum_{n \geq 0} (it)^n 2^{\frac{n}{2}} \frac{\Gamma\left(\frac{n+1}{2}\right)}{\Gamma(n+1)} = \sum_{n \geq 0} \frac{1}{\Gamma\left(\frac{n}{2} + 1\right)} \left(\frac{it}{\sqrt{2}}\right)^n, \end{aligned}$$

where we used the duplication formula $\Gamma(z)\Gamma(z + \frac{1}{2}) = 2^{1-2z} \sqrt{\pi} \Gamma(2z)$ in the last equality. \square

Lemma 3.3.2. *Let γ be as in Lemma 3.3.1. Then*

$$\frac{1}{2\pi i} \int_{\gamma} \frac{e^{-s\sqrt{-z}-z}}{\sqrt{-z}} dz = \frac{1}{\sqrt{\pi}} e^{-s^2/4}.$$

Proof. The result follows from the substitution $z = w^2$, followed by completing the square in the exponent, which results in a Gaussian integral. \square

Remark 8. Alternatively the result follows directly from [70, Lemma 7], by an indefinite integration with respect to s .

Proof of Theorem 2.3.9. We follow the same ideas as in the proof of [70, THEOREM 1]. Let us first derive asymptotic expansions for mean and variance. This will bring us on track of the half-normal distribution. Since $\rho(u) = \rho$ we have

$$c(z, u) = \frac{1}{g(z, u) + h(z, u) \sqrt{1 - z/\rho}}, \quad (37)$$

and due to $g(\rho, 1) = h(\rho, 1) = 0$, and $g_z(\rho, 1) \neq 0$ we get

$$\begin{aligned} [z^n]c(z, 1) &= -[z^n] \frac{1}{\rho g_z(\rho, 1)} \frac{1}{1 - z/\rho} + \mathcal{O}(\sqrt{1 - z/\rho}) \\ &= -\frac{\rho^{-n}}{\rho g_z(\rho, 1)} \left(1 + \mathcal{O}(n^{-1/2})\right). \end{aligned} \quad (38)$$

Because of $h_u(\rho, 1) \neq 0$, and $h(\rho, 1) = g_u(\rho, 1) = g_{uu}(\rho, 1) = 0$ we get

$$\begin{aligned} [z^n]c_u(z, 1) &= [z^n] \left(-\frac{h_u(\rho, 1)}{(\rho g_z(\rho))^2} \frac{1}{(1 - z/\rho)^{3/2}} + \mathcal{O}((1 - z/\rho)^{-1}) \right) \\ &= -\frac{2h_u(\rho, 1)\rho^{-n}}{(\rho g_z(\rho))^2} \sqrt{\frac{n}{\pi}} \left(1 + \mathcal{O}(n^{-1/2})\right). \end{aligned}$$

Hence,

$$\mathbb{E}(X_n) = \frac{[z^n]c_u(z, 1)}{[z^n]c(z, 1)} = \frac{2h_u(\rho, 1)}{\rho g_z(\rho)} \sqrt{\frac{n}{\pi}} \left(1 + \mathcal{O}(n^{-1/2})\right).$$

Alike, due to $g_{uu}(\rho, 1) = 0$ we derive

$$\begin{aligned} [z^n]c_{uu} &= -[z^n] \frac{2h_u(\rho, 1)^2}{(\rho g_z(\rho, 1))^3} \frac{1}{(1 - z/\rho)^2} + \mathcal{O}\left((1 - z/\rho)^{-3/2}\right) \\ &= -\frac{2h_u(\rho, 1)^2}{(\rho g_z(\rho, 1))^3} \rho^{-n} n \left(1 + \mathcal{O}(n^{-1/2})\right), \end{aligned}$$

and

$$\mathbb{V}(X_n) = \frac{[z^n]c_{uu}(z, 1)}{[z^n]c(z, 1)} = 2 \left(\frac{h_u(\rho, 1)}{\rho g_z(\rho, 1)} \right)^2 n + \mathcal{O}(n^{1/2}).$$

These results strongly suspect that the underlying limit distribution is a half-normal one. We will show that this is indeed the case by deriving the asymptotic form of the characteristic function of X_n/\sqrt{n} . Since

$$\mathbb{E}(e^{itX_n/\sqrt{n}}) = \frac{[z^n]c(z, e^{\frac{it}{\sqrt{n}}})}{[z^n]c(z, 1)}, \quad (39)$$

we need to expand $[z^n]c(z, u)$ for $u = e^{it/\sqrt{n}} = 1 + \frac{it}{\sqrt{n}} + \mathcal{O}(n^{-1})$. To achieve this, we will apply Cauchy's formula

$$[z^n]c(z, u) = \frac{1}{2\pi i} \int_{\Gamma} c(z, u) \frac{dz}{z^{n+1}} \quad (40)$$

for the following path of integration $\Gamma = \Gamma_1 \cup \Gamma_2$:

$$\begin{aligned} \Gamma_1 &= \left\{ z = \rho \left(1 + \frac{s}{n}\right) : s \in \gamma' \right\}, \\ \Gamma_2 &= \left\{ z = Re^{i\theta} : R = \rho \left|1 + \frac{\log^2 n + i}{n}\right|, \right. \\ &\quad \left. \arg \left(1 + \frac{\log^2 n + i}{n}\right) \leq |\theta| \leq \pi \right\}, \end{aligned}$$

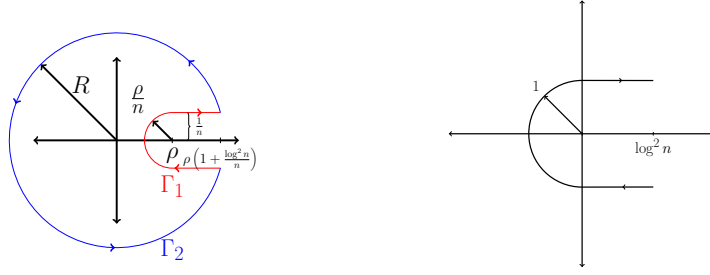

Figure 17: Hankel contour decomposition of Γ (left), and contour of γ' (right).

where $\gamma' = \{s : |s| = 1, \Re s \leq 0\} \cup \{s : 0 < \Re s < \log^2 n, \Im s = \pm 1\}$ is the major part of a Hankel contour γ , see Figure 17.

Firstly, we investigate the path Γ_1 . The substitution $z = \rho(1 + \frac{s}{n})$ transforms Γ_1 into γ' . Let us now look at its effect on $g(z, u)$ and $h(z, u)$:

$$\begin{aligned} g(z, e^{it/\sqrt{n}}) &= g_z(\rho, 1) \rho \frac{s}{n} + \mathcal{O}\left(\frac{s}{n^{3/2}}\right), \\ h(z, e^{it/\sqrt{n}}) &= h_u(\rho, 1) \frac{it}{\sqrt{n}} + \mathcal{O}\left(\frac{s}{n}\right), \end{aligned} \quad (41)$$

as $g_u(\rho, 1) = 0$ and $h(\rho, 1) = 0$. Note that this behavior is different from the one in [70, Theorem 1], where the differences are $g_u(\rho, 1) = 1$ and $h(\rho, 1) = 0$. Thus, we get

$$\begin{aligned} \frac{1}{2\pi i} \int_{\Gamma_1} c(z, u) \frac{dz}{z^{n+1}} &= \\ &= \frac{\rho^{-n}}{2\pi i} \int_{\gamma'} \frac{e^{-s} (1 + \mathcal{O}(\frac{s}{n}))}{g_z(\rho, 1) \rho \frac{s}{n} + h_u(\rho, 1) it \frac{\sqrt{-s}}{n} + \mathcal{O}(\frac{s}{n^{3/2}})} \frac{ds}{n} \\ &= \frac{\rho^{-n}}{\rho g_z(\rho, 1)} \frac{1}{2\pi i} \int_{\gamma'} \frac{e^{-s}}{s + \sqrt{-s} i \frac{h_u(\rho, 1)t}{\rho g_z(\rho, 1)}} ds + \mathcal{O}(\rho^{-n} n^{-1/2}). \end{aligned} \quad (42)$$

In the first equality we used $(1 + \frac{s}{n})^{-n-1} = e^{-s} (1 + \mathcal{O}(\frac{s}{n}))$. For the second equality, note that $g_z(\rho, 1), h_u(\rho, 1), t \in \mathbb{R}$. Thus, the integrand of the generic integral

$$I(\gamma') := \int_{\gamma'} \frac{e^{-s}}{\sqrt{-s} - iCt} ds,$$

with $C \in \mathbb{R}$ is only singular for $s = (Ct)^2 > 0$. Hence, for large enough n we get that $\log^2 n > (Ct)^2$. Thus, closing the curve γ' by adding the segment from $\log^2 n + i$ to $\log^2 n - i$ we get by the residue theorem that

$$\begin{aligned} I(\gamma') &= \underbrace{\int_{\log^2 n - i}^{\log^2 n + i} \frac{e^{-s}}{\sqrt{-s} - iCt} du}_{=\mathcal{O}\left(\frac{e^{-\log^2 n}}{\log n}\right)} - 2\pi i \underbrace{\operatorname{Res}_{s=(Ct)^2} \left(\frac{e^{-s}}{\sqrt{-s} - iCt} \right)}_{=-i2Cte^{-(Ct)^2}} = \mathcal{O}(1). \end{aligned}$$

Next, we extend the integral γ' to γ . By elementary bounds the missing parts are negligible. In particular the curve $\gamma \setminus \gamma'$ consists of two segments:

$$\begin{aligned} I(\gamma \setminus \gamma') &= \int_{\infty}^{\log^2 n} \frac{e^{-(u-i)} du}{\sqrt{-(u-i)} - iCt} + \int_{\log^2 n}^{\infty} \frac{e^{-(u+i)} du}{\sqrt{-(u+i)} - iCt} \\ &= \mathcal{O}\left(e^{-\log^2 n}\right). \end{aligned}$$

We get by (42) and Lemma 3.3.1

$$\frac{1}{2\pi i} \int_{\Gamma_1} c(z, u) \frac{dz}{z^{n+1}} = \frac{\rho^{-n}}{\rho g_z(\rho, 1)} \varphi_{\mathcal{H}}\left(\frac{\sqrt{2}h_u(\rho, 1)}{\rho g_z(\rho, 1)} t\right) + \mathcal{O}\left(\rho^{-n} n^{-1/2}\right). \quad (43)$$

What remains is to bound the remaining part of the integral associated with the contour Γ_2 . There are $\varepsilon_1 > 0$ and $\delta_1 > 0$ such that

$$\max_{|z|=z_1, |\arg z| \geq \vartheta_1} |c(z, u)| = |c(z_1 e^{i\vartheta_1}, u)|,$$

for $1 \leq z_1 \leq 1 + \delta_1$ and $|u - 1| < \varepsilon_1$. This follows from the facts that $c_{nk} \geq 0$, that $z = \rho$ is the only singularity on the circle of convergence, and that $c(z, u)$ has the local representation (37). Using the expansions from (41) we directly get

$$\left| c\left(\rho \left(1 + \frac{\log^2 n + i}{n}\right), e^{\frac{it}{\sqrt{n}}}\right) \right| = \mathcal{O}\left(\frac{n}{\log^2 n}\right),$$

and therefore by using again $(1 + \frac{s}{n})^{-n-1} = e^{-s} (1 + \mathcal{O}(\frac{s}{n}))$ we obtain

$$\frac{1}{2\pi i} \int_{\Gamma_2} c(z, u) \frac{dz}{z^{n+1}} = \mathcal{O}\left(\frac{\rho^{-n} n}{\log^2 n} e^{-\log^2 n}\right). \quad (44)$$

Note that it is crucial at this point that γ' continues on the real axis until $\log^2 n$ and not just until $\log n$. Otherwise we would get $\mathcal{O}(\frac{\rho^{-n}}{\log n})$ at this stage, which would contradict the desired final error term.

Putting everything from (38), (39), (40), (43), and (44) together, we get

$$\mathbb{E}(e^{itX_n/\sqrt{n}}) = \varphi_{\mathcal{H}}\left(\frac{\sqrt{2}h_u(\rho, 1)}{\rho g_z(\rho, 1)} t\right) + \mathcal{O}\left(n^{-1/2}\right).$$

This proves the weak limit theorem.

In order to prove the local limit theorem we again use Cauchy's formula

$$[z^n u^k] c(z, u) = \frac{1}{(2\pi i)^2} \int_{\Gamma} \int_{\Delta} c(z, u) \frac{du}{u^{k+1}} \frac{dz}{z^{n+1}},$$

where $\Gamma = \Gamma_1 \cup \Gamma_2$ is as above, and Δ chosen properly.

For $z = \rho \left(1 + \frac{s}{n}\right) \in \Gamma_1$ the mapping $u \mapsto c(z, u)$ has a polar singularity at $u_0 = 1 + \frac{t_0}{\sqrt{n}}$, where

$$t_0 = \frac{\rho g_z(\rho, 1)}{h_u(\rho, 1)} \sqrt{-s} + \mathcal{O}\left(\frac{\sqrt{s}}{n}\right),$$

with residue

$$\frac{1}{h_u(\rho, 1)} \sqrt{\frac{n}{-s}} \left(1 + \mathcal{O}\left(\frac{\sqrt{s}}{n}\right)\right).$$

Hence, we apply the residue theorem and transform Δ in such a way that

$$\begin{aligned} & \frac{1}{2\pi i} \int_{\Delta} c(z, u) \frac{du}{u^{k+1}} \\ &= -\frac{u_0^{-(k+1)}}{h_u(\rho, 1)} \sqrt{\frac{n}{-s}} \left(1 + \mathcal{O}\left(\frac{\sqrt{s}}{n}\right)\right) + \frac{1}{2\pi i} \int_{|u|=1+\varepsilon_2} c(z, u) \frac{du}{u^{k+1}} \\ &= -\frac{1}{h_u(\rho, 1)} \sqrt{\frac{n}{-s}} \exp\left(-\frac{k}{\sqrt{n}} \frac{\rho g_z(\rho, 1)}{h_u(\rho, 1)} \sqrt{-s}\right) \left(1 + \mathcal{O}\left(\frac{\sqrt{s}}{n}\right)\right) \\ & \quad + \mathcal{O}\left(\frac{ks}{n}\right) + \mathcal{O}\left((1 + \varepsilon_2)^{-k}\right). \end{aligned}$$

The expansion $\left(1 + \frac{t_0}{\sqrt{n}}\right)^{-k-1} = e^{-kt_0/\sqrt{n}} \left(1 + \mathcal{O}\left(\frac{\sqrt{s}}{n}\right) + \mathcal{O}\left(\frac{ks}{n}\right)\right)$ was used in the last equality.

Therefore, by Lemma 3.3.2 we get

$$\begin{aligned} & \frac{1}{(2\pi i)^2} \int_{\Gamma} \int_{\Delta} c(z, u) \frac{du}{u^{k+1}} \frac{dz}{z^{n+1}} \\ &= -\frac{\rho^{-n}}{h_u(\rho, 1)} \int_{\gamma'} \frac{\exp\left(-s - \frac{k}{\sqrt{n}} \frac{\rho g_z(\rho, 1)}{h_u(\rho, 1)} \sqrt{-s}\right)}{2\pi i \sqrt{-s}} \left(1 + \mathcal{O}\left(\frac{\sqrt{s}}{n}\right)\right) \\ & \quad + \mathcal{O}\left(\frac{ks}{n}\right) \frac{ds}{\sqrt{n}} + \mathcal{O}\left(\rho^{-n} \frac{(1 + \varepsilon_2)^{-k}}{\sqrt{n}}\right) \\ &= -\frac{\rho^{-n}}{h_u(\rho, 1)} \frac{1}{\sqrt{\pi n}} \exp\left(-\frac{k^2}{4n} \left(\frac{\rho g_z(\rho, 1)}{h_u(\rho, 1)}\right)^2\right) + \mathcal{O}\left(\frac{\rho^{-n}}{n}\right) \\ & \quad + \mathcal{O}\left(\rho^{-n} \frac{k}{n^{3/2}}\right) + \mathcal{O}\left(\rho^{-n} \frac{(1 + \varepsilon_2)^{-k}}{\sqrt{n}}\right). \end{aligned}$$

By similar elementary considerations as before we obtain

$$\max_{z \in \Gamma_2, |u|=1} c(z, u) = \mathcal{O}\left(\frac{n}{\log^2 n}\right).$$

Hence, by choosing $\Delta = \{u : |u| = 1\}$ for $z \in \Gamma_2$ we can estimate the remaining integral by

$$\frac{1}{(2\pi i)^2} \int_{\Gamma} \int_{\Delta} c(z, u) \frac{du}{u^{k+1}} \frac{dz}{z^{n+1}} = \mathcal{O}\left(\frac{n}{\log^2 n} e^{-\log^2 n}\right),$$

which concludes the proof of the local limit theorem. \square

3.4 CONCLUSION

Drmotá and Soria [70] presented three schemes leading to three different limiting distributions: Rayleigh, normal, and a convolution of both. This chapter can be seen as an extension, by adding Theorem 2.3.9 yielding a half-normal distribution to this family.

The question may arise, how Theorem 2.3.9 behaves in the situation of a singularity $\rho(u)$ with $\rho'(1) \neq 0$ or $\rho''(1) \neq 0$, compare Remark 6. This remains an object for future research.

However, the more interesting question is if more “natural” appearances of such situations exist. Another known example is the limit law of the final altitude of meanders with zero drift in the reflection-absorption model in [26]. Chronologically, this was the starting point for the research of the results of this chapter. But this distribution also appears in number theory, see [93].

Let us recall the results in the case of Motzkin walks. In Table 5 we see a comparison of the parameters. Obviously, the situation depends strongly on the drift. In particular it is interesting to observe the duality between the cases $\delta < 0$ and $\delta > 0$ for returns to zero and sign changes. Intuitively this is expected due to the symmetry of these problems on walks. We see that returns to zero are dictated by the absolute difference, whereas sign changes depend on the ratio of weights of up- and down-jumps.

The critical case of a zero drift is to be the most delicate one, as it changes the nature of the law. In this case the limiting probability functions are concentrated around zero. In particular the expected value for $\Theta(n)$ trials grows like $\Theta(\sqrt{n})$ and not linearly. Equipped with the presented tools they might still be a “shock to intuition and common sense” but should not come “unexpected” anymore.

drift	returns to zero	sign changes	height
$\delta < 0$	$\text{Geom} \left(\frac{p_{-1}-p_1}{P(1)} \right)$	$\text{Geom} \left(\frac{p_1}{p_{-1}} \right)$	$\text{Geom} \left(\frac{p_1}{p_{-1}} \right)$
$\delta = 0$	$\mathcal{H} \left(\sqrt{\frac{P(1)}{P''(1)}} \right)$	$\mathcal{H} \left(\frac{1}{2} \sqrt{\frac{P''(1)}{P(1)}} \right)$	$\mathcal{H} \left(\sqrt{\frac{P''(1)}{P(1)}} \right)$
$\delta > 0$	$\text{Geom} \left(\frac{p_1-p_{-1}}{P(1)} \right)$	$\text{Geom} \left(\frac{p_{-1}}{p_1} \right)$	Normal distribution

Table 5: Summary of the limit laws for Motzkin walks.

4

THE REFLECTION-ABSORPTION MODEL FOR DIRECTED LATTICE PATHS

This chapter is based on joint work with Cyril Banderier. A preliminary version of the presented results has been published in the Proceedings of the 25th International Conference on Probabilistic, Combinatorial and Asymptotic Methods for the Analysis of Algorithms (AofA 2014) [26].

In Brownian motion theory, many possible boundary conditions for a Brownian-like process have been considered (e.g. absorption, killed Brownian motion, reflected Brownian motion, ... see [79]). Solving a stochastic differential equation with a reflecting boundary condition is known as the Skorokhod problem (see [170]). Such models appear e.g. in queuing theory (see [125]). In this chapter, we want to investigate properties of a discrete equivalent of such models, namely directed lattice paths in \mathbb{Z}^2 , having a reflecting boundary at $y = 0$.

If one considers lattice paths which are “killed” or “absorbed” at $y = 0$, then this is equivalent to the model analyzed in [19]. In what follows, we want to compare the basic properties (exact enumeration, asymptotics, limit laws) of these two discrete models (absorption versus reflection). In particular, we will consider Łukasiewicz paths, which are present in numerous fields like algebra, analysis of algorithms, combinatorics, language theory, probability theory and biology. This broad applicability is due to a bijection with simple families of trees, see e.g. [141]. The enumerative and analytic properties of such lattice paths were considered in [21] where limit laws for the area beneath Łukasiewicz paths are derived, and also in [51] where they are used to model polymers in chemistry, or e.g. in [24], which tackles the problem of enumeration and asymptotics of such walks of bounded height.

Our key tools will be the kernel method and analytic combinatorics [85]. However, as we will see, the situation is more complicated in the case of a reflecting boundary: first, bad luck, one does not have a nice product formula for the generating function anymore (unlike the Banderier-Flajolet model [19]), second, the drift still plays a key role, but also does a “second” drift at 0, and last but not least, several simultaneous singular behaviors can happen.

Furthermore, we will mainly apply singularity analysis in order to extract asymptotic expansions of several parameters. The phenomena we will mostly encounter are due to a so-called *square root singularity*. This arises from a natural factorization of the kernel (coming from the kernel method) into several branches. Such phenomena appear

repeatedly when dealing with combinatorial structures, see e.g. [69, 70, 85].

This chapter builds mainly on the work done in [19]. Therein the class of directed lattice paths in \mathbb{Z}^2 (under the absorption model) was investigated thoroughly by means of analytic combinatorics (see [85]).

Plan of this chapter. First, in Section 4.1, the reflection-absorption model and the general framework are introduced. The needed bivariate generating function is defined and the governing functional equation is derived and solved: Here the “kernel method” plays the most significant role in order to obtain the generating function (as typical for many combinatorial objects which are recursively defined with a “catalytic parameter”, see [46]).

In Section 4.2, we turn our attention to Łukasiewicz paths, and the asymptotic number of excursions is given. As a part of this we derive the limit laws for the number of returns to zero of excursions. We encounter three different behaviors which result in a Gaussian, a Rayleigh and a discrete limit distribution. In Section 4.3 we investigate bridges in the reflection-absorption model and state the limit laws for the number of returns to zero of bridges. The behavior is similar to the one in the case of excursions, and the same limit distributions appear.

Section 4.4 is dedicated to meanders. We establish the asymptotic number of meanders, and the expected length of randomly generated meanders for the absorption model. Note that these are trivial in the reflection model. Furthermore, we restrict the probability space to the absorption model and reformulate the previous results in this restricted setting. This gives the last results a more intuitive meaning. Then we derive the expected final altitude for meanders of size n , which gives us access to the underlying limit laws for the expected final altitude of meanders. On the one hand we encounter again a Gaussian, a Rayleigh, and a discrete limit law, but on the other hand one case leads to a half normal limit distribution.

The technical proofs of the main theorems are found in Section 4.6.

At the end we present recurrence relations on the moments for the final altitude in Appendix 4.5. In Appendix 3 a summary of all introduced constants is given.

Notation for this chapter. In order to distinguish the generating functions of excursions and bridges in the two models, we denote the excursions and meanders of the Banderier-Flajolet model introduced in Section 1.6 by $\tilde{E}(z)$ and $\tilde{B}(z)$, whereas the ones from the reflection-absorption model are denoted by $E(z)$ and $B(z)$, respectively.

4.1 THE REFLECTION-ABSORPTION MODEL

Let us consider directed walks on \mathbb{N}^2 , with a weighted step set \mathcal{S} , starting at the origin, confined to the upper half plane, and which

have another weighted step set S_0 on the boundary $y = 0$. This construction is motivated by the idea of modeling a reflecting or absorbing “wall” on the boundary. All such walks are called *meanders*, and the meanders ending on the abscissa are called *excursions* (see Table 1).

This walk model is thus encoded by two *jump polynomials*: $P(u)$ and $P_0(u)$ are Laurent polynomials describing the allowed jumps when the walk is at altitude $k > 0$ or $k = 0$, respectively. We fix $c, d, c_0, d_0 \in \mathbb{N}$ and introduce the following notation:

$$P(u) = \sum_{i=-c}^d p_i u^i, \quad P_0(u) = \sum_{i=-c}^d p_{0,i} u^i, \quad P_0^{\geq}(u) = \sum_{i=0}^d p_{0,i} u^i.$$

In order to exclude trivial cases we require $p_{-c}, p_d, p_{0,-c}, p_{0,d} \neq 0$. The weights are probabilities, which means that $p_i, p_{0,i} \geq 0$ and $P(1) = P_0(1) = 1$. Then, these jump polynomials characterize the *reflection-absorption model*: depending on the chosen weights, the boundary behaves like a reflecting or an absorbing wall. We talk about the *reflection model* if $P_0^{\geq}(u) = P_0(u)$, while we talk about the *absorption model* if $P_0^{\geq}(u) \neq P_0(u)$.

Example 4.1.1. Let us compare the reflection-absorption model with some well-known models. For this purpose we choose bridges of Dyck-paths, i.e. paths with step set $\mathcal{S} = \{-1, 1\}$, of length 4. There are in total 6 of them, shown in the first column of Table 6. If we choose one of these uniformly at random, each of these cases is chosen with probability $1/6$.

In the absolute value model [119] every path is transformed into a meander, by the following procedure. We go through the path from left to right and construct a new path, by assigning every point the absolute value of its y -coordinate. In other words (x, y) is mapped to $(x, |y|)$. For the case of bridges, this can also be seen, as flipping every arch which is below the x -axis up. Thereby we get 2 possible paths: the first row in Table 6 which consist of one single arch and the second one which consists of 2 arches. The first case can be constructed from 2 bridges, whereas the second one can be obtained out of 4 cases. Hence, this results in the respective probabilities $1/3$ and $2/3$.

As the last two cases we consider these excursions in the reflection and the absorption model, where we choose the probabilities to be $1/2$ for all weights. This results in the last two columns. Note that the absolute value model and the excursions model are in general not equivalent (see Footnote 1).

From this table, one can already see one paradox associated to the reflection model: one may think that the “reflection” will make the walk go far away from the x -axis. However, this is in part counter-balanced by the fact that 0 has a “heavier” weight in this model (no loss of mass here, contrary to the absorption model). Accordingly, there will be some interplay between the boundary, the drift of the

walk and the drift at 0, see Section 4.4. We quantify this in our next sections.

Dyck path	bridges, uniform model	absolute value of bridges	excursions, ref. model	excursions, abs. model
	$\frac{1}{6}$	$\frac{1}{3}$	$\frac{1}{3}$ ¹	$\frac{1}{2}$
	$\frac{1}{6}$	$\frac{2}{3}$	$\frac{2}{3}$	$\frac{1}{2}$
	$\frac{1}{6}$	0	0	0
	$\frac{1}{6}$	0	0	0
	$\frac{1}{6}$	0	0	0
	$\frac{1}{6}$	0	0	0

Table 6: Different constraints on the boundary $y = 0$ lead to different probabilistic models. We give the probabilities of Dyck bridges of length 4 in the uniform, absolute value, reflection, and absorption model.

Bivariate generating function of walks

A *bridge* is a simple path that starts in the origin and ends on the x -axis. Examples of bridges are shown in the above Tables 2 and 6.

Definition 4.1.2. We define the generating function of walks as

$$W(z, u) := \sum_{n,k \geq 0} W_{n,k} u^k z^n = \sum_{n \geq 0} w_n(u) z^n = \sum_{k \geq 0} W_k(z) u^k,$$

where the polynomials $w_n(u)$ describe the possible positions after n steps and where $W_k(z)$ are the generating functions of walks starting at 0 and ending at altitude k . The number $W_{n,k}$ represents the ratio of walks of length n which end at altitude k among all walks of length n . In particular, $W_0(z)$ is the generating function of bridges.

Theorem 4.1.3 (Generating function for walks). *The bivariate generating function of paths in the reflection-absorption model (with z marking size and u marking final altitude) relative to a simple set of steps \mathcal{S} for altitudes*

¹ The absolute value and the reflection model are in general not equivalent if the jumps (with their weights) are not symmetric: For $P(u) = pu + qu^{-1}$ the probability of the first path in the reflection model is $p/(1+p)$.

$k \neq 0$ and a simple set of steps S_0 for altitude $k = 0$ is a rational function. The associated jump polynomials are $P(u)$ and $P_0(u)$, respectively. It is given by

$$W(z, u) = \frac{1 - z(P(u) - P_0(u))W_0(z)}{1 - zP(u)}, \tag{45}$$

with $W_0(z)$ as the generating function of bridges in the reflection-absorption model.

Proof. The polynomials $w_n(u)$ fulfill the following recurrence relation

$$w_0(u) = 1, \quad w_{n+1}(u) = P(u)\{u^{\neq 0}\}w_n(u) + P_0(u)\{u^0\}w_n(u),$$

where $\{u^{\neq 0}\}$ is the linear operator extracting all terms in the power series except the constant one. The other operators are defined analogously. Multiplying by z^{n+1} and summing over all $n \geq 0$ we derive the following functional equation

$$W(z, u) = 1 + (zP(u)W(z, u) - zP(u)W_0(z)) + zP_0(u)W_0(z). \tag{46}$$

Solving for $W(z, u)$ gives the result. □

Remark 9. Formula (45) is only useful if one also has the generating function of bridges $W_0(z)$. One could think of different techniques to extract $W_0(z)$. Unfortunately, all of the ones we tried failed. First, rearranging the equation to get the kernel $1 - zP(u)$ on one side and a perturbation on the other side gives the structure needed for the kernel method. But it is not allowed to insert the small branches, as $W(z, u)$ is a Laurent-series in u . Second, using Cauchy’s coefficient formula to extract the coefficient of u^0 only gives a tautology.

However, in Section 4.3 we will see how to compute $W_0(z)$ in the simpler case of Łukasiewicz walks. We will see two different proofs. The first one is a combinatorial one. It uses a recursive construction from known building blocks of the Banderier-Flajolet model. This however only works because of the easier structure of Łukasiewicz walks. The second one is an analytic proof. It extracts the $[u^0]$ coefficient but on the level of formal power series. This also works in general, but then complications arise from the necessary simplifications which are needed to get the final structure. Again, in the case of Łukasiewicz walks this is doable. It is possible that this last approach can be extended to general walks. Yet we were not able to find it so far.

Bivariate generating function of meanders and excursions

A *meander* is a simple path that starts in the origin and is constrained to stay above the x -axis. An *excursion* is a meander that ends on the x -axis. Examples are shown in the above Tables 2 and 6.

Definition 4.1.4. We define the generating function of meanders to be

$$F(z, u) := \sum_{n,k \geq 0} F_{n,k} u^k z^n = \sum_{n \geq 0} f_n(u) z^n = \sum_{k \geq 0} F_k(z) u^k,$$

where the polynomials $f_n(u)$ describe the possible positions after n steps and where $F_k(z)$ are the generating functions of walks starting at 0 and ending at altitude k . The number $F_{n,k}$ represents the ratio of meanders of length n which end at altitude k among all possible walks of length n .

The next theorem lays the foundation for the ongoing analysis. Readers who are familiar with the kernel method and its applications may skip its proof. We must apply a small variation of the kernel method due to the perturbation introduced by $P_0^{\geq}(u)$, compare the functional equation (50). The most important formula in this section is Formula (48).

Theorem 4.1.5 (Generating function for meanders and excursions). *The bivariate generating function of meanders (where z marks size and u marks final altitude) in the reflection-absorption model is algebraic:*

$$F(z, u) = \frac{1 - z \sum_{k=0}^{c-1} r_k(u) F_k(z)}{1 - zP(u)}, \quad (47)$$

where r_k is a Laurent polynomial given by $r_k(u) = \sum_{j=-c}^{-k-1} p_j u^{j+k}$ for $k > 0$ and $r_0(u) = P(u) - P_0^{\geq}(u)$. Furthermore, the F_k 's are algebraic functions belonging to $\mathbb{Q}(u_1, \dots, u_c, p_{-c}, \dots, p_d, p_{0,0}, \dots, p_{0,d}, z)$, where the u_i 's are the roots of the kernel equation $1 - zP(u) = 0$, such that $\lim_{z \rightarrow 0} u_i(z) = 0$. The F_k 's can be made explicit, e.g. the generating function of excursions is

$$F_0(z) = \frac{1}{1 - z \left(\sum_{\ell=1}^c u_{\ell}^{c-1} P_0^{\geq}(u_{\ell}) / V(\ell) \right)}, \quad (48)$$

where $V(\ell) = \prod_{\substack{i=1 \\ i \neq \ell}}^c (u_{\ell} - u_i)$ is a Vandermonde-like product.

Proof. We are going to give the subsequent proof in several steps.

- Functional equation:

It is straightforward to derive a recurrence relation, by a step-by-step approach:

$$\begin{aligned} f_0(u) &= 1, \\ f_{n+1}(u) &= \{u^{\geq 0}\} [P(u)\{u^{>0}\}f_n(u) + P_0(u)\{u^0\}f_n(u)], \end{aligned}$$

where $\{u^{\geq 0}\}$ is the linear operator extracting all terms in the power series representation containing non-negative powers of

u . Multiplying by z^{n+1} and summing over all $n \geq 0$ we derive the following functional equation

$$\begin{aligned} F(z, u) - 1 &= zP(u)F(z, u) - zP(u)F_0(z) + zP_0^\geq(u)F_0(z), \\ &\quad - z\{u^{<0}\} [P(u)\{u^{>0}\}F(z, u)] \\ &= zP(u)F(z, u) - z\left(P(u) - P_0^\geq(u)\right)F_0(z) \\ &\quad - z\sum_{k \geq 1} F_k(z)\{u^{<0}\}(P(u)u^k), \end{aligned} \quad (49)$$

and we get

$$\begin{aligned} F(z, u)K(z, u) &= 1 - z\left(P(u) - P_0^\geq(u)\right)F_0(z) \\ &\quad - z\sum_{k=1}^{c-1} r_k(u)F_k(z), \end{aligned} \quad (50)$$

$$K(z, u) = 1 - zP(u), \quad (51)$$

where $K(z, u)$ is called the *kernel* of the equation and the $r_k(u)$, $k = 1, \dots, c-1$, are some Laurent polynomials that are computable from (49) (see also [19, p. 49]):

$$r_k(u) := \{u^{<0}\}(P(u)u^k) = \sum_{j=-c}^{-k-1} p_j u^{j+k}.$$

This shows the algebraic character of $F(z, u)$ and gives (47).

- Kernel method:

From the theory of Newton–Puiseux expansions, the fundamental result in the theory of algebraic curves [1, 143], we know that the kernel equation from Definition 1.3.3

$$1 - zP(u) = 0, \quad (52)$$

has $c + d$ distinct solutions in u , with c of them being called “small branches”, as they map 0 to 0 and are in modulus smaller than the other d “large branches” which grow in modulus to infinity while approaching 0. We call the small branches u_1, \dots, u_c and the large ones v_1, \dots, v_d . We sometimes also denote the large ones as u_{c+1}, \dots, u_{c+d} as they result from an equation of degree $c + d$. Inserting the c small branches into (50) we get a linear system of c equations in the c unknowns F_0, \dots, F_{c-1} :

$$\begin{cases} u_1^c - z\sum_{k=0}^{c-1} u_1^c r_k(u_1)F_k(z) &= 0, \\ \vdots & \\ u_c^c - z\sum_{k=0}^{c-1} u_c^c r_k(u_c)F_k(z) &= 0. \end{cases} \quad (53)$$

In order to unify the notation we define $r_0(u) := P(u) - P_0^\geq(u)$. We will see in the subsequent discussion that this system is

non-singular as it is a variant of the Vandermonde determinant, and as the small branches are clearly all distinct. Note that this system is closely related to the one solved in the proof of [19, Theorem 2]. The difference is the perturbation introduced by $r_0(u_i)$ in the first column.

- Solution of the linear system:

The general strategy is to apply Cramer's rule to make the F_k 's explicit. The corresponding matrix equation reads

$$\underbrace{\begin{pmatrix} zu_1^c r_0(u_1) & zu_1^c r_1(u_1) & \dots & zu_1^c r_{c-1}(u_1) \\ \vdots & \vdots & \ddots & \vdots \\ zu_c^c r_0(u_c) & zu_c^c r_1(u_c) & \dots & zu_c^c r_{c-1}(u_c) \end{pmatrix}}_{=:M} \begin{pmatrix} F_0 \\ \vdots \\ F_{c-1} \end{pmatrix} = \begin{pmatrix} u_1^c \\ \vdots \\ u_c^c \end{pmatrix}. \quad (54)$$

By Cramer's rule [91] the solution is given by

$$F_i = \frac{\det(M_i)}{\det(M)}, \quad i = 0, \dots, c-1, \quad (55)$$

where M_i is formed from M by replacing the $(i+1)$ -th column by the column vector $(u_i^c)_{i=1}^c$. The key to solve these determinants is to notice the Vandermonde-like character when considering all but the first column. We compute these "nice" matrices by Laplace expansion (also known as cofactor expansion [91]) with respect to the first column.

- Vandermonde-like structures and $\det(M)$:

Let us start with the denominator

$$\det(M) = \sum_{\ell=1}^c (-1)^{\ell+1} zu_\ell^c r_0(u_\ell) \cdot \mu_{\ell,1}, \quad (56)$$

where $\mu_{i,j}$ is called a *minor* and defined to be the determinant of the $(c-1) \times (c-1)$ -matrix that results from M by removing the i -th row and j -th column. The ones associated with the first column possess the following structure (in the sequel we denote the determinant by $|\cdot|$ -brackets):

$$\mu_{\ell,1} = \begin{vmatrix} zu_1^c r_1(u_1) & \dots & zu_1^c r_{c-1}(u_1) \\ \vdots & & \vdots \\ zu_{\ell-1}^c r_1(u_{\ell-1}) & \dots & zu_{\ell-1}^c r_{c-1}(u_{\ell-1}) \\ zu_{\ell+1}^c r_1(u_{\ell+1}) & \dots & zu_{\ell+1}^c r_{c-1}(u_{\ell+1}) \\ \vdots & & \vdots \\ zu_c^c r_1(u_c) & \dots & zu_c^c r_{c-1}(u_c) \end{vmatrix}.$$

Next we investigate the repeatedly occurring term $zu_i^c r_k(u_i)$. For $k = 0$ it can be simplified by the kernel equation (52):

$$zu_i^c r_0(u_i) = u_i^c \left(1 - zP_0^\geq(u_i)\right). \quad (57)$$

For $k = 1, \dots, c-1$ the term $u_i^c r_k(u_i)$ can be written as:

$$u_i^c r_k(u_i) = \sum_{j=-c}^{-k-1} p_j u_i^{j+k+c} = \sum_{j=0}^{c-k-1} p_{-c+j} u_i^{j+k} = \sum_{j=k}^{c-1} p_{-c-k+j} u_i^j. \quad (58)$$

The last expressions shows that this polynomial is always of degree $c-1$ and we see that the k -th such expression consists exactly of $c-k$ terms. Note in particular that $u_i^c r_{c-1}(u_i) = p_{-c} u_i^{c-1}$. All following determinant computations are performed for $z \in (0, \rho)$. In order to ease notation we restrict ourselves to $\mu_{1,1}$, all other minors are dealt with in the same manner. We start by the extraction of z from every column and u_i from every row to get

$$\mu_{1,1} = z^{c-1} \left(\prod_{j=2}^c u_j \right) \begin{vmatrix} u_2^{c-1} r_1(u_2) & \dots & u_2^{c-1} r_{c-2}(u_2) & p_{-c} u_2^{c-2} \\ \vdots & & \vdots & \vdots \\ u_c^{c-1} r_1(u_c) & \dots & u_c^{c-1} r_{c-2}(u_c) & p_{-c} u_c^{c-2} \end{vmatrix}.$$

Extracting p_{-c} from the last column a Vandermonde-like structure starts to appear. For the next to last column we have from (58) the explicit form $u_i^{c-1} r_{c-2}(u_i) = p_{-c} u_i^{c-3} + p_{-c+1} u_i^{c-2}$. Hence subtracting the last column multiplied by p_{-c+1} yields

$$\mu_{1,1} = p_{-c}^2 z^{c-1} \left(\prod_{j=2}^c u_j \right) \times \begin{vmatrix} u_2^{c-1} r_1(u_2) & \dots & p_{-c} u_2^{c-4} + p_{-c+1} u_2^{c-3} + p_{-c+2} u_2^{c-2} & u_2^{c-3} & u_2^{c-2} \\ \vdots & & \vdots & \vdots & \vdots \\ u_c^{c-1} r_1(u_c) & \dots & p_{-c} u_c^{c-4} + p_{-c+1} u_c^{c-3} + p_{-c+2} u_c^{c-2} & u_c^{c-3} & u_c^{c-2} \end{vmatrix}.$$

We used (58) again, to get the explicit structure of $u_i^{c-1} r_{c-3}(u_i)$. Now we proceed in the same way for every column from right to left and reveal the Vandermonde shape:

$$\begin{aligned} \mu_{1,1} &= (zp_{-c})^{c-1} \left(\prod_{j=2}^c u_j \right) \begin{vmatrix} 1 & u_2 & \dots & u_2^{c-2} \\ \vdots & \vdots & & \vdots \\ 1 & u_c & \dots & u_c^{c-2} \end{vmatrix} \\ &= (zp_{-c})^{c-1} \left(\prod_{j=2}^c u_j \right) \prod_{2 \leq m < n \leq c} (u_n - u_m). \end{aligned}$$

As a shorthand we define the *partial Vandermonde products*

$$\widehat{V}(\ell) := \prod_{\substack{1 \leq m < n \leq c \\ m \neq \ell, n \neq \ell}} (u_n - u_m), \quad V(\ell) := \prod_{\substack{i=1 \\ i \neq \ell}}^c (u_\ell - u_i). \quad (59)$$

Note that these factors are part of a Vandermonde determinant $V_c := \prod_{m < n} (u_n - u_m)$. In particular, we have

$$\widehat{V}(\ell)V(\ell) = (-1)^{\ell+c}V_c. \quad (60)$$

Mimicking the above process for a general minor $\mu_{\ell,1}$ yields

$$\mu_{\ell,1} = (zp_{-c})^{c-1} \widehat{V}(\ell) \prod_{\substack{j=1 \\ j \neq \ell}}^c u_j, \quad (61)$$

and we get for (56) combined with (57)

$$\begin{aligned} \det(M) &= (zp_{-c})^{c-1} \sum_{\ell=1}^c (-1)^{\ell+1} u_\ell^c \left(1 - zP_0^\geq(u_\ell)\right) \cdot \widehat{V}(\ell) \prod_{\substack{j=1 \\ j \neq \ell}}^c u_j \\ &= (zp_{-c})^{c-1} \left(\prod_{j=1}^c u_j\right) \sum_{\ell=1}^c (-1)^{\ell+1} u_\ell^{c-1} \left(1 - zP_0^\geq(u_\ell)\right) \widehat{V}(\ell). \end{aligned} \quad (62)$$

- Generating function for excursions:

As a second step we investigate $\det(M_0)$ in order to derive an explicit formula for F_0 . In this determinant the perturbation caused by r_0 in the first column is replaced by a new one, created from the right-hand side of the linear system (54):

$$\det(M_0) = \begin{vmatrix} u_1^c & zu_1^c r_1(u_1) & \dots & zu_1^c r_{c-1}(u_1) \\ \vdots & \vdots & \ddots & \vdots \\ u_c^c & zu_c^c r_1(u_c) & \dots & zu_c^c r_{c-1}(u_c) \end{vmatrix}.$$

From (58) we know that all polynomials $u_i^c r_j(u_i)$ are of order $c-1$. The idea to evaluate this determinant is now the same as above for $\det(M)$. Firstly, expand the determinant with respect to the first column:

$$\det(M_0) = \sum_{\ell=1}^c (-1)^{\ell+1} u_\ell^c \cdot \mu_{\ell,1}.$$

Secondly, use (61) to get an explicit formula that closely resembles (62):

$$\det(M_0) = (zp_{-c})^{c-1} \left(\prod_{j=1}^c u_j\right) \underbrace{\sum_{\ell=1}^c (-1)^{\ell+1} u_\ell^{c-1} \widehat{V}(\ell)}_{=(-1)^{c+1}V_c}.$$

The simplification of the last sum is possible due to (59), as we recognize the Laplace expansion of a Vandermonde determinant with respect to the last column $(u_\ell^{c-1})_{\ell=1\dots c}$. Note that we can use the same simplification in $\det(M)$. Thus, the probability generating function of excursions is given by

$$\begin{aligned} F_0(z) &= \frac{\det(M_0)}{\det(M)} = \frac{(-1)^{c+1}V_c}{\sum_{\ell=1}^c (-1)^{\ell+1}u_\ell^{c-1} \left(1 - zP_0^\geq(u_\ell)\right) \cdot \widehat{V}(\ell)} \\ &= \frac{1}{1 - z \left(\sum_{\ell=1}^c u_\ell^{c-1}P_0^\geq(u_\ell)/V(\ell)\right)}. \end{aligned} \quad (63)$$

For the last representation we used (60).

- Algebraicity of GFs for meanders ending at altitude $k < c$:

The generating function for meanders of height $k < c$ is given by $F_k(z)$. The same techniques as used for computing $F_0(z)$ lead to explicit representation in terms of Vandermonde-like determinants in the small branches $u_i(z)$. These computations are more involved, because two perturbations are present in the determinants. However, all these functions are constructed from the algebraic functions $u_i(z)$ by standard algebraic operations, like multiplication, division and addition. Therefore, they are algebraic, as algebraic functions are closed under these operations.

This proves the claim. □

The following section treats the case of meanders ending at altitude k and derives their general structure.

Generating functions for meanders ending at altitude k

In the following we will encounter two famous families of symmetric polynomials: complete homogeneous symmetric polynomials h_k and Schur polynomials s_λ . They were introduced in Section 2.4.

Lemma 2.4.5 will help us to show how the general Formula (48) for excursions simplifies in the case of the Banderier-Flajolet model and yields the known representation $\widetilde{E}(z) = (-1)^{c+1}(\prod u_i(z))/(zp_{-c})$. (Recall that for the generating function of excursions in the Banderier-Flajolet model we use the notation $\widetilde{E}(z)$.) For more details see [19, Equation (20)] and Section 1.6. Note that this model is a special case of the absorption model with $P_0(u) = P(u)$. In this special case we get from the kernel equation (52)

$$zP^\geq(u_\ell) = 1 - \sum_{i=1}^c \frac{zp_{-i}}{u_\ell^i}.$$

Next, we change the order of summation in the denominator of (48) to get

$$F_0(z) = \frac{1}{1 - \sum_{\ell=1}^c u_\ell^{c-1}/V(\ell) + z \sum_{i=1}^c z p_{-i} \sum_{\ell=1}^c u_\ell^{c-i-1}/V(\ell)}.$$

The sums in the denominator possess a neat simplification given by the following

Lemma 4.1.6. *Let $u_i(z)$ for $i = 1, \dots, c$ be the small branches of the kernel equation $1 - zP(u) = 0$, and let $V(\ell) = \prod_{\substack{i=1 \\ i \neq \ell}}^c (u_\ell - u_i)$ be a partial Vandermonde product. Then*

$$\sum_{\ell=1}^c \frac{u_\ell^k}{V(\ell)} = \begin{cases} (-1)^{c+1} / \prod_{i=1}^c u_i, & \text{for } k = -1, \\ 0, & \text{for } 0 \leq k \leq c-2, \\ h_{k-c+1}(u_1, \dots, u_c), & \text{for } k \geq c-1. \end{cases}$$

Proof. From (59) we know for the partial Vandermonde products that $V(\ell)\widehat{V}(\ell) = (-1)^{\ell+c}V_c$. These sums arise from (singular) matrices which were expanded using Laplace expansion. In the case $k = -1$ we get $(-1)^{c+1}/V_c \sum_{\ell=1}^c (-1)^{\ell+1}u_\ell^{-1}\widehat{V}(\ell)$ where the sum can be interpreted as

$$\begin{vmatrix} u_1^{-1} & 1 & u_1 & \dots & u_1^{c-2} \\ \vdots & \vdots & \vdots & & \vdots \\ u_c^{-1} & 1 & u_c & \dots & u_c^{c-2} \end{vmatrix} = \frac{1}{\prod u_i} \begin{vmatrix} 1 & u_1 & u_1^2 & \dots & u_1^{c-1} \\ \vdots & \vdots & \vdots & & \vdots \\ 1 & u_c & u_c^2 & \dots & u_c^{c-1} \end{vmatrix} = \frac{V_c}{\prod u_i}. \quad (64)$$

In the cases $0 \leq k \leq c-2$ and $k \geq c-1$ we interpret them as determinants of matrices which were expanded with respect to the last column. Then for $0 \leq k \leq c-2$ they are singular because two columns are the same. However, for $k \geq c-1$ the following determinant is defining a certain class of Schur polynomials $s_{(k,0,\dots,0)}(u_1, \dots, u_c)$. In particular we get for $k \geq 0$

$$\frac{1}{V_c} \begin{vmatrix} 1 & u_1 & \dots & u_1^{c-2} & u_1^k \\ \vdots & \vdots & \vdots & & \vdots \\ 1 & u_c & \dots & u_c^{c-2} & u_c^k \end{vmatrix} = \begin{cases} 0, & k \leq c-2, \\ s_{(k-c+1,0,\dots,0)}(u_1, \dots, u_c), & k \geq c-1. \end{cases} \quad (65)$$

For more details on the determinant compare with $\mu_{1,1}$ from the previous proof. Finally, Lemma 2.4.5 yields the result. \square

Remark 10. Lemma 4.1.6 is a generalization of the well-known factorization formula

$$\frac{u_1^{k+1} - u_2^{k+1}}{u_1 - u_2} = u_1^k + u_1^{k-1}u_2 + \dots + u_1u_2^{k-1} + u_2^k.$$

This formula arises for $c = 2$. For arbitrary c it could also be stated as

$$h_k(u_1, \dots, u_c) = \sum_{i=0}^c \frac{u_i^{k+c-1}}{\prod_{j \neq i} (u_i - u_j)},$$

which closer resembles the known expression.

Thus, applying the cases $k = -1, \dots, c - 1$ of the previous lemma we derive the known representation of the Banderier-Flajolet-model

$$F_0(z) = \frac{(-1)^{c+1} \prod_{i=1}^c u_i}{z p_{-c}} = \tilde{E}(z). \tag{66}$$

Lemma 4.1.6 can also be used to get a different representation of $F_0(z)$ in the general case:

Corollary 4.1.7. *The generating function of excursions is given by*

$$E(z) := F_0(z) = \frac{1}{1 - z \sum_{i=0}^{d_0} p_{0,i} h_i(u_1, \dots, u_c)}, \tag{67}$$

where the $h_i(x_1, \dots, x_c)$ are the complete homogeneous symmetric polynomials of degree i in c unknowns.

Proof. Rewriting the sum in the denominator of (48) gives

$$\sum_{\ell=1}^c \frac{u_\ell^{c-1} P_0^{\geq}(u_\ell)}{V(\ell)} = \sum_{i=0}^{d_0} p_{0,i} \sum_{\ell=1}^c \frac{u_\ell^{c+i-1}}{V(\ell)} = \sum_{i=0}^{d_0} p_{0,i} h_i(u_1, \dots, u_c),$$

where we applied the results for $k \geq c - 1$ of Lemma 4.1.6 in the last equality. \square

Using this result we are able to derive the general formula for $F_k(z)$. We start with a combinatorial interpretation of (67) using the following subclass of excursions.

An *arch* is defined as an excursion of size > 0 whose only contact with the x -axis is at its end points. We denote this set by \mathcal{A} . Every excursion, denoted by the set \mathcal{E} , consists of a sequence of arches, i.e. $\mathcal{E} = \text{SEQ}(\mathcal{A})$. The symbolic method (see e.g. [85]) directly provides the functional equation

$$E(z) = \frac{1}{1 - A(z)}, \tag{68}$$

which is easily solved to give the generating function of arches

$$A(z) = 1 - \frac{1}{E(z)} = z \sum_{i=0}^{d_0} p_{0,i} h_i(u_1, \dots, u_c). \tag{69}$$

Each summand in (69) can be interpreted independently. We define *arches with excess* $i \geq 0$ as simple paths starting at altitude i and ending on the x -axis while staying always strictly above the x -axis, except for their endpoint. We denote their generating function by $A_i(z)$. Obviously, $A_0(z) = 1$ holds, as all arches of positive length touch the x -axis twice.

Corollary 4.1.8. *The generating function of arches with excess i is equal to*

$$A_i(z) = h_i(u_1, \dots, u_c).$$

Proof. Formula (69) implies that an arch starts with a jump $+i$ and is followed by a path counted by $h_i(u_1, \dots, u_c)$. So the path starts at altitude $i \geq 0$, ends at altitude 0 and is always strictly above the x -axis; thus an arch with excess i . \square

Let us denote the generating functions of meanders terminating at altitude k from the Banderier-Flajolet-model by $\tilde{F}_k(z)$. We arrive at the final

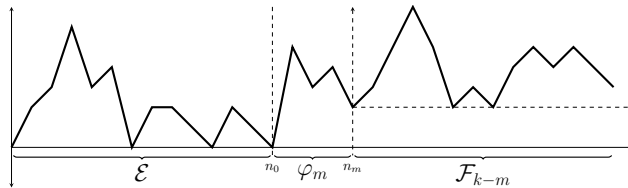

Figure 18: Decomposition of a meander terminating at altitude k from Theorem 4.1.9.

Theorem 4.1.9. *The generating function of meanders terminating at altitude $k > 0$ is*

$$F_k(z) = zE(z) \sum_{m=1}^{\min(k, d_0)} \left(\sum_{\ell=m}^{d_0} p_{0, \ell} h_{\ell-m}(u_1, \dots, u_c) \right) \tilde{F}_{k-m}(z). \quad (70)$$

Proof. A meander of length n ending at altitude $k > 0$ decomposes uniquely into three parts, see Figure 18. Firstly, observe that after n_0 steps it touches the x -axis for the last time. The part from 0 to n_0 is a meander \mathcal{E} counted by $E(z)$. Secondly, consider the walk starting from n_0 and let $0 < m \leq k$ be the unique minimal altitude of any vertex after n_0 steps. Thus, there exists a unique point $n_m > n_0$ where the walk reaches the altitude m for the first time. Let φ_m be the walk from n_0 to n_m . Thirdly, the walk from n_m to n is a meander \mathcal{F}_{k-m} of the Banderier-Flajolet-model terminating at altitude $k - m$ and thus counted by $\tilde{F}_{k-m}(z)$.

The walk φ_m starts with a jump from the x -axis to altitude $\ell \geq m$, as m is the minimal altitude for all later points. This part is represented by $p_{0, \ell} z$. Then, n_m is the first point where altitude m is reached and therefore the path from $n_0 + 1$ to n_m is an arch with excess $\ell - m$ counted by $A_{\ell-m}(z)$. \square

Example 4.1.10 (Generating function for meanders terminating at altitude 1). The techniques used in the proof of Theorem 4.1.5 can also be used to directly derive the formulae for $F_k(z)$. However, they are much more complicated and hide a lot of structure compared to the

approach over the complete symmetric homogeneous polynomials $h_k(u_1, \dots, u_c)$.

The techniques which have been used applied determinant manipulations in order to reveal Vandermonde matrices. Continuing the process of the proof we need to deal with a second perturbation in order to compute $\det(M_1)$. This can be done by a second application of Lagrange inversion, and after tedious calculations one gets

$$\det(M_1) = (zp_{-c})^{c-2} \left(\prod_{j=1}^c u_j^2 \right) \sum_{j=1}^c (-1)^{j+1} u_j^{c-2} z r_0(u_j) \widehat{V}(j).$$

By (55) and (57) we get

$$\begin{aligned} F_1(z) &= \frac{(-1)^c (\prod_{j=1}^c u_j) \sum_{j=1}^c (-1)^{j+1} u_j^{c-2} (1 - zP_0^{\geq}(u_j)) \widehat{V}(j)}{zp_{-c} \sum_{j=1}^c (-1)^{j+1} u_j^{c-1} (1 - zP_0^{\geq}(u_j)) \widehat{V}(j)} \\ &= zE(z) \widetilde{E}(z) \left(\sum_{j=1}^c u_j^{c-2} P_0^{\geq 1}(u_j) / V(j) \right). \end{aligned} \quad (71)$$

For the first equality we used $(-1)^{\lfloor \frac{c-2}{2} \rfloor} / (-1)^{\lfloor \frac{c-1}{2} \rfloor} = (-1)^c$. For the second equality we used the fact that the sum in the numerator vanishes if $k \leq c-2$ in the coefficient u_j^k , compare (65), and the same ideas as in (63) coming from (59). Here we introduce $P_0^{\geq 1}(u) := \sum_{i=1}^{d_0} p_{0,i} u^i$.

An application of Lemma 4.1.6 gives the known representation (70) in terms of complete homogeneous symmetric polynomials:

$$F_1(z) = zE(z) \widetilde{E}(z) \sum_{i=1}^{d_0} p_{0,i} h_{i-1}(u_1, \dots, u_c).$$

This formula also holds for $c = 1$, as this case can be interpreted as a special instance of $c = 2$, with $p_{-2} = 0$. All computations are legitimate as there is no division by p_{-2} .

Finally, note that for $c = 1$ we know that $\widetilde{E}(z) = u_1(z)/(zp_{-1})$ and (71) simplifies to

$$F_1(z) = E(z) \frac{P_0^{\geq 1}(u_1(z))}{p_{-1}} = E(z) \frac{zP_0^{\geq 1}(\widetilde{E}(z)zp_{-1})}{zp_{-1}}.$$

The last expression admits a combinatorial interpretation: A meander of altitude 1 starts with an excursion which is followed by an arbitrary jump of positive altitude $k > 0$. This jump is compensated by k excursions in the Banderier-Flajolet-model which are themselves followed by $k-1$ jumps of size -1 in order to reach altitude 1. In the following sections we will focus on this case of $c = 1$ and analyze it in full detail from a probabilistic, a combinatorial and an analytic point of view.

4.2 ŁUKASIEWICZ WALKS AND EXCURSIONS

From now on, we are going to work with *aperiodic Łukasiewicz paths*. By these we understand paths with one jump of size -1 and finitely but arbitrarily many positive jumps. Hence, the jump polynomial of Łukasiewicz paths is given by

$$P(u) = p_{-1}u^{-1} + p_0 + p_1u + \dots + p_du^d,$$

with $p_{-1} + \dots + p_d = 1$, $p_i \in [0, 1]$, and $p_{-1} \neq 0$, $p_d \neq 0$.

Generating function of excursions

Since $c = 1$ the linear system in (53) consists of only one equation, to wit

$$u_1 + zu_1 \left(P_0^{\geq}(u_1) - P(u_1) \right) F_0(z) = 0.$$

We use the kernel equation $1 - zP(u) = 0$, which holds for the small branch u_1 to derive the generating function of excursions

$$E(z) := \sum_{n \geq 0} e_n z^n := F_0(z) = \frac{1}{1 - zP_0^{\geq}(u_1(z))}. \tag{72}$$

If you pick a random walk of fixed length n , the coefficient e_n represents the probability that this walk is an excursion. In this spirit $E(z)$ is the generating function for the ratio of excursions among all walks.

This nice formula has a natural combinatorial interpretation as $\text{SEQ} \left(zP_0^{\geq} \left(\tilde{E}(z)p_{-1}z \right) \right)$, i.e. an excursion (in the reflection-absorption model) is a sequence of arches (i.e. an excursion touching 0 just at its two ends), and each arch begins with a positive jump $+k$, which has to be compensated by k excursions (strictly speaking, shifted excursions: from altitude j to altitude j , for j from 1 to k , thus not touching 0, and thus in bijection with excursions, counted by $\tilde{E}(z)$ and defined in (66)) followed each by a negative jump -1 .

Asymptotics

In [19, Equation (42)] it was shown that the principal branch $u_1(z)$ possesses the following asymptotic expansion for $z \rightarrow \rho^-$, where ρ is the *structural radius* defined as $\rho = \frac{1}{P(\tau)}$ and $\tau > 0$ is called the *structural constant* defined as the unique positive root of $P'(\tau) = 0$ (note that P is a convex function): For $z \rightarrow \rho^-$ we have

$$u_1(z) = \tau - \sqrt{2 \frac{P(\tau)}{P''(\tau)}} \sqrt{1 - z/\rho} + \mathcal{O}(1 - z/\rho). \tag{73}$$

As this expansion will appear repeatedly in the sequel we define $C := \sqrt{2 \frac{P(\tau)}{P''(\tau)}}$. The singularities of (72) depend on the roots of the denominator and on the singular behavior of $u_1(z)$ which are treated in the following

Lemma 4.2.1 (Singularity of the denominator). *Let $u_1(z)$ be the unique small branch of the kernel equation $1 - zP(u) = 0$. Then the equation $1 - zP_0^\geq(u_1(z)) = 0$ has at most one solution in $z \in (0, \rho]$, which we denote by ρ_1 .*

Proof. In [19] the authors show that $u_1(z)$ is monotonically increasing on $[0, \rho)$ and gets singular at ρ as its first derivative does not exist. Furthermore, it is shown that at the singularity $z = \rho$ the function attains the finite value $u_1(\rho) = \tau$. The polynomial $P_0^\geq(u)$ has only positive coefficients, which directly implies that it is also monotonically increasing on $[0, \rho]$. Note that $z = 0$ cannot be a solution as $P_0^\geq(u)$ is bounded. Rearranging the equation gives

$$P_0^\geq(u_1(z)) = \frac{1}{z}, \quad \text{for } z \in (0, \rho]. \quad (74)$$

As the right-hand side is monotonically increasing but the left-hand side is monotonically decreasing on $(0, \rho]$, the claim follows. \square

Figure 19 shows the three possible configurations. The naming convention is adopted from its use in functional composition schemes in [85, Chapter VI.9]. On $[0, \rho]$ the maximum of the left-hand side in (74) is $P_0^\geq(\tau)$ which is attained at ρ whereas the minimum of the right-hand side is $1/\rho = P(\tau)$. If $P(\tau) \leq P_0^\geq(\tau)$ it follows from Lemma 4.2.1 that there exists a unique value ρ_1 where they intersect, whereas for $P(\tau) > P_0^\geq(\tau)$ such a value cannot exist. Note that this is also a consequence of the intermediate value theorem, as all involved functions are continuous.

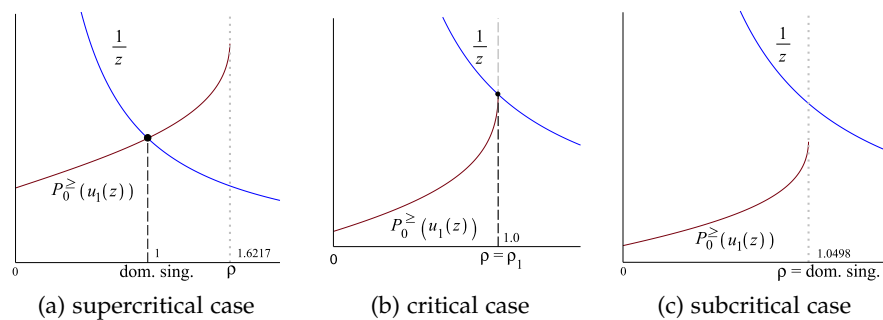

Figure 19: Different singular behaviors of the generating function of excursions. The increasing function represents $P_0^\geq(u_1(z))$ where the decreasing function is $1/z$. The dominant singularity is either located at the intersection or at ρ .

Theorem 4.2.2 (Asymptotics of excursions). *Let τ be the structural constant determined by $P'(\tau) = 0$, $\tau > 0$, let $\rho = 1/P(\tau)$ be the structural radius and ρ_1 defined as in Lemma 4.2.1. Define the constants $\alpha = (P_0^\geq(u_1(z)))' \Big|_{z=\rho_1}$, $\gamma = \frac{1}{\alpha\rho_1^2+1}$, and $\kappa = C\rho(P_0^\geq)'(\tau)$. The excursions in the reflection-absorption model possess the following asymptotic expansion:*

$$E(z) = \begin{cases} \gamma(1 - z/\rho_1)^{-1} + \mathcal{O}(1), & \text{supercr. case: } P(\tau) < P_0^\geq(\tau), \\ \frac{1}{\kappa}(1 - z/\rho)^{-1/2} + \mathcal{O}(1), & \text{critical case: } P(\tau) = P_0^\geq(\tau), \\ E(\rho) - E(\rho)^2\kappa(1 - z/\rho)^{1/2} \\ + \mathcal{O}(1 - z/\rho), & \text{subcr. case: } P(\tau) > P_0^\geq(\tau). \end{cases} \quad (75)$$

Remark 11. Defining $\rho_0^\geq = 1/P_0^\geq(\tau)$ as the structural reflection radius the previous statements can also be formulated in terms of the structural radii ρ and ρ_0^\geq . By doing so the inequality signs which characterize the critical behavior flip.

Proof. We are going to apply singularity analysis to extract the asymptotic behavior of $E(z)$. The main idea is to expand $E(z)$ in a small vicinity of the dominant singularity into standard functions whose asymptotic expansions are known, see e.g. [85, Figure VI.5]. From (72) we deduce that there are three different cases which we have to distinguish (compare Figure 19).

(a) *Supercritical case: $P(\tau) < P_0^\geq(\tau)$*

In the supercritical case the denominator gets 0 before $u_1(z)$ gets singular which implies $\rho_1 < \rho$. Hence, $u_1(z)$ is regular at ρ_1 . For the remainder of this case we fix a small neighborhood of ρ_1 denoted by $z \sim \rho_1$ where all subsequent expansions are performed in. Then, $u_1(z)$ possesses the following Taylor expansion at ρ_1 :

$$u_1(z) = u_1(\rho_1) + u_1'(\rho_1)(z - \rho_1) + \mathcal{O}((z - \rho_1)^2).$$

Using this expansion we get

$$P_0^\geq(u_1(z)) = \underbrace{P_0^\geq(u_1(\rho_1))}_{=1/\rho_1} + \underbrace{(P_0^\geq(u_1(z)))' \Big|_{z=\rho_1}}_{=: \alpha} (z - \rho_1) + \mathcal{O}((z - \rho_1)^2).$$

Hence, the denominator of (72) has the following asymptotic expansion

$$1 - zP(u_1(z)) = (1 + \alpha\rho_1^2) \left(1 - \frac{z}{\rho_1}\right) + \mathcal{O}((1 - z/\rho_1)^2).$$

For brevity we introduce the constant $\gamma := 1/(\alpha\rho_1^2 + 1)$, which will appear repeatedly in the subsequent discussion. Note that

we have $\gamma > 0$ because of $\alpha \geq 0$. This yields the asymptotic expansion

$$E(z) = \frac{\gamma}{1 - z/\rho_1} + \mathcal{O}(1 - z/\rho_1). \quad (76)$$

(b) *Critical case:* $P(\tau) = P_0^\geq(\tau)$

In the critical case both singularities coincide with each other, i.e. $\rho_1 = \rho$. Hence, using (73) we derive

$$\begin{aligned} E(z) &= \frac{1}{1 - zP_0^\geq(\tau - C\sqrt{1 - z/\rho} + \mathcal{O}(1 - z/\rho))} \\ &= \frac{1}{1 - \rho \underbrace{P_0^\geq(\tau)}_{=1/\rho} + \rho \underbrace{C(P_0^\geq)'(\tau)}_{=: \kappa} \sqrt{1 - z/\rho} + \mathcal{O}(1 - z/\rho)} \\ &= \frac{1}{\kappa \sqrt{1 - z/\rho} (1 + \mathcal{O}(\sqrt{1 - z/\rho}))} \\ &= \frac{1}{\kappa \sqrt{1 - z/\rho}} + \mathcal{O}(\sqrt{1 - z/\rho}), \end{aligned} \quad (77)$$

with $\kappa := C\rho(P_0^\geq)'(\tau)$. This constant will also appear repeatedly in the ongoing discussion. For the asymptotic expansion in the second line we used that $P_0^\geq(u)$ is regular at τ as it is a polynomial.

(c) *Subcritical case:* $P(\tau) > P_0^\geq(\tau)$

In the subcritical case the singularity of $u_1(z)$ is responsible for the singularity of $E(z)$, as by Lemma 4.2.1 the denominator of (72) remains strictly positive on $[0, \rho)$. Therefore the asymptotic expansion is easily derived from (73) as:

$$\begin{aligned} E(z) &= \frac{1}{1 - zP_0^\geq(\tau - C\sqrt{1 - z/\rho} + \mathcal{O}(1 - z/\rho))} \\ &= \frac{1}{1 - \rho P_0^\geq(\tau) + \kappa \sqrt{1 - z/\rho} + \mathcal{O}(1 - z/\rho)}. \end{aligned}$$

In the first line we applied a Taylor series expansion to $P_0^\geq(u)$ at $u = \tau$. As a next step we use that $E(\rho) = 1/(1 - \rho P_0^\geq(\tau))$ and get

$$\begin{aligned} &= \frac{E(\rho)}{1 + \kappa E(\rho) \sqrt{1 - z/\rho} + \mathcal{O}(1 - z/\rho)} \\ &= E(\rho) - E(\rho)^2 \kappa \sqrt{1 - z/\rho} + \mathcal{O}(1 - z/\rho). \end{aligned} \quad (78)$$

This proves all possible cases. \square

From the asymptotic expansions in Theorem 4.2.2 it is straightforward to get the following

Corollary 4.2.3. *Let $\varepsilon > 0$. The asymptotic expansions of the coefficients $e_n = [z^n]E(z)$ are*

$$e_n = \begin{cases} \gamma\rho_1^{-n} + \mathcal{O}((\rho_1 + \varepsilon)^{-n}), & \text{supercr. case: } P(\tau) < P_0^\geq(\tau), \\ \frac{1}{\kappa} \frac{\rho^{-n}}{\sqrt{\pi n}} \left(1 + \mathcal{O}\left(\frac{1}{n}\right)\right), & \text{critical case: } P(\tau) = P_0^\geq(\tau), \\ E(\rho)^2 \frac{\kappa}{2} \frac{\rho^{-n}}{\sqrt{\pi n^3}} \left(1 + \mathcal{O}\left(\frac{1}{n}\right)\right), & \text{subcr. case: } P(\tau) > P_0^\geq(\tau). \end{cases} \quad (79)$$

Remark 12. When interpreting the asymptotics of e_n one has to recall that $E(z)$ is in general no probability generating function. The weights e_n are to be interpreted with respect to the probability space of *all* possible walks (compare Definition 4.1.4). A normalization by the ratio of meanders, derived in Section 4.4 would give the corresponding probability generating function.

However, in the case of the reflection model $E(z)$ is the probability generating function of the model, because there are no paths that would go below the x -axis.

Remark 13. The reflection-absorption model of Banderier-Flajolet is a special case of the subcritical case. This model is defined by $P_0(u) = P(u)$. Hence, we get

$$P(u) = p_{-c}u^{-c} + \dots + p_{-1}u^{-1} + \underbrace{p_0 + p_1u + \dots + p_du^d}_{=P_0^\geq(u)},$$

with $p_{-c} \neq 0$ and $p_d \neq 0$. Therefore, independent on the value of τ we always have $P(\tau) > P_0^\geq(\tau)$.

Limit laws for the number of returns to zero of excursions

Recall that an *arch* is defined as an excursion of size > 0 whose only contact with the x -axis is at its end points. An excursion is naturally decomposed into a sequence of arches, as seen in (68). As a direct consequence we derived a representation for the generating function of arches in (69). For Łukasiewicz walks it is then straightforward to derive its asymptotics.

Proposition 4.2.4 (Asymptotics of arches). *Let $\kappa = C\rho(P_0^\geq)'(\tau)$. For a Łukasiewicz walk, the number of arches satisfies for $n \rightarrow \infty$*

$$[z^n]A(z) = \frac{\kappa\rho^{-n}}{2\sqrt{\pi n^3}} + \mathcal{O}\left(\frac{1}{n^{5/2}}\right).$$

Proof. Define $\lambda := \frac{P_0^\geq(\tau)}{P(\tau)} = \frac{\rho}{\rho_0^\geq}$, then by (72) we get for $z \rightarrow \rho-$

$$A(z) = 1 - \frac{1}{E(z)} = zP_0^\geq(u_1(z)) \quad (80)$$

$$\begin{aligned} &= \rho P_0^\geq(\tau) - C\rho(P_0^\geq)'(\tau)\sqrt{1 - z/\rho} + \mathcal{O}(1 - z/\rho) \\ &= \lambda - \kappa\sqrt{1 - z/\rho} + \mathcal{O}(1 - z/\rho). \end{aligned} \quad (81)$$

From singularity analysis (see Figure 60) we know that $[z^n]\sqrt{1-z} = -1/(2\sqrt{\pi n^3}) + \mathcal{O}(n^{-5/2})$. The n -th coefficient of the error term in (81) is also of the same order $\mathcal{O}(n^{-5/2})$ as due to (73) $u_1(z)$ is a Puiseux-series in $\sqrt{1-z/\rho}$. \square

A *return to zero* is a vertex of a path of altitude 0 whose abscissa is positive, i.e. the number of returns to zero is the number of times the abscissa is touched again after leaving the origin. In order to count the number of returns to zero of excursions of fixed size n , we can reverse the construction above for the generating function of arches. The generating function of excursions with exactly k returns to zero is equal to $A(z)^k$. As stated in [19], for any fixed k , this function also has a singularity of the square root type and is amenable to singularity analysis. Hence, we are able to derive the probability $p_{n,k}$ that a random excursion of size n has exactly k returns to zero for any fixed k :

$$p_{n,k} := \mathbb{P}[\text{size} = n, \# \text{ returns to zero} = k] = \frac{[z^n]A(z)^k}{[z^n]E(z)}. \quad (82)$$

Let X_n be the random variable for the number of arches among all excursions of size n , which is equivalent to the number of returns to zero of a random excursions of size n .

Theorem 4.2.5 (Limit laws for returns to zero of excursions). *Consider the model of Łukasiewicz walks. Let τ be the structural constant determined by $P'(\tau) = 0$, $\tau > 0$, $\rho = 1/P(\tau)$ be the structural radius. Additionally, let $\alpha = (P_0^\geq(u_1(z)))' \Big|_{z=\rho_1}$, $\gamma = \frac{1}{\alpha\rho_1^2+1}$, and $\kappa = C\rho(P_0^\geq)'(\tau)$. Furthermore, we introduce $\alpha_2 = (P_0^\geq(u_1(z)))'' \Big|_{z=\rho_1}$.*

The number X_n of returns to zero of a random excursion of size n admits a limit distribution:

1. *In the supercritical case, i.e. $P(\tau) < P_0^\geq(\tau)$,*

$$\frac{X_n - \mu n}{\sigma\sqrt{n}}, \quad \mu = \gamma, \quad \sigma = \gamma^3(\alpha_2\rho_1^3 - 2) + 3\gamma^2 - \gamma,$$

converges in law to a standard Gaussian variable $N(0,1)$:

$$\lim_{n \rightarrow \infty} \mathbb{P} \left(\frac{X_n - \mu n}{\sigma\sqrt{n}} \leq x \right) = \frac{1}{\sqrt{2\pi}} \int_{-\infty}^x e^{-y^2/2} dy.$$

2. *In the critical case, i.e. $P(\tau) = P_0^\geq(\tau)$, the normalized random variable*

$$\frac{\kappa}{\sqrt{2n}} X_n,$$

converges in law to a Rayleigh distributed random variable defined by the density $xe^{-x^2/2}$:

$$\lim_{n \rightarrow \infty} \mathbb{P} \left(\frac{\kappa}{\sqrt{2n}} X_n \leq x \right) = 1 - e^{-x^2/2}.$$

3. In the subcritical case, i.e. $P(\tau) > P_0^\geq(\tau)$, the limit distribution of $X_n - 1$ is a discrete limit law, namely the negative binomial distribution $\text{NB}(2, 1 - \lambda)$, with $\lambda = \rho/\rho_0^\geq$:

$$\lim_{n \rightarrow \infty} \mathbb{P}[X_n - 1 = k] = (k + 1)\lambda^k(1 - \lambda)^2, \quad \forall k \geq 0.$$

Proof. The proof is given in Section 4.6 and the respective asymptotic representations of the expected values and variances are stated in formulae (100) to (103) therein. \square

Now that we got the asymptotics and limit laws for excursions, we continue to analyze lattice paths constrained in a different way in the next section dedicated to bridges.

4.3 BRIDGES

Recall that a *bridge* is a simple path that starts in the origin and ends on the x -axis. We define the generating function of bridges in the reflection-absorption model as

$$B(z) := \sum_{n \geq 0} b_n z^n := W_0(z).$$

Generating function of bridges

In this section we derive the generating function of bridges and give a combinatorial proof of the result. An analytic proof is given in Section 4.6. It gives an equivalent derivation of Formula (86), while the final simplifications leading to (83) stay the same.

Theorem 4.3.1 (Generating function of bridges). *The generating function of bridges $B(z)$ in the reflection-absorption model of Łukasiewicz walks relative to a simple set of steps \mathcal{S} for altitudes $k \neq 0$ and a simple set of steps \mathcal{S}_0 for altitude $k = 0$ with jump polynomials $P(u)$ and $P_0^\geq(u)$, respectively, is given by*

$$B(z) = \frac{1}{1 - z \left(P_0^\geq(zp_{-1}\tilde{E}(z)) + zp_{0,-1}\tilde{E}(z)(P^\geq)'(zp_{-1}\tilde{E}(z)) \right)}, \quad (83)$$

where $\tilde{B}(z)$ and $\tilde{E}(z)$ are the generating functions of bridges and excursions in the Banderier-Flajolet model, with respect to the step set \mathcal{S} and the jump polynomial $P(u)$.

This formula possesses a very nice and natural combinatorial interpretation. A bridge is a sequence of *general arches* with generating function $A_g(z)$, which we define as bridges which touch the x -axis only at its two end points. These split into the sets of arches counted by $A(z) = zP_0^\geq(zp_{-1}\tilde{E}(z)) = zP_0^\geq(u_1(z))$, which are a subclass of

excursions and were already analyzed in the reflection-absorption model, and *negative arches* $A_-(z)$, which we define as the subclass of bridges, whose first step is negative and which touch the x -axis only at its two endpoints. Hence, we have

$$B(z) = \frac{1}{1 - A_g(z)} = \frac{1}{1 - (A(z) + A_-(z))}, \tag{84}$$

and we see that the generating function of negative arches is given by

$$A_-(z) = z^2 p_{0,-1} \tilde{E}(z) (P^{\geq})'(z p_{-1} \tilde{E}(z)) = z \frac{p_{0,-1}}{p_{-1}} u_1(z) (P^{\geq})'(u_1(z)).$$

Note that the structure of $A_-(z)$ has also a natural interpretation, analogous to the one that is used in the combinatorial proof of Theorem 4.3.1. We just remark that the derivative originates from a pointing operator used to mark the possibilities to jump through or to the x -axis.

Corollary 4.3.2. *Under the same conditions as stated in Theorem 4.3.1 the generating function of bridges in the reflection-absorption model is also given by*

$$B(z) = \frac{\tilde{B}(z)}{\frac{p_{0,-1}}{p_{-1}} + \tilde{B}(z) (1 - z P_0(u_1(z)))}. \tag{85}$$

Proof. We start from Equation (83) and apply (87). Thereby we get

$$1/B(z) = 1 - z \left(\underbrace{P_0^{\geq}(u_1(z)) + \frac{p_{0,-1}}{u_1(z)}}_{=P_0(u_1(z))} - \frac{p_{0,-1}}{p_{-1}} \underbrace{\frac{u_1(z)}{z^2 u_1'(z)}}_{=1/(z\tilde{B}(z))} \right),$$

which directly implies the desired form. □

This last representation (85) nicely shows the perturbation introduced by the new set of rules at altitude 0. We notice that if $P_0(u) = P(u)$ we directly get $B(z) = \tilde{B}(z)$.

Proof of Theorem 4.3.1. We are going to give a recursive construction of bridges. In particular, we introduce an algorithm which transforms bridges of the Banderier-Flajolet model into bridges of the reflection-absorption model by correcting one “wrong” step in each iteration. For the purpose of this proof we denote the set of bridges and excursions of the Banderier-Flajolet model with step set \mathcal{S} , by \mathcal{B} and \mathcal{E} , respectively.

Let us define the set \mathcal{T} as the working set of the algorithm. We start with all bridges from the Banderier-Flajolet model, i.e. $\mathcal{T} := \mathcal{B}$. In the next step we take all elements of \mathcal{T} and look for the first jump starting at altitude 0 which is not part of \mathcal{S}_0 . If such a jump exists we decompose it into a bridge of the reflection-absorption model (which

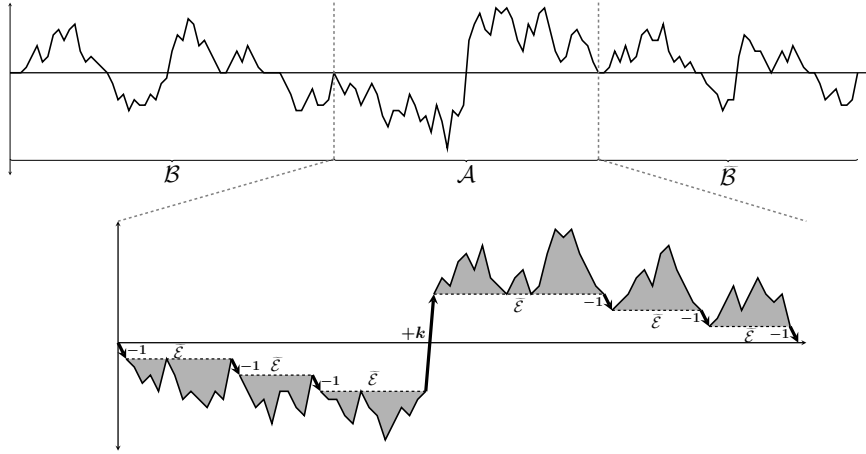

Figure 20: Transformation of bridges from the Banderier-Flajolet model to bridges of the reflection-absorption model (top); decomposition of general arches (bottom).

is the part left of the illegitimate jump), the general arch starting with this jump and a bridge of \mathcal{B} (which is the part right of the arch). This decomposition is always possible as \mathcal{T} and \mathcal{B} contain the empty walk. It is depicted the top of Figure 20.

For all these paths we replace the arch by an arch starting with a step out of \mathcal{S}_0 and all other steps out of \mathcal{S} . This is achieved by deleting all paths of the previous decomposition and adding the ones with a corrected version.

This so far translates into the following equation:

$$B(z) = \underbrace{\tilde{B}(z)}_{\text{all BF-bridges}} - \underbrace{[\mathcal{S}\text{-arch}]\tilde{B}(z)}_{\text{delete first } \mathcal{S}\text{-arch}} + \underbrace{[\mathcal{S}_0\text{-arch}]\tilde{B}(z)}_{\text{add new } \mathcal{S}_0\text{-arch}} + \dots$$

After transforming all bridges with at least one return to zero, we repeat the previous step in order to correct all bridges with at least two returns to zero and apply this step repeatedly. This leads to the following scheme:

$$\begin{aligned} B(z) &= \tilde{B}(z) + \underbrace{([\mathcal{S}\text{-arch}] - [\mathcal{S}_0\text{-arch}])\tilde{B}(z)}_{\text{bridges with } \geq 1 \text{ arch}} \\ &\quad + \underbrace{([\mathcal{S}\text{-arch}] - [\mathcal{S}_0\text{-arch}])^2\tilde{B}(z)^2}_{\text{bridges with } \geq 2 \text{ arches}} + \dots \\ &= \frac{\tilde{B}(z)}{1 - ([\mathcal{S}\text{-arch}] - [\mathcal{S}_0\text{-arch}])\tilde{B}(z)}. \end{aligned}$$

Note that this scheme applies an inclusion-exclusion argument. For example in the second step all bridges with at least two arches are corrected under the condition that all bridges with at least one arch have already been corrected. Hence, we subtract the previous correction and add a new one. This is the reason for the powers in the

correction scheme. Essentially we perform an “arch decomposition” (compare [85, pp. 320]) of each walk and correct arch by arch.

In the final step we have to analyze the arch correction process. We distinguish two cases. Firstly, consider an arch that starts with a non-negative jump, i.e. the first step is of height $k \in \mathcal{S} \setminus \{-1\}$. Now, as the jump -1 is the only possible one to return to the x -axis, this one has to be used at least k times. Therefore we perform a unique first passage decomposition on the jumps -1 : After the initial jump to altitude k follows a possible excursion of the Banderier-Flajolet model using the step set \mathcal{S} and a final jump -1 to altitude $k - 1$. This is repeated until we reach altitude 0 again. Thereby we construct all possible arches with an initial jump of height k . Finally we replace all arches with an initial jump out of \mathcal{S} by the arches with an initial jump out of \mathcal{S}_0 .

This description translates directly into the generating function

$$\sum_{i=0}^{d_0} zp_{0,-1} \left(zp_{-1} \tilde{E}(z) \right)^i - \sum_{i=0}^d zp_i \left(zp_{-1} \tilde{E}(z) \right)^i = z \left(P_0^{\geq} - P^{\geq} \right) \left(zp_{-1} \tilde{E}(z) \right).$$

Secondly, consider an arch with an initial jump -1 . In this case it might happen that a jump crosses the x -axis instead of hitting it. However, the jumps of size -1 are still the only possibilities to move downwards. Therefore after crossing the x -axis we are in the previous case again, and the walk will definitively hit the x -axis. Let k be the size of the jump which crosses the x -axis. Note that crossing might also mean returning. Hence, crossing might happen at the altitudes $-k, -k + 1, \dots, -1$. Hence, the walk must reach these altitudes first.

On the part of the walk below the x -axis we perform a last passage decomposition, i.e. we decompose the walk with respect to the last times it moves from altitude $-i$ to $-i - 1$. Before this last jump -1 it starts on altitude $-i$ and returns to altitude $-i$ but never goes above altitude $-i$. Hence, these pieces are in bijection to excursions which always stay below the x -axis. These excursions are in bijection to normal excursions, which can be seen by flipping them with respect to the x -axis and traversing them in reversed time.

Summarizing, an arch with an initial jump of size -1 possesses a unique jump of size k which crosses the x -axis. This crossing step might start at altitude $-i$ for $i \in \{1, 2, \dots, k\}$. Then on the negative part we have i jumps -1 followed by a possible excursion of the Banderier-Flajolet model and on the positive part we have $k - i$ jumps -1 preceded by excursions of the Banderier-Flajolet model. Such a decomposition is shown in the bottom part of Figure 20. Hence, in total we have a unique decomposition into k jumps -1 , k excursions and one jump of size k starting at altitude $-i$. The dependency on k translates into the combinatorial construction of pointing (see [85, I.6.2]) and gives $u(P^{\geq})'(u)$ with $u = zp_{-1} \tilde{E}(z)$.

Finally, we replace the initial jump -1 from \mathcal{S} by -1 from \mathcal{S}_0 . This translates into

$$z \frac{p_{0,-1} - p_{-1}}{p_{-1}} [u(P^\geq)'](u) \Big|_{u=zp_{-1}\tilde{E}} = z^2 \tilde{E}(p_{0,-1} - p_{-1})(P^\geq)'(zp_{-1}\tilde{E}).$$

Note that we have to divide by p_{-1} because the chosen step which crosses the x -axis is not of size p_{-1} . Combining the last results gives

$$B(z) = \frac{\tilde{B}(z)}{1 - z\tilde{B}(z) \left((P_0^\geq - P^\geq)(\tilde{U}) + z\tilde{E}(z)(p_{0,-1} - p_{-1})(P^\geq)'(\tilde{U}) \right)}, \quad (86)$$

$$\tilde{U}(z) = zp_{-1}\tilde{E}(z).$$

This expression is simplified by the kernel equation. We immediately see that

$$P^\geq(u_1) = \frac{1}{z} - \frac{p_{-1}}{u_1},$$

for $0 < |z| < \rho$. By differentiation we get

$$(P^\geq)'(u_1) = \frac{p_{-1}}{u_1^2} - \frac{1}{z^2 u_1'}, \quad (87)$$

in the same domain. As $c = 1$ we can use (23) to simplify $zp_{-1}\tilde{E}(z) = u_1(z)$. Dividing the numerator by $\tilde{B}(z)$ yields

$$\begin{aligned} & -z \left((P_0^\geq)(u_1(z)) + zp_{0,-1}\tilde{E}(z)(P^\geq)'(u_1(z)) \right) \\ & + \underbrace{\frac{1}{\tilde{B}(z)} + z \left(P^\geq(u_1(z)) + u_1(z)(P^\geq)'(u_1(z)) \right)}_{=:R(z)}. \end{aligned}$$

Using the representations for $\tilde{B}(z) = zu_1'(z)/u_1(z)$ from (20) and the previous results we get

$$R(z) = \frac{u_1}{zu_1'} + z \left(\frac{1}{z} - \frac{p_{-1}}{u_1} + u_1 \left(\frac{p_{-1}}{u_1^2} - \frac{1}{z^2 u_1'} \right) \right) = 1,$$

which shows (83). □

Asymptotics

The asymptotic behavior of the coefficients of $B(z)$ depends on the location of the singularity of the generating function. Therefore, the following lemma gives the root or the singularity of the denominator of (83).

Lemma 4.3.3 (Singularity of the denominator). *Let $u_1(z)$ be the unique small branch of the kernel equation $1 - zP(u) = 0$. Then the equation $1 - zQ(z) = 0$ with $Q(z) = A_g(z)/z = P_0^\geq(u_1(z)) + \frac{p_{0,-1}}{p_{-1}}u_1(z)(P^\geq)'(u_1(z))$ has at most one solution in $z \in (0, \rho]$, which we denote by ρ_B .*

Proof. The fact that $Q(z)$ is monotonically increasing on $(0, \rho]$ as it is the composition of monotonically increasing functions yields the result. For more details see the proof of Lemma 4.2.1. \square

Depending on the existence and the location of ρ_B we define three different cases.

Lemma 4.3.4. *The three possible cases are characterized by*

$$\begin{aligned} \text{Supercritical case: } \rho > \rho_B & \Leftrightarrow P(\tau) < P_0(\tau), \\ \text{Critical case: } \rho = \rho_B & \Leftrightarrow P(\tau) = P_0(\tau), \\ \text{Subcritical case: } \rho_B \text{ undef} & \Leftrightarrow P(\tau) > P_0(\tau). \end{aligned}$$

Proof. We use the shorthand $u_1 \equiv u_1(z)$. The kernel equation implies that $1/z = P(u_1)$ for $z \in [0, \rho]$. Hence we get,

$$P(u_1) - \left(P_0^{\geq}(u_1) + \frac{p_{0,-1}}{p_{-1}} u_1 (P^{\geq})'(u_1) \right) = 0.$$

As this equation only depends on u_1 which is monotonically increasing, it can equivalently be solved for $u := u_1 \in [0, \tau]$. Additionally, due to cancellations for the terms of p_{-1} and $p_{0,-1}$ in $P(u)$ and $P_0(u)$ we get

$$P(u) - \left(P_0(u) + \frac{p_{0,-1}}{p_{-1}} u P'(u) \right) = 0.$$

Note that the term in brackets is monotonically increasing on $[0, \tau]$, because it is nothing else than $Q(u_1^{-1}(u))$, whereas $P(u)$ is monotonically decreasing with a unique positive minimum at τ . Thus, evaluating the left-hand side at $u = \tau$ and considering its parity tells us if ρ_B exists and in which case we are in:

$$P(\tau) - P_0(\tau) \begin{cases} < 0, & \text{supercritical case,} \\ = 0, & \text{critical case,} \\ > 0, & \text{subcritical case.} \end{cases}$$

This shows the claim. \square

An analogous version of the previous lemma with P_0^{\geq} instead of P_0 is obvious in the case of excursions. The naming convention is again motivated by the fact that $B(z)$ is a composition of two generating functions. Then the location of their singularities defines the name giving composition scheme (cf. [85, Chapter VI.9]). For more details see Figure 19.

For the asymptotic expansions around $z = \rho$ the following lemma will be useful:

Lemma 4.3.5. *Let τ be the structural constant determined by $P'(\tau) = 0$, $\tau > 0$. Then for $c = 1$*

$$(P^{\geq})'(\tau) = \frac{p-1}{\tau^2},$$

$$(P^{\geq})''(\tau) = P''(\tau) - \frac{2p-1}{\tau^3}.$$

Proof. Let us consider the complete Laurent polynomial $P(u)$, then we get for the derivatives

$$(P^{\geq})'(u) = P'(u) + \frac{p-1}{u^2},$$

$$(P^{\geq})''(u) = P''(u) - \frac{2p-1}{u^3}.$$

Evaluating these equations at $u = \tau$ yields the results. \square

Theorem 4.3.6 (Asymptotics of bridges). *Let τ be the structural constant determined by $P'(\tau) = 0$, $\tau > 0$, let $\rho = 1/P(\tau)$ be the structural radius and ρ_B defined as in Lemma 4.3.3. Then the constants $\gamma_B = \frac{1}{1+\rho_B^2 Q'(\rho_B)}$, and $\kappa_B = C\rho P'_0(\tau) + \frac{p_0-1}{p-1} \frac{2\tau}{C}$ are positive and the bridges in the reflection-absorption model possess the following asymptotic expansion:*

$$B(z) = \begin{cases} \gamma_B(1 - z/\rho_B)^{-1} + \mathcal{O}(1), & \text{supercritical case: } \rho > \rho_B, \\ \frac{1}{\kappa_B}(1 - z/\rho)^{-1/2} + \mathcal{O}(1), & \text{critical case: } \rho = \rho_B, \\ B(\rho) - B(\rho)^2 \kappa_B(1 - z/\rho)^{1/2} \\ + \mathcal{O}(1 - z/\rho), & \text{subcritical case: } \rho < \rho_B. \end{cases} \quad (88)$$

Proof (Sketch). The same techniques as used in the proof of Theorem 4.2.2 combined with Lemma 4.3.5 lead to the result. To avoid repetition we omit the details. \square

We immediately recognize the same patterns as in the asymptotic expansions of the generating function of excursions $E(z)$. This is no surprise as excursions are a subclass of bridges. The above constants directly transform to the constants given in the excursions case.

Limit laws for the number of returns to zero of bridges

Let us come back to equation (84) and derive the asymptotic number of general arches. We will state this proof in detail, as it shows in a few lines how easily the proofs from Section 4.2 generalize from excursions to bridges.

Proposition 4.3.7 (Asymptotics of general arches). *Let $\kappa_B = C\rho P'_0(\tau) + \frac{p_0-1}{p-1} \frac{2\tau}{C}$. For a Łukasiewicz walk, the number of general arches satisfies for $n \rightarrow \infty$*

$$[z^n]A_g(z) = \frac{\kappa_B}{2} \frac{\rho^{-n}}{\sqrt{\pi n^3}} + \mathcal{O}\left(\frac{1}{n^{5/2}}\right).$$

Proof. Define $\lambda_B := \frac{P_0(\tau)}{P(\tau)}$, then by (83) and (84) we get for $z \rightarrow \rho-$

$$\begin{aligned} A_g(z) &= 1 - \frac{1}{B(z)} = zQ(u_1(z)) \\ &= \rho P_0(\tau) - C\rho \left(P_0'(\tau) + \frac{p_{0,-1}}{p-1} \tau P''(\tau) \right) \sqrt{1-z/\rho} + \mathcal{O}(1-z/\rho) \\ &= \lambda_B - \kappa_B \sqrt{1-z/\rho} + \mathcal{O}(1-z/\rho). \end{aligned}$$

Finally, singularity analysis (see [85, Fig. VI.5]) yields the result. \square

Theorem 4.3.8 (Limit laws for returns to zero of bridges). *Let τ be the structural constant determined by $P'(\tau) = 0$, $\tau > 0$, $\rho = 1/P(\tau)$ be the structural radius. Additionally, let $\gamma_B = \frac{1}{1+\rho_B^2 Q'(\rho_B)}$, $\kappa_B = C\rho P_0'(\tau) + \frac{p_{0,-1}}{p-1} \frac{2\tau}{C}$, and ρ_B and $Q(u)$ are defined in Lemma 4.3.3.*

The number X_n of returns to zero of a random bridge of size n admits a limit distribution:

1. *In the supercritical case, i.e. $\rho > \rho_B$,*

$$\frac{X_n - \mu n}{\sigma \sqrt{n}}, \quad \mu = \gamma_B, \quad \sigma = \gamma_B^3 (Q''(\rho_B)\rho_B^3 - 2) + \gamma_B^2(\rho_B + 2) - \gamma_B,$$

converges in law to a Gaussian variable $N(0,1)$:

$$\lim_{n \rightarrow \infty} \mathbb{P} \left(\frac{X_n - \mu n}{\sigma \sqrt{n}} \leq x \right) = \frac{1}{\sqrt{2\pi}} \int_{-\infty}^x e^{-y^2/2} dy.$$

2. *In the critical case, i.e. $\rho = \rho_B$, the normalized random variable*

$$\frac{\kappa_B}{\sqrt{2n}} X_n,$$

converges in law to a Rayleigh distributed random variable defined by the density $x e^{-x^2/2}$:

$$\lim_{n \rightarrow \infty} \mathbb{P} \left(\frac{\kappa_B}{\sqrt{2n}} X_n \leq x \right) = 1 - e^{-x^2/2}.$$

3. *In the subcritical case, i.e. $\rho < \rho_B$, the limit distribution of $X_n - 1$ is a discrete limit law, namely the negative binomial distribution $NB(2, 1 - \lambda_B)$, with $\lambda_B = P_0(\tau)/P(\tau)$:*

$$\lim_{n \rightarrow \infty} \mathbb{P}[X_n - 1 = k] = (k + 1)\lambda_B^k (1 - \lambda_B)^2, \quad \forall k \geq 0.$$

Proof (Sketch). In order to analyze the number of returns to zero we introduce a bivariate generating function $B(z, u)$ where z marks the length of the walks and u marks the number of general arches given by $A_g(z)$. Using (84) we define

$$\begin{aligned} B(z, u) &= \frac{1}{1 - uA_g(z)} = \frac{1}{1 - uzQ(z)} \\ &= \frac{1}{1 - uz \left(P_0^{\geq}(u_1) + \frac{p_{0,-1}}{p-1} u_1 (P^{\geq})'(u_1) \right)}. \end{aligned}$$

From now on the analysis is analogous to the one in the case of returns to zero of excursions. The only difference is that instead of $P_0^{\geq}(u_1(z))$ the function $Q(z)$ is used. Essentially, this is a more general form of the case of excursions, see Theorem 4.2.5. Thus, the structure of the result is the same, only the constants are different. However, restricting this result to excursions yields the same constants. \square

In order to continue our analysis with meanders, we need to introduce a new parameter: the drift. The next section will introduce and investigate its influence on our model. As in the previous sections we first derive their asymptotic number. Using this knowledge we compute their asymptotic length, interpret the absorption model restricted to meanders, and derive the limit law of their final altitude. Here we will again encounter a Gaussian, a Rayleigh and a discrete limit distribution, but also one of the half-normal type.

4.4 MEANDERS

A *meander* is the natural generalization of an excursion, as it is defined as a directed walk confined to the upper half plane. Hence, the restriction to end on the x -axis is dropped. We want to investigate the number of meanders or equivalently the ratio of meanders among all walks, as we are working with probability generating functions.

From (50) we get the bivariate generating function of meanders as

$$F(z, u) = \frac{1 - z \left(P(u) - P_0^{\geq}(u) \right) E(z)}{1 - zP(u)}, \quad (89)$$

$$E(z) = \frac{1}{1 - zP_0^{\geq}(u_1(z))}.$$

Remark 14. Firstly, let us compare this formula with the one for meanders in the Banderier-Flajolet model. By (24) it is given by $\tilde{F}(z, u) = \prod_{j=1}^c (u - u_j(z)) / (u^c (1 - zP(u)))$, and by (23) the generating function of excursions is given by $\tilde{E}(z) = (-1)^{c+1} (\prod_{j=1}^c u_j(z)) / (z^{p-1})$. Hence, for Łukasiewicz walks Formula (89) transforms into

$$F(z, u) = \frac{u \left(1 - z \left(P(u) - P_0^{\geq}(u) \right) E(z) \right)}{u - u_1} \tilde{F}(z, u)$$

$$= \frac{1 - z \left(P(u) - P_0^{\geq}(u) \right) E(z)}{1 - z \left(P(u) - P^{\geq}(u) \right) \tilde{E}(z)} \tilde{F}(z, u).$$

This representation nicely illustrates the perturbation generated at altitude $k = 0$. If we set $P_0(u) = P(u)$ we obviously also get $E(z) = \tilde{E}(z)$ and the fraction in front of $\tilde{F}(z, u)$ is equal to 1.

Secondly, we want to give a direct combinatorial interpretation of Formula (89). Note that $W(z, u) = 1/(1 - zP(u))$ is the generating

function of unconstrained walks generated by the jump polynomial $P(u)$. Hence, we can rewrite the equation into

$$F(z, u) = W(z, u) - E(z)z \left(P(u) - P_0^{\geq}(u) \right) W(z, u).$$

Behind this formula lies an iterative algorithm which constructs meanders step-by-step. In particular it corrects wrong steps at altitude 0: We start with all unconstrained walks represented by $W(z, u)$. So far only the walk of length 0 is correct. Now assume that walks up to length n are correct. An incorrect walk of length $n + 1$ consists of an excursion of the reflection absorption model, a jump $P(u)$ and any walk represented by $W(z, u)$, where this decomposition is in this order. Hence, replacing $P(u)$ by $P_0^{\geq}(u)$ gives a correct walk of length $n + 1$. This inductive argument resembles the construction in the proof of Theorem 4.1.5 and gave the motivation for the proof of Theorem 4.3.1.

The generating function of meanders is given by the substitution $u = 1$ in (89):

$$M(z) = \sum_{n \geq 0} m_n z^n := F(z, 1) = \frac{1}{1-z} - \left(1 - P_0^{\geq}(1) \right) \frac{zE(z)}{1-z}. \quad (90)$$

In the reflection model we have $P_0^{\geq}(1) = 1$, which confirms that $F(z, u)$ is already the probability generating function of all walks in this case, because our probability space consists only of meanders. However, the absorption model is characterized by $P_0^{\geq}(1) < 1$. This means that some paths may turn below the abscissa and are excluded by the upper half plane restriction, but they still belong to the probability space.

Remark 15. Formula (90) possesses a straightforward combinatorial interpretation, which can also be used to derive it in the first case. A walk can only be killed (or absorbed) after hitting the x -boundary, hence the absorption process only happens for excursions. In this context let e_n be the probability that a random walk of length n is an excursion. A walk survives with probability $P_0^{\geq}(1)$ and is killed with probability $1 - P_0^{\geq}(1)$. The probability m_{n+1} which describes the number of meanders of length $n + 1$ among all walks of length $n + 1$, is given by all surviving walks of smaller length. Thus, we get the recurrence

$$m_{n+1} = 1 - \left(1 - P_0^{\geq}(1) \right) \sum_{k=0}^n e_k, \quad \text{for all } n \geq 0.$$

Multiplying by z^{n+1} and summing over all $n \geq 0$ yields Formula (90).

Before we continue, we need to perform a more thorough investigation of some basic properties concerning the reflection-absorption model. We will see that some configurations can only appear in the reflection model whereas others only exist in the absorption model. Most importantly, the behavior of meanders is strongly connected with a new parameter called the drift.

Drift

Additionally to the structural constant ρ the *drift* defined as

$$\delta = P'(1),$$

and its related value $\delta_0^>$, the *drift at 0*

$$\delta_0^> = \left(P_0^>\right)'(1),$$

will play a major role. They can be interpreted probabilistically as the expected jump sizes of a single step. We start to investigate the structural radius ρ .

Lemma 4.4.1 (Structural radius). *Let $P(u)$ be the jump polynomial with probabilistic weights. Then $\rho \geq 1$, where $\rho = 1$ if and only if $\tau = 1$.*

Proof. As $P''(z) > 0$ for all $z > 0$, it follows that $P(u)$ is a convex function and has a unique minimum at $\tau > 0$. As $P(1) = 1$ it follows that $P(\tau) \leq 1$. This implies $\rho = 1/P(\tau) \geq 1$.

If $\rho = 1$ it obviously holds that $P(\tau) = 1$. The fact that τ is the unique positive minimum of $P(u)$ and that $P(1) = 1$ implies that $\tau = 1$. The converse is trivially true. \square

In the following lemma we see that the drift δ and the structural constant τ are strongly related.

Lemma 4.4.2 (Drift and structural constant). *Let $\delta = P'(1)$ be the drift and $\tau > 0$ be the unique root of $P'(\tau) = 0$, then*

$$\delta > 0 \Leftrightarrow \tau < 1,$$

$$\delta < 0 \Leftrightarrow \tau > 1,$$

$$\delta = 0 \Leftrightarrow \tau = 1.$$

For $\delta > 0$ we have $u_1(1) < 1$ and for $\delta \leq 0$ we have $u_1(1) = 1$, where $u_1(z)$ is the principal small branch of the kernel equation.

Proof. $P(u)$ is a convex function and due to $P'(\tau) = 0$ its unique positive minimum is attained at $\tau > 0$. Hence, it is monotonically decreasing on $[0, \tau]$ and monotonically increasing on $[\tau, \infty)$. Furthermore, we know that $P(1) = 1$ and the first three claims follow from the monotonicity (compare Figure 21).

Note that from the kernel equation (52) it follows that $P(u_1(1)) = 1$. If $\delta > 0$ we have $\tau < 1$ and $\rho > 1$ and because $u_1(z)$ is monotonically increasing we get

$$u_1(1) < u_1(\rho) = \tau < 1.$$

For $\delta \leq 0$ we have $1 \in (0, \tau]$. As $P(u)$ is one-to-one on $(0, \tau]$ and $P(1) = 1$ we directly get $u_1(1) = 1$. \square

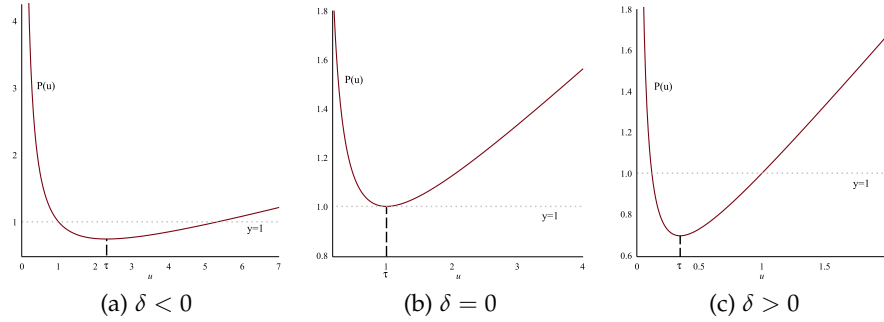

Figure 21: The effects of $\delta = P'(1)$ on τ .

Furthermore, there is also a relation between δ and ρ_1 , the singularity of the $E(z)$ in the supercritical case (see Lemma 4.2.1).

Lemma 4.4.3 (Drift and supercritical singularity). *We have $\rho_1 \geq 1$, where $\rho_1 > 1$ for either $\delta > 0$ or in the absorption model. In the other two cases of the reflection model, namely for $\delta < 0$ or $\delta = 0$, we have $\rho_1 = 1$.*

Proof. The following inequality chain holds due to monotonicity

$$P_0^\geq(u_1(z)) \leq P_0^\geq(u_1(1)) \stackrel{(a)}{\leq} P_0^\geq(1) \stackrel{(b)}{\leq} 1 \leq \frac{1}{z} \quad \text{for all } z \in [0, 1].$$

Observe that (a) is strict if $\delta < 0$ and that (b) is strict in the absorption model. In the last two cases we know therefore that $P_0^\geq(u_1(z)) \neq 1/z$ for all $z \in [0, 1]$ and therefore $\rho_1 > 1$.

If $\delta \leq 0$ we know from Lemma 4.4.2 that $u_1(1) = 1$ and therefore $P_0^\geq(u_1(1)) = 1$ since we are dealing with the reflection model. This finally implies $\rho_1 = 1$. \square

The results of Lemma 4.4.3 are summarized in Table 7.

	$\delta < 0$	$\delta = 0$	$\delta > 0$
reflection model	$\rho_1 = 1$	$\rho_1 = 1$	$\rho_1 > 1$
absorption model	$\rho_1 > 1$	$\rho_1 > 1$	$\rho_1 > 1$

Table 7: Values of ρ_1 in the supercritical case

Finally, note that the zero and negative drift cases need a more careful treatment.

Lemma 4.4.4 (Zero drift). *The case $\delta = 0$ can only appear in the critical case of the reflection model or the subcritical case of the absorption model.*

Proof: If $\delta = 0$ we know that $\tau = 1$. As $P_0^\geq(u)$ is the extraction of $P_0(u)$, which has probabilistic weights, we must have $P_0^\geq(1) \leq 1$. If we look at the different cases we get the desired results:

- Supercritical case: $1 = P(\tau) < P_0^\geq(\tau) = P_0^\geq(1) \leq 1$, contradiction;
- Critical case: $1 = P(\tau) = P_0^\geq(\tau) = P_0^\geq(1)$, ref. model;
- Subcritical case: $1 = P(\tau) > P_0^\geq(\tau) = P_0^\geq(1)$, abs. model. □

The results of Lemma 4.4.4 are summarized in Table 8.

$\delta = 0$	supercritical	critical	subcritical
reflection model	no	yes	no
absorption model	no	no	yes

Table 8: Possible cases for $\delta = 0$ in both models

Lemma 4.4.5 (Negative drift). *If $\delta < 0$ in the reflection model only the supercritical case is possible.*

Proof. We know that P_0^\geq is monotonically increasing, but as $\delta < 0$ the function P is monotonically decreasing on $[0, \tau]$ with the unique minimum $P(\tau)$. The critical condition $P(\tau) = P_0^\geq(\tau)$ as well as the subcritical condition $P(\tau) > P_0^\geq(\tau)$ imply that $P_0^\geq(u) < P(u)$ for all $u \in [0, \tau]$. But in the reflection model we have $P_0^\geq(1) = 1 = P(1)$ which yields a contradiction as $\tau > 1$ for $\delta < 0$ (see Figure 22). □

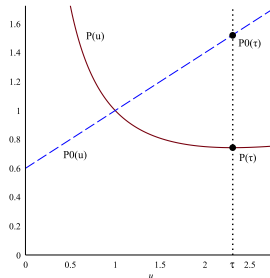

Figure 22: Example of a supercritical case with drift $\delta < 0$ in the ref. model showing the jump polynomials $P(u)$ and $P_0^\geq(u) = P_0(u)$. This is the only possible configuration.

Again, the results of Lemma 4.4.5 are summarized in Table 9.

$\delta < 0$	supercritical	critical	subcritical
reflection model	yes	no	no

Table 9: Possible cases for $\delta < 0$ in the reflection model

With these results we continue our analysis of meanders.

Asymptotics

According to the last section the asymptotics of meanders in the absorption model consist of 7 different cases depending on the critical behavior and the drift.

Theorem 4.4.6 (Asymptotics of meanders). *Consider Łukasiewicz walks. Let τ be the structural constant determined by $P'(\tau) = 0$, $\tau > 0$, $\rho = 1/P(\tau)$ be the structural radius, $\delta = P'(1)$ be the drift and $\delta_0^\geq = (P_0^\geq)'(1)$ be the drift at 0. Additionally, let $\alpha = (P_0^\geq(u_1(z)))'|_{z=\rho_1}$, $\gamma = \frac{1}{\alpha\rho_1^2+1}$, and $\kappa = C\rho(P_0^\geq)'(\tau)$. The ratio of meanders of size n is asymptotically given in Table 10.*

$[z^n]M(z) \sim$	$\delta < 0$	$\delta = 0$	$\delta > 0$
Supercritical	$\frac{\rho_1\gamma}{E(1)(\rho_1-1)}\rho_1^{-n}$	—	$1 - (1 - P_0^\geq(1))E(1)$
Critical	$\frac{\rho}{E(1)\kappa(\rho-1)}\frac{\rho^{-n}}{\sqrt{\pi n}}$	—	
Subcritical	$\frac{E(\rho)^2}{E(1)}\frac{\kappa\rho}{2(\rho-1)}\frac{\rho^{-n}}{\sqrt{\pi n^3}}$	$\frac{E(1)\kappa}{\sqrt{\pi n}}$	

Table 10: Asymptotic ratio of meanders with respect to unconstrained walks in the absorption model ($P_0^\geq(1) < 1$) with $\delta = P'(1)$ as the drift.

Proof. The proof is given in Section 4.6. It applies Theorem 4.2.2 and the preceding results on the drift in order to distinguish different cases. □

Expected positive prefix length of unconstrained walks in the absorption model

Let us reconsider the difference between the reflection and the absorption model. The crucial point is the x -axis. In the reflection model *all* paths always remain in the first quadrant, however, in the absorption model *some* want to leave the first quadrant through the x -axis but are absorbed instead. Thus, the main difference is that in the reflection model the probability space is formed by meanders, whereas, in the absorption model the probability space is formed by walks.

Now let us think of a different point of view. Instead of restricting to meanders let us consider unconstrained walks and decide whether it is a meander by traversing the paths and checking the positivity condition. In other words we start at the origin, and follow the trajectory of the path through our grid. In every step the probability encoded by either $P(u)$ or $P_0(u)$ determines the next step.

In the reflection model we know that this path will go on forever. But in the absorption model it might happen that it is absorbed at

one point. In this chapter we want to answer the question of which parameters are responsible for this absorption process. In particular we consider unconstrained walks of fixed length N . Under a *positive prefix* we understand the part of a walk starting from the origin, which stays above the x -axis and is maximal in size, see Figure 23. Then we are interested in the expected length of the positive prefix for a random walk of length N . Therefore, from now on, we consider only the absorption model.

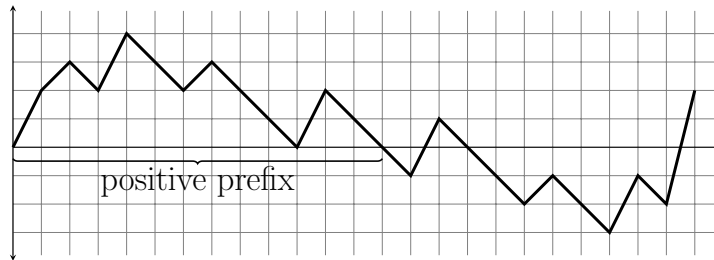

Figure 23: A random walk of length 24 with a positive prefix length 13.

Note that this parameter can also be interpreted as the waiting time (i.e. the length) for the first jump below the x -axis when traversing the path starting from the origin. We want to compute the expected waiting time of such an event.

Intuition tells us that the drift will play the most important role on the behavior of the length. On the one hand, by Theorem 4.4.6 we know that for non-positive drift, $\delta \leq 0$, a walk will be absorbed with probability 1. Yet, for zero drift, $\delta = 0$, the decay is much slower than for negative drift. On the other hand, for positive drift, $\delta > 0$, a walk moves away from the x -boundary, which means that it is very unlikely that it is absorbed. Therefore, we might expect a constant length for negative drift, and a linear length for positive drift. The case of a zero drift is harder to answer. The following theorem gives the result.

Let $N \in \mathbb{N}$, and let Y_N denote the random variable of the length of the positive prefix of a randomly chosen walk of fixed length N .

Theorem 4.4.7 (Expected positive prefix length). *Consider the model of Łukasiewicz walks. Let τ be the structural constant determined by $P'(\tau) = 0$, $\tau > 0$, $\rho = 1/P(\tau)$ be the structural radius, $\delta = P'(1)$ be the drift and $\delta_0^{\geq} = (P_0^{\geq})'(1)$ be the drift at 0. The asymptotics of the waiting time for the first negative ordinate for walks of length $N \in \mathbb{N}$ in the absorption model are determined by the drift δ .*

For negative drift $\delta < 0$ we get, where in the supercritical case ρ is replaced by ρ_1

$$\mathbb{E}(Y_N) = E(1) \left(1 - \frac{\delta_0^{\geq}}{\delta} \right) + \mathcal{O}(\rho^{-N}).$$

For zero drift $\delta = 0$ we get

$$\mathbb{E}(Y_N) = 2\delta_0^{\geq} E(1) \sqrt{\frac{2N}{P''(1)\pi}} + \mathcal{O}(1).$$

For positive drift $\delta > 0$ we get

$$\mathbb{E}(Y_N) = \left(1 - (1 - P_0^{\geq}(1))E(1)\right) N + \mathcal{O}(1).$$

Proof. The proof is given in Section 4.6. □

Asymptotic number of excursions and arches in the absorption model

In order to get a better understanding of the absorption model let us consider the previous results in the restricted probability space. Therefore, all we need to do is to normalize the ratio of excursions of length n by the ratio of meanders of length n . We define the ratio of excursions among meanders as e_n^m and the ratio of arches among meanders as a_n^m . Additionally, we will also look on the ratio of arches among excursions, which we denote by a_n^e . Essentially, these probabilities are nothing else than conditional probabilities:

$$e_n^m := \mathbb{P}(\omega \text{ being an excursion} \mid \omega \text{ is a meander of length } n) = \frac{e_n}{m_n},$$

$$a_n^m := \mathbb{P}(\omega \text{ being an arch} \mid \omega \text{ is a meander of length } n) = \frac{a_n}{m_n},$$

$$a_n^e := \mathbb{P}(\omega \text{ being an arch} \mid \omega \text{ is an excursion of length } n) = \frac{a_n}{e_n}.$$

In other words, e_n^m is the probability that a randomly chosen meander of length n is an excursion, whereas a_n^m is the probability that it is an arch. In the same way, we get by a_n^e the probability that a randomly chosen excursion of length n is an arch.

The asymptotic values of these probabilities are easily computed by a combination of the results from Theorem 4.2.2, Proposition 4.2.4 and Theorem 4.4.6.

$e_n^m \sim$	$\delta < 0$	$\delta = 0$	$\delta > 0$
Supercritical	$\left(1 - \frac{1}{\rho_1}\right) E(1)$	—	$\frac{\gamma}{1 - (1 - P_0^{\geq}(1))E(1)} \rho_1^{-n}$
Critical	$\left(1 - \frac{1}{\rho}\right) E(1)$	—	$\frac{1}{\kappa(1 - (1 - P_0^{\geq}(1))E(1))} \frac{\rho^{-n}}{\sqrt{\pi n}}$
Subcritical	$\left(1 - \frac{1}{\rho}\right) E(1)$	$E(1) \frac{\rho^{-n}}{2n}$	$\frac{E(\rho)^2 \kappa}{2(1 - (1 - P_0^{\geq}(1))E(1))} \frac{\rho^{-n}}{\sqrt{\pi n^3}}$

Table 11: Asymptotic probability that a randomly chosen meander in the absorption model is an excursion.

$a_n^m \sim$	$\delta < 0$	$\delta = 0$	$\delta > 0$
Supercritical	$\left(1 - \frac{1}{\rho_1}\right) \frac{E(1)\kappa}{2\gamma\sqrt{\pi n^3}} \left(\frac{\rho_1}{\rho}\right)^n$	—	$\frac{\kappa}{2(1-(1-P_0^\geq(1))E(1))} \frac{\rho^{-n}}{\sqrt{\pi n^3}}$
Critical	$\left(1 - \frac{1}{\rho}\right) \frac{E(1)\kappa^2}{2n}$	—	
Subcritical	$\left(1 - \frac{1}{\rho}\right) \frac{E(1)}{E(\rho)^2}$	$\frac{1}{E(1)} \frac{\rho^{-n}}{2n}$	

Table 12: Asymptotic probability that a randomly chosen meander in the absorption model is an arch.

From the previous results we know that meanders depend on the critical behavior and the drift, whereas excursions depend only on the critical behavior, and arches are independent of these two parameters. Thus, the asymptotics of meanders is responsible for the 7 different cases in the Tables 11 and 12.

$a_n^e \sim$	δ arbitrary
Supercritical	$\frac{\kappa}{2\gamma\sqrt{\pi n^3}} \left(\frac{\rho_1}{\rho}\right)^n$
Critical	$\frac{\kappa^2}{2n}$
Subcritical	$\frac{1}{E(\rho)^2}$

Table 13: Asymptotic probability that a randomly chosen excursion in the absorption model is an arch.

In Table 13 we notice that in the supercritical and critical case a_n^e goes to zero for increasing n . But it is interesting to see that this proportion is constant in the subcritical case. In terms of the used constant $\lambda = P_0^\geq(\tau)/P(\tau)$ of Proposition 4.2.4, we can express $1/E(\rho)^2$ as $(1 - \lambda)^2$. Remark that in the subcritical case we have $0 < \lambda < 1$.

When comparing the three tables, we clearly see their relationship

$$a_n^e \cdot e_n^m = a_n^m,$$

which naturally results from their definition.

Expected final altitude of meanders

The *final altitude* of a path is defined as the ordinate of its endpoint. Recall that the bivariate generating function of meanders is given in (89) as

$$F(z, u) = \frac{1 - z \left(P(u) - P_0^\geq(u) \right) E(z)}{1 - zP(u)}, \quad E(z) = \frac{1}{1 - zP_0^\geq(u_1(z))}.$$

Let X_n be the random variable associated to the final altitude of all meanders of length n . It satisfies

$$\mathbb{P}[X_n = k] = \frac{[z^n u^k]F(z, u)}{[z^n]F(z, 1)}.$$

As mentioned before, in the reflection model $F(z, u)$ is already the probability generating function of meanders. This follows from the constructions of our probability space consisting only of meanders. Whereas in the absorption model we have $P_0^{\geq}(1) < 1$, i.e. some paths may turn below the abscissa and are excluded by the meander-restriction. Thus, in order to get the probability in the absorption model, $[z^n u^k]F(z, u)$ has to be normalized by $[z^n]F(z, 1)$.

As a first step we compute the expected value for large n . From basic principles we know:

$$\mathbb{E}[X_n] = \frac{[z^n] \left. \frac{\partial}{\partial u} F(z, u) \right|_{u=1}}{[z^n]F(z, 1)}. \tag{91}$$

Theorem 4.4.8 (Expected final altitude of meanders). *Let us consider the model of Łukasiewicz walks. Let τ be the structural constant determined by $P'(\tau) = 0$, $\tau > 0$, $\rho = 1/P(\tau)$ be the structural radius, $\delta = P'(1)$ be the drift and $\delta_0^{\geq} = (P_0^{\geq})'(1)$ be the drift at 0. The asymptotics of the expected final altitude of meanders for the reflection model are given in Table 14 and for the absorption model are given in Table 15.*

$\mathbb{E}(X_n) \sim$	$\delta < 0$	$\delta = 0$	$\delta > 0$
Supercritical	$\frac{\delta_0^{\geq} P''(1) - \delta (P_0^{\geq})''(1)}{2\delta(\delta - \delta_0^{\geq})}$	—	δn
Critical	—	$\sqrt{\frac{2}{\pi}} \sqrt{P''(1)n}$	
Subcritical	—	—	

Table 14: Asymptotics of $\mathbb{E}(X_n)$ in the reflection model ($P_0^{\geq}(1) = 1$) with drift $\delta = P'(1)$ and drift at 0 $\delta_0^{\geq} = (P_0^{\geq})'(1)$.

Proof. The full proof is given in Section 4.6. It is omitted as it does not shed any new insight, and is mostly technical. In short, here we combine the previous results on meanders and excursions, and apply singularity analysis. □

Remark 16. The results of the Tables 14 and 15 mostly fit the intuitive interpretation of the problems. On the one hand, for a negative drift, we get a bounded expected final altitude, as the walks tend to return to the x -axis. On the other hand, for a positive drift the walks tend to move away from the x -axis. Hence, their expected final altitude is

$\mathbb{E}(X_n) \sim$	$\delta < 0$	$\delta = 0$	$\delta > 0$
Supercritical	$\left(1 - \frac{1}{\rho_1}\right) E(1)G(\rho_1)$	—	δn
Critical	$\left(1 - \frac{1}{\rho}\right) E(1)G(\rho)$	—	
Subcritical	$\left(1 - \frac{1}{\rho}\right) E(1) \left(G(\rho) - \frac{\delta\rho(1-\lambda)}{(1-\rho)^2}\right)$	$\sqrt{\frac{\pi}{2}} \sqrt{P''(1)n}$	

Table 15: Asymptotics of $\mathbb{E}(X_n)$ in the absorption model ($P_0^{\geq}(1) < 1$) with drift $\delta = P'(1)$, drift at 0 $\delta_0^{\geq} = (P_0^{\geq})'(1)$, and $\lambda = \frac{P_0^{\geq}(\tau)}{P(\tau)}$. The function $G(z)$ is defined in Equation (117).

linear in n . Additionally, it makes sense that as they move away from the different rule set at altitude $k = 0$ it does not influence their final altitude anymore. Intuitively, we would expect the altitude of a walk of length n to be n times the expected height of a single jump (i.e. δ).

But in the case of zero drift, it is not completely clear what is happening. Some walks might move away, and reach an arbitrarily high altitude, but definitively slower, than in the case of positive drift. Thus, the speed $\mathcal{O}(\sqrt{n})$ compared to $\mathcal{O}(n)$ and $\mathcal{O}(1)$ makes sense, but the constants are not clear. We see that $P''(1)$, which can be interpreted as variance, plays a major role, but additionally $\sqrt{2/\pi}$ and $\sqrt{\pi/2}$ appear. These constants are very similar, but their origin is not obvious. In Theorem 4.4.10 we will see that the limit distributions are either a half-normal distribution in the reflection model, or a Rayleigh distribution in the absorption model. Interestingly, this is the only case, where for the same behavior of the drift, two different probability distributions appear in the different models. However, this interesting property can already be suspected by the glimpse of their explicit first moments.

Limit laws for the final altitude of meanders

This section is dedicated to the derivation of the limit laws for the final altitude of meanders. Let u be a fixed positive real number in $(0, 1)$. Then the dominant singularity of $F(z, u)$ from (89) is either $z = \rho$, the singularity of $E(z)$, or $z = 1/P(u) =: \rho(u)$, the singularity of the denominator. Which one is the dominant one? This depends on the value of the drift δ , but first the following lemma will partly answer this question.

Lemma 4.4.9. *Let $F(z, u)$ be the probability generating function of meanders from (89), with z marking length and u marking final altitude. For $z \in (0, \rho)$ and $u \in (0, \tau)$ this function is analytic at $z = 1/P(u)$.*

Proof. As mentioned before $F(z, u)$ is either singular at the singularity $z = 1/P(u)$ of the denominator or at the singularity $z = \rho$ of $E(z)$. First, note that $1/P(u) < \rho$ for $u \in (0, \tau)$ as $P(u)$ is monotonically decreasing on $(0, \tau]$ with the minimum $\rho = 1/P(\tau)$. Therefore, $E(z)$ is regular at $z = 1/P(u)$ for $u \in (0, \tau)$ and so this value is a likely candidate for the dominant singularity of $F(z, u)$.

Next, we investigate the denominator at $z = 1/P(u)$. The kernel equation tells us that $u_1(z)$ satisfies

$$\frac{1}{P(u_1(z))} = z, \quad \text{for } z \in (0, \rho). \quad (92)$$

On the one hand $u_1(z)$ is monotonically increasing for $z \in (0, \rho)$ from 0 to τ , yet on the other hand $P(u)$ is monotonically decreasing for $u \in (0, \tau)$ from $+\infty$ to ρ . Therefore, we have $1/P(u) \in (0, \rho)$ for $u \in (0, \tau)$. Inserting $z = 1/P(u)$ into (92) and using that $P(u)$ is one-to-one on $(0, \tau)$ yields

$$u_1\left(\frac{1}{P(u)}\right) = u, \quad \text{for } u \in (0, \tau).$$

Hence, $u_1(z)$ and $1/P(u)$ are inverse on $z \in (0, \rho)$ or $u \in (0, \tau)$, respectively.

Now we get for $E(z)$ at $z = 1/P(u)$, $u \in (0, \tau)$:

$$E\left(\frac{1}{P(u)}\right) = \frac{1}{1 - \frac{P_0^{\geq}(u_1(1/P(u)))}{P(u)}} = \frac{P(u)}{P(u) - P_0^{\geq}(u)}.$$

But this implies that the numerator is zero for $z \rightarrow 1/P(u)$. As $E(z)$ is regular at $z = 1/P(u)$ a Taylor expansion of the numerator gives a convergent series starting without constant term in $(z - 1/P(u))$. Hence, the singularity of the denominator is canceled, and we retrieve a convergent series, i.e. an analytic function at $z = 1/P(u)$ for $u \in (0, \tau)$. \square

Theorem 4.4.10 (Limit laws for the final altitude of meanders). *Consider the model of Łukasiewicz walks. Let τ be the structural constant determined by $P'(\tau) = 0$, $\tau > 0$, $\rho = 1/P(\tau)$ be the structural radius, $\delta = P'(1)$ be the drift and $\delta_0^{\geq} = (P_0^{\geq})'(1)$ be the drift at 0.*

Let X_n be the random variable associated with the final altitude of a random meander of size n . It admits a limit distribution, with the limit law being dictated by the value of the drift δ .

1. *For a negative drift, $\delta < 0$, the limit distribution is discrete. In the supercritical case ρ is replaced by ρ_1 in the following results. The limit distribution is characterized by*

$$g(u) = \rho \frac{P_0^{\geq}(u) - P(u)}{1 - \rho P(u)}.$$

a) In the reflection model it is given as

$$\lim_{n \rightarrow \infty} \mathbb{P}[X_n = k] = [u^k] \gamma g(u),$$

$$\text{where } \gamma = \frac{1}{\alpha \rho_1^2 + 1} \text{ and } \alpha = (P_0^{\geq}(u_1(z)))' \Big|_{z=\rho_1}.$$

b) In the absorption model we have

$$\lim_{n \rightarrow \infty} \mathbb{P}[X_n = k] = [u^k] E(1) \left(1 - \frac{1}{\rho}\right) g(u).$$

2. In the case of zero drift, $\delta = 0$, the normalized random variable

$$\frac{X_n}{\sqrt{P''(1)n}},$$

a) converges in the reflection model in law to a half-normally distributed random variable defined by the density $\sqrt{\frac{2}{\pi}} e^{-x^2/2}$:

$$\lim_{n \rightarrow \infty} \mathbb{P} \left(\frac{X_n}{\sqrt{P''(1)n}} \leq x \right) = \sqrt{\frac{2}{\pi}} \int_0^x e^{-t^2/2} dt.$$

b) converges in the absorption model in law to a Rayleigh distributed random variable defined by the density $x e^{-x^2/2}$:

$$\lim_{n \rightarrow \infty} \mathbb{P} \left(\frac{X_n}{\sqrt{P''(1)n}} \leq x \right) = 1 - e^{-x^2/2}.$$

3. In the case of a positive drift, $\delta > 0$, the standardized version of X_n ,

$$\frac{X_n - \mu n}{\sigma \sqrt{n}}, \quad \mu = \delta, \quad \sigma^2 = P''(1) + \delta - \delta^2,$$

converges in the reflection model and the absorption model in law to a standard Gaussian variable $N(0, 1)$:

$$\lim_{n \rightarrow \infty} \mathbb{P} \left(\frac{X_n - \mu n}{\sigma \sqrt{n}} \leq x \right) = \frac{1}{\sqrt{2\pi}} \int_{-\infty}^x e^{-y^2/2} dy.$$

Proof. The proof is given in Section 4.6. We apply singularity analysis combined with several limit laws, like the Continuity Theorem [85, Theorem IX.1], the Rayleigh scheme by Drmota-Soria [70, Theorem 1], the method of moment convergence by Fréchet and Shohat [90], and the Quasi-Power's Theorem by H.K. Wang [85, Theorem IX.8]. \square

4.5 MOMENTS OF THE DISTRIBUTION FOR THE FINAL ALTITUDE OF MEANDERS

Following the ideas of the proof of Theorem 4.4.10 for the case of the reflection model for drift $\delta = 0$ we want to investigate the final altitude of meanders under the angle of moments. Of course these results follow immediately from previous result. Hence, this should be considered, as an alternative way to derive them.

Let X be a random variable, then the k -th moment of X ($k \in \mathbb{N}$) is defined as

$$m_k := \mathbb{E}(X^k).$$

For example, $\mathbb{E}(X) = m_1$ is the mean of the distribution and $\mathbb{V}(X) = m_2 - m_1^2$ gives the variance. The knowledge of the moments is a good starting point, in order to identify the distribution. This is the strategy we want to follow within this section.

As we are working with generating functions, we are going to encounter *factorial moments*. The k -th factorial moment of X is defined as

$$m_k := \mathbb{E}((X)_k) = \mathbb{E}(X(X-1)\cdots(X-k+1)),$$

where $(x)_k := x(x-1)\cdots(x-k+1)$ is the *falling factorial*. Clearly m_k is given via terms involving m_1, \dots, m_k and vice versa, i.e. $m_1 = m_1$, $m_2 = m_2 - m_1^2$ and so on. Therefore the knowledge of the first k moments and the first k factorial moments is equivalent.

Let $F(z) = \sum_{n \geq 0} f_n z^n$ be a probability generating function. The k -th factorial moment is

$$m_k = \left. \frac{d^k}{dz^k} F(z) \right|_{z=1},$$

which can be seen via the representation $F(z) = \mathbb{E}(z^X)$. Hence, we need to investigate the derivatives of our bivariate generating function $F(z, u)$ in u to derive the factorial moments.

We start with determining the structure of the factorial moments. Therefore we take a closer look on the structure of $F(z, u)$ with regards to u and interpret z as a parameter. In (89) and (112) we see that the governing structure is

$$S(u) = \frac{Q(u)}{1 - zP(u)}, \quad (93)$$

where we could have $Q(u) = 1$ or $Q(u) = P(u) - P_0^>(u)$. Next, we investigate the derivatives at $u = 1$ of $S(u)$.

Lemma 4.5.1. *For the function $S(u)$ defined in (93) we have*

$$S^{(k)}(u) = \sum_{i=0}^k S_{k,i}(u) \frac{z^i}{(1 - zP(u))^{i+1}},$$

$$S^{(k)}(1) = \sum_{i=0}^k s_{k,i} \frac{z^i}{(1 - z)^{i+1}},$$

where $S^{(k)}(u)$ stands for the k -th derivative of $S(u)$ and $s_{k,i} = S_{k,i}(1) \in \mathbb{R}$ for all $i, k \in \mathbb{N}$. The functions $S_{k,i}(u)$ satisfy the following recurrence relations

$$\begin{aligned} S_{k+1,0}(u) &= (S_{k,0})'(u), \\ S_{k+1,i}(u) &= iS_{k,i-1}(u)P'(u) + (S_{k,i})'(u), \quad i = 1, \dots, k, \\ S_{k+1,k+1}(u) &= (k+1)S_{k,k}(u)P'(u), \end{aligned} \quad (94)$$

where $S_{0,0}(u) = Q(u)$.

Proof. The proof is given by induction on k . For $k = 0$ we have

$$S(u) = S_{0,0}(u) \frac{1}{1 - zP(u)} = Q(u) \frac{1}{1 - zP(u)}.$$

Hence, it holds $S_{0,0}(1) = Q(1)$. We assume the statement holds for $k \geq 0$ and show its validity for $k + 1$:

$$\begin{aligned} S^{(k+1)}(u) &= \frac{d}{du} \sum_{i=0}^k S_{k,i}(u) \frac{z^i}{(1 - zP(u))^{i+1}} \\ &= \sum_{i=0}^k \left((S_{k,i})'(u) \frac{z^i}{(1 - zP(u))^{i+1}} + S_{k,i}(u) \frac{(i+1)P'(u)z^{i+1}}{(1 - zP(u))^{i+2}} \right) \\ &= \frac{(S_{k,0})'(u)z^0}{1 - zP(u)} + \sum_{i=1}^k \frac{(iS_{k,i-1}(u)P'(u) + (S_{k,i})'(u))z^i}{(1 - zP(u))^{i+1}} \\ &\quad + \frac{(k+1)S_{k,k}(u)P'(u)z^{k+1}}{(1 - zP(u))^{k+2}}. \end{aligned}$$

Thus, we see that (94) holds and the lemma is proven. \square

Let us solve this equation for some specific values

Lemma 4.5.2. *For the functions from Lemma 4.5.1 we get the following results*

$$S_{k,0}(u) = Q^{(k)}(u), \quad S_{k,k}(u) = k!Q(u)(P'(u))^k;$$

and the following special values: $s_{k,0} = Q^{(k)}(1)$, $s_{k,k} = k!Q(1)\delta^k$ and

$$s_{k,k-1} = k!\delta^{k-2} \left(\frac{k-1}{2} P''(1)Q(1) + \delta Q'(1) \right), \quad \text{for } k \geq 1.$$

Proof. For fixed k the first and the last function $S_{k,0}(u)$ and $S_{k,k}(u)$ are easily computed by successive iteration. For the last result one first shows that

$$(S_{n,n})'(1) = n\delta^{n-1} (nP''(1)Q(1) + \delta Q'(1)).$$

Then one takes the derivative in the recurrence relation of $S_{k,k-1}(u)$ from (94) and solves this one also iteratively, and with the help of the previous result. \square

The k -th factorial moment for X_n is given as

$$\mathbf{m}_k^n := \begin{cases} [z^n] \frac{\partial^k F(z, u)}{\partial u^k} \Big|_{u=1}, & \text{in the reflection model,} \\ \frac{[z^n] \frac{\partial^k F(z, u)}{\partial u^k} \Big|_{u=1}}{[z^n] F(z, 1)}, & \text{in the absorption model.} \end{cases}$$

Hence, we need the n -th coefficients of the functions of Lemma 4.5.1. These are easily extracted, as we are dealing with standard functions.

$$[z^n] \frac{z^i}{(1-z)^{i+1}} = \begin{cases} 0, & \text{for } n < i, \\ 1, & \text{for } n = i, \\ \frac{(n+1)(n+2)\cdots(n+i)}{i!}, & \text{for } n > i. \end{cases} \quad (95)$$

That is why for large n the n -th coefficient behaves asymptotically like $\frac{n^i}{i!}$. Using (89) we derive the structure of the k -th derivative of $F(z, u)$:

$$\begin{aligned} \frac{\partial^k}{\partial u^k} F(z, u) &= \frac{\partial^k}{\partial u^k} \frac{1}{1-zP(u)} - zE(z) \frac{\partial^k}{\partial u^k} \frac{P(u) - P_0^{\geq}(u)}{1-zP(u)} \\ &= \sum_{i=0}^k \frac{S_{k,i}(u)z^i}{(1-zP(u))^{i+1}} - zE(z) \sum_{i=0}^k \frac{T_{k,i}(u)z^i}{(1-zP(u))^{i+1}}. \end{aligned} \quad (96)$$

We set

$$S_{0,0}(u) = 1 \quad \text{and} \quad T_{0,0}(u) = P(u) - P_0^{\geq}(u). \quad (97)$$

Defining $s_{k,i} := S_{k,i}(1)$ and $t_{k,i} := T_{k,i}(1)$ and substituting $u = 1$ yields

$$\frac{\partial^k}{\partial u^k} F(z, u) \Big|_{u=1} = \sum_{i=0}^k \left(s_{k,i} \frac{z^i}{(1-z)^{i+1}} - t_{k,i} z^{i+1} \frac{E(z)}{(1-z)^{i+1}} \right). \quad (98)$$

The n -th coefficient of the above equation is the k -th factorial moment \mathbf{m}_k^n . The first term is easy to deal with applying (95), yet for the second one we use (115).

Let us now consider the two models individually. The general strategy will be to analyze (98) with the help of (115) and the results from Lemma 4.5.1. When looking for the dominant contribution, remember that $[z^n] \frac{z^i}{(1-z)^{i+1}} = \mathcal{O}(n^i)$.

We start with the reflection model. It is characterized by $P_0^{\geq}(1) = 1$, but this implies that $T(1) = 0$ which is the reason why $t_{k,k} = 0$ for all $k \in \mathbb{N}$.

R1. The case $\delta < 0$ is only possible in the supercritical case. Then, Lemma 4.4.3 implies that $\rho_1 = 1$ which gives by (115) that $[z^n] \frac{E(z)}{(1-z)^{i+1}} = \mathcal{O}(n^{i+1})$. Therefore the leading terms of (98) are coming from $s_{k,k}$ and $t_{k,k-1}$. We get

$$\mathbf{m}_k^n = \frac{n^k}{k!} \left(s_{k,k} - \frac{t_{k,k-1}}{\alpha + 1} \right) + \mathcal{O}(n^{k-1}).$$

Due to Lemma 4.6.3 we have $1 + \alpha = 1 - \frac{\delta_0^{\geq}}{\delta} = \frac{T'_{0,0}(1)}{\delta}$. Thus, the expressions for $s_{k,k}$ and $t_{k,k-1}$ defined in Lemma 4.5.2 with the respective start values from (97) give that $s_{k,k} - \frac{t_{k,k-1}}{\alpha+1}$ is equal to

$$k! \underbrace{S_{0,0}(1)}_{=1} \delta^k - \frac{k! \delta^{k-1}}{(T_{0,0})'(1)} \left(\frac{k-1}{2} P''(1) \underbrace{T_{0,0}(1)}_{=0} + \delta (T_{0,0})'(1) \right) = 0.$$

R2. The case $\delta = 0$ was already treated in detail in the proof of Theorem 4.4.10. There a less general approach was employed, as the $s_{k,i}$'s and $t_{k,i}$'s could be computed directly. This is due to a lot of cancellations and simplifications due to $\delta = 0$, $T_{0,0}(1) = 0$ and $(S_{0,0})'(1) = 0$. For completeness we show the first steps of this approach.

As $\rho = 1$ we get from (115) that $[z^n] \frac{E(z)}{(1-z)^{i+1}} = \mathcal{O}(n^{i+1/2})$. Because $t_{k,k} = 0$, the dominant part would come from $s_{k,k}$, but this factor is also zero, as $\delta = 0$. Thus, we need to consider $t_{k,k-1}$. Again, by Lemma 4.5.2 we get in this special case that

$$t_{k,k-1} = \begin{cases} -\delta_0^{\geq}, & \text{for } k = 1, \\ 0, & \text{else,} \end{cases}$$

because $T_{0,0}(1) = 0$ in the reflection model. For $k \geq 2$ we need to consider $s_{k,k-1}$:

$$s_{k,k-1} = \begin{cases} P''(1), & \text{for } k = 2, \\ 0, & \text{else,} \end{cases}$$

because $(S_{0,0})'(u) = 0$. Analogously, such expressions can be derived for higher moments. Finally, with the help of (98) these results yield the asymptotic moments.

R3. Finally, let us deal with $\delta > 0$. Here, $[z^n] \frac{E(z)}{(1-z)^{i+1}} = \mathcal{O}(n^i)$ and therefore only $s_{k,k}$ is responsible for the dominant term. Hence, we get

$$m_k^n = \frac{n^k}{k!} s_{k,k} + \mathcal{O}(n^{k-1}) = (\delta n)^k + \mathcal{O}(n^{k-1}).$$

In the absorption model $P_0^{\geq}(1) < 1$ and therefore $T(1) \neq 0$, but remember that in this model we still have to divide by the total number of meanders of length n given by $[z^n]F(z, 1)$, compare Section 4.4 (see Table 10). Furthermore, by Lemma 4.4.3 we have $\rho_1 > 1$ in all cases.

A1. We start again with $\delta < 0$. We know from Lemma 4.4.9 that $F(z, u)$ is analytic at $z = \frac{1}{p(u)}$ for $u \in (0, \tau)$. From Lemma 4.4.2

we deduce that $\tau > 1$. Thus, $F(z, u)$ is analytic at $z = \frac{1}{P(1)}$ and therefore (98) is singular at $\rho > 1$ or $\rho_1 > 1$, respectively.

Considering the structure of the k -th derivative at $u = 1$ in (96) we see, that the general structure is $A(z) + B(z)E(z)$, $A(z)$ with

$$A(z) = \frac{\partial^k}{\partial u^k} \frac{1}{1 - zP(u)} \Big|_{u=1} \quad \text{and}$$

$$B(z) = -z \frac{\partial^k}{\partial u^k} \frac{P(u) - P_0^{\geq}(u)}{1 - zP(u)} \Big|_{u=1}.$$

Both of these functions are singular at $z = 1$. However, the sum is analytic there, and the singularity is at $z = \rho$ coming from $E(z)$. There, $B(z)$ is regular and thus from Theorem 2.5.1 we deduce that

$$[z^n] \frac{\partial}{\partial u} F(z, u) \Big|_{u=1} = B(\rho)[z^n]E(z).$$

Without loss of generality we state only the case for ρ . Finally, normalizing by the total number of meanders we get

$$m_k^n = (1 - \rho)E(1)B(\rho) + o(1).$$

A2. For $\delta = 0$ only the subcritical case exists in the absorption model. The same techniques as applied in the proof of Theorem 4.4.10 give the result:

$$m_k^n = \begin{cases} (P''(1)n)^\ell 2^\ell \ell! + \mathcal{O}(n^{\ell-1/2}), & \text{for } k = 2\ell, \\ \sqrt{\frac{\pi}{2}} \frac{(2\ell+1)!}{2^\ell \ell!} \sqrt{(P''(1)n)^{2\ell+1}} + \mathcal{O}(n^{\ell-1/2}), & \text{for } k = 2\ell+1. \end{cases}$$

A3. The case $\delta > 0$ is analogous to the reflection model. By (115) we get that $[z^n] \frac{E(z)}{(1-z)^{i+1}} = \mathcal{O}(n^i)$. Thus, $s_{k,k} = k!\delta^k$ and $t_{k,k} = k!\delta^k(1 - P_0^{\geq}(1))$ are needed and easily computed from Lemma 4.5.2. This gives

$$[z^n] \frac{\partial}{\partial u} F(z, u) \Big|_{u=1} = \frac{n^k}{k!} (s_{k,k} - E(1)t_{k,k}) + \mathcal{O}(n^{k-1})$$

$$= (\delta n)^k \left(1 - (1 - P_0^{\geq}(1))E(1)\right) + \mathcal{O}(n^{k-1}).$$

Normalizing yields the result:

$$m_k^n = (\delta n)^k + \mathcal{O}(n^{k-1}).$$

So we have just proved the following theorem.

$m_k^n =$	$\delta < 0$	$\delta = 0$	$\delta > 0$
Supercritical	$\mathcal{O}(n^{k-1})$	—	$(\delta n)^k + \mathcal{O}(n^{k-1})$
Critical	—	$C_k(P''(1)n)^{k/2} + \mathcal{O}(n^{(k-1)/2})$	
Subcritical	—	—	

Table 16: Asymptotics of the factorial moments m_k^n for the final altitude in the reflection model ($P_0^\geq(1) = 1$) with $\delta = P'(1)$. For even $k = 2\ell$ we have $C_k = \frac{(2\ell)!}{2^\ell \ell!}$, whereas for odd $k = 2\ell + 1$ we have $C_k = 2^\ell \ell! \sqrt{\frac{2}{\pi}}$.

m_k^n	$\delta < 0$	$\delta = 0$	$\delta > 0$
Supercritical	$(1 - \rho)E(1)B(\rho) + o(1)$	—	$(\delta n)^k + \mathcal{O}(n^{k-1})$
Critical		—	
Subcritical		$D_k(P''(1)n)^{k/2} + \mathcal{O}(n^{(k-1)/2})$	

Table 17: Asymptotics of the factorial moments m_k^n for the final altitude in the absorption model ($P_0^\geq(1) < 1$) with $\delta = P'(1)$, and $B(z) = -z \frac{\partial^k}{\partial u^k} \frac{P(u) - P_0^\geq(u)}{1 - zP(u)} \Big|_{u=1}$. For even $k = 2\ell$ we have $D_k = 2^\ell \ell!$, whereas for odd $k = 2\ell + 1$ we have $D_k = \sqrt{\frac{\pi}{2}} \frac{(2\ell+1)!}{2^\ell \ell!}$.

Theorem 4.5.3 (Asymptotic moments of the final altitude of meanders). *Consider the model of Łukasiewicz walks. Let τ be the structural constant determined by $P'(\tau) = 0$, $\tau > 0$, $\rho = 1/P(\tau)$ be the structural radius, and $\delta = P'(1)$ be the drift. The asymptotic moments of the final altitude of meanders for the reflection model are given in Table 16 and for the absorption model are given in Table 17.*

Note that these tables are a generalization of Tables 14 and 15 which compute the concrete values for $k = 1$.

Example 4.5.4. Let us compare the results from Table 16 to the ones computed in Table 14. They should be the same if we set $k = 1$. We will need the following values

$$s_{1,1} = S_{1,1}(1) = 1 \cdot S_{0,0}(1)P'(1) = \delta,$$

$$t_{1,0} = T_{1,0}(1) = (T_{0,0})'(1) = (P - P_0^\geq)'(1) = \delta - \delta_0^\geq.$$

Consider the following three relevant cases:

1. $\delta < 0$ and supercritical case:

$$m_1 = n \left(s_{1,1} - \frac{t_{1,0}}{\alpha + 1} \right) + o(n) = n \frac{\alpha\delta + \delta_0^{\geq}}{\alpha + 1} + o(n) = o(n).$$

From Lemma 4.6.3 it follows that $\alpha\delta = -\delta_0^{\geq}$. This corresponds to the calculations in the previous chapter that the expected value is constant. In order to get the proper value, we would need to consider the next terms in the asymptotic expansion which are, as expected, of order $\mathcal{O}(1)$.

2. $\delta = 0$ and critical case:

$$m_1 = -\frac{t_{1,0}}{\kappa} \frac{\sqrt{n}}{\Gamma(3/2)} + o(\sqrt{n}) = \frac{2\delta_0^{\geq}}{\kappa} \sqrt{\frac{n}{\pi}} + o(\sqrt{n}).$$

3. $\delta > 0$ and all cases:

$$m_1 = ns_{1,1} + o(n) = \delta n + o(n).$$

This confirms the preceding results.

4.6 PROOFS

The subsequent proofs will mostly use the methods from Section 2.3. They involve many tedious computations, which is why they are stated at the end of the chapter.

The usage of many theorems can be described by the drift δ . Its sign often gives an indication of which limit law one could expect and which theorems are applicable. In the case of a negative drift we will use the Continuity Theorem, Theorem 2.3.1. For zero drift we will use the Rayleigh distribution scheme, Theorem 2.3.8, and the method of moments given in Theorem 2.3.10. For a positive drift the Quasi-powers Theorem, Theorem 2.3.2, will play a key role.

Proof of Theorem 4.2.5

Let us start with the numerator of (82). From (81) we know that $A(z) \sim \lambda - \kappa\sqrt{1 - z/\rho}$, where $\lambda = \frac{P_0^{\geq}(\tau)}{P(\tau)}$ and $\kappa = C\rho(P_0^{\geq})'(\rho)$. Hence, the singular expansion of $A^k(z)$ is given by

$$A(z)^k \sim \lambda^k - k\lambda^{k-1}\kappa\sqrt{1 - z/\rho},$$

and we get for the asymptotic number of excursions of size n with k returns to zero

$$[z^n]A(z)^k \sim k\lambda^{k-1}\kappa \frac{\rho^{-n}}{2\sqrt{\pi n^3}}.$$

Next we consider the denominator and compute the fraction in (82). The asymptotic number of excursions is given in Theorem 4.2.2. For this purpose we need to consider three different cases:

1. *Supercritical case:* $P(\tau) < P_0^\geq(\tau)$

In this case $\lambda > 1$ and $\rho_1 < \rho$ imply that

$$p_{n,k} \sim \frac{\kappa}{\gamma} k \lambda^{k-1} \frac{1}{2\sqrt{\pi n^3}} \left(\frac{\rho_1}{\rho}\right)^n.$$

For fixed k and $n \rightarrow \infty$ these probabilities tend to 0. Hence, this cannot be a discrete limit law and we suspect a continuous limit law. The key idea is to use the bivariate generating function $E(z, u)$ where u marks the number of arches and z the length of excursions. As every excursion is a sequence of arches, the scheme for the class of excursions \mathcal{F} where the number of arches are marked by u is $\mathcal{F} = \text{SEQ}(u\mathcal{A})$. With the generating function for the class of arches \mathcal{A} from (80) we get

$$E(z, u) = \frac{1}{1 - uzP_0^\geq(u_1(z))}. \quad (99)$$

This structure is already sufficient to deduce the Gaussian limit law from Theorem 2.3.3. In our case $g(y) = 1/(1-y)$ and $h(z) = zP_0^\geq(u_1(z))$. The values ρ_g and ρ_h are the radii of convergence of g and h , respectively, and $\tau_h = h(\rho_h)$. Hence, $\rho_g = 1$, $\rho_h = \rho$ and $\tau_h = \rho P_0^\geq(\tau)$. The supercriticality condition is exactly the condition $P(\tau) < P_0^\geq(\tau)$ for the supercritical case. All the other conditions are also met, which implies that the number of arches admits a Gaussian limit law.

More details of the distribution are given by Proposition 2.3.4. In a similar manner to $\alpha = (P_0^\geq \circ u_1)'(\rho_1)$ we also define $\alpha_2 = (P_0^\geq \circ u_1)''(\rho_1)$. Computing the first and second derivatives and substituting $z = \rho_1$ gives

$$\begin{aligned} h'(z) &= P_0^\geq(u_1(z)) + z(P_0^\geq \circ u_1)'(z), \\ h'(\rho_1) &= \frac{\alpha\rho_1^2 + 1}{\rho_1} = \frac{1}{\rho_1\gamma}, \\ h''(z) &= 2(P_0^\geq \circ u_1)'(z) + z(P_0^\geq \circ u_1)''(z), \\ h''(\rho_1) &= 2\alpha + \rho_1\alpha_2. \end{aligned}$$

From the definition of γ we get that $\alpha = \frac{1-\gamma}{\gamma\rho_1^2}$. Hence, the expected value and variance are asymptotically equal to

$$\begin{aligned} \mathbb{E}(X_n) &\sim n\gamma, \\ \mathbb{V}(X_n) &\sim n\gamma(\gamma^2(\alpha_2\rho_1^3 - 2) + 3\gamma - 1). \end{aligned} \quad (100)$$

2. *Critical Case:* $P(\tau) = P_0^\geq(\tau)$

In this case $\lambda = \frac{P_0^\geq(\tau)}{P(\tau)} = 1$ gives that

$$p_{n,k} \sim \frac{\kappa^2 k}{2n}.$$

Analogously, for fixed k and $n \rightarrow \infty$ these probabilities tend to 0. Hence, this cannot be a discrete limit law either.

To get an idea of the underlying distribution it proves useful to estimate the mean first. We have

$$\mathbb{E}(X_n) = \frac{[z^n] \frac{\partial}{\partial u} E(z, u) \Big|_{u=1}}{[z^n] E(z)}.$$

Using the definition of $E(z)$ in (72) and (99) we get

$$\frac{\partial}{\partial u} E(z, u) \Big|_{u=1} = E(z)^2 - E(z).$$

Now it is easy to use the asymptotic expansion of $E(z)$ to derive the expected value by (77). Precisely, we find

$$\mathbb{E}(X_n) \sim \frac{\sqrt{2}}{\kappa} \sqrt{\frac{\pi n}{2}}, \quad \kappa = \rho C(P_0^\geq)'(\tau). \quad (101)$$

Note that a standard Rayleigh distribution has mean $\sqrt{\pi/2}$, and we are going to show that this is indeed the underlying distribution by applying Theorem 2.3.8.

Firstly, we investigate the structure of $E(z, u)$. In a neighborhood of $z = \rho$ and $u = 1$ we deduce the following decomposition needed in Hypothesis [H]:

$$\begin{aligned} E(z, u)^{-1} &= 1 - uzP_0^\geq(u_1(z)) \\ &= g(z, u) + h(z, u)\sqrt{1 - z/\rho}. \end{aligned}$$

The functions $g(z, u)$ and $h(z, u)$ are analytic in the specified domain. This follows from (73) and the local representation in a neighborhood of $z = \rho$ of the kind

$$P_0^\geq(u_1(z)) = P_0^\geq(\tau) - (P_0^\geq)'(\tau)C\sqrt{1 - z/\rho} + \mathcal{O}(1 - z/\rho).$$

Secondly, as $\rho = \rho_1$ (compare Lemma 4.2.1) from the last representation it is easy to deduce that $g(\rho, 1) = 1 - \rho P_0^\geq(u_1(\rho)) = 0$, and that $h(\rho, 1) = \rho C(P_0^\geq)'(\tau) = \kappa > 0$. Hence, we can apply Theorem 2.3.8. Therefore, we compute the parameter ϑ . We need $g_u(\rho, 1) = -\rho P_0^\geq(u_1(\rho)) = -1$, which implies that $\vartheta = \kappa^2/2$. Thus, we get the same asymptotic result for the expected value as in (101) and the following result on the variance:

$$\mathbb{V}(X_n) \sim (4 - \pi) \frac{n}{\kappa^2}.$$

3. Subcritical Case: $P(\tau) > P_0^\geq(\tau)$

In this case $\lambda < 1$ gives that

$$p_{n,k} \sim \frac{1}{E(\rho)^2} k \lambda^{k-1}.$$

Above equation can be simplified via the identity

$$E(\rho) = \frac{1}{1 - \rho P_0^{\geq}(\tau)} = \frac{1}{1 - \lambda}.$$

This gives a discrete limit law, as the above probability is independent of the length n . With $p = 1 - \lambda$ and $r = 2$ we have $X_n - 1 \sim \text{NB}(2, 1 - \lambda)$, which is the negative binomial distribution from Section 2.1. This distribution describes the probability for k fails before the r -th success when the probability for success in each trial is p . Finally, we state the expected value and variance:

$$\mathbb{E}(X_n - 1) = \frac{2\lambda}{1 - \lambda}, \quad \mathbb{E}(X_n) = \frac{1 + \lambda}{1 - \lambda}, \quad (102)$$

$$\mathbb{V}(X_n - 1) = \frac{2\lambda}{(1 - \lambda)^2}, \quad \mathbb{V}(X_n) = \mathbb{V}(X_n - 1). \quad (103)$$

Analytic Proof of Theorem 4.3.1

In the following we give an analytic proof of Formula (86).

We will need the following technical lemma:

Lemma 4.6.1. *Let $v_1(z), \dots, v_d(z)$ be the large branches and $u_1(z)$ be the small branch of the kernel equation $1 - zP(u) = 0$ with $P(u) = \sum_{i=-1}^d p_i u^i$. Let $m \in \{0, 1, \dots, d - 1\}$. Then the functions*

$$S_m(z) := (-1)^m p_d \sum_{1 \leq i_1 < i_2 < \dots < i_m \leq d} \prod_{j=1}^m v_{i_j},$$

admit the following recurrence relation

$$\begin{aligned} S_m(z) &= p_{d-m} + u_1(z) S_{m-1}(z), \\ S_0(z) &= p_d, \end{aligned}$$

and its solution is given by

$$S_m(z) = p_{d-m} + p_{d-m+1} u_1 + \dots + p_d u_1^d.$$

Proof. The most important observation is that for small z the kernel equation possesses $d + 1$ distinct roots. Therefore we obtain the factorization

$$u - zuP(u) = -zp_d(u - u_1(z))(u - v_1(z)) \cdots (u - v_d(z)). \quad (104)$$

Let $n \in \{2, 3, \dots, d\}$. Extracting the n -th coefficient in u from (104) yields

$$p_{n-1} = (-1)^{d-n+1} p_d \sum_{0 \leq i_1 < i_2 < \dots < i_{d-n+1} \leq d} \prod_{j=1}^{d-n+1} v_{i_j},$$

where we define $v_0 := u_1$. Rewriting this expression in terms of $S_m(z)$ we get

$$p_{n-1} = \underbrace{(-1)^{d-n+1} p_d \sum_{1 \leq i_1 < i_2 < \dots < i_{d-n+1} \leq d} \prod_{j=1}^{d-n+1} v_{i_j}}_{=S_{d-n+1}(z)} - u_1(z) \cdot \underbrace{(-1)^{d-n} p_d \sum_{1 \leq i_2 < \dots < i_{d-n+1} \leq d} \prod_{j=1}^{d-n} v_{i_j}}_{S_{d-n}(z)}.$$

Setting $m = d - n$ we get the desired recurrence relation. The initial condition follows from extracting the d -th coefficient in u , as we get

$$\underbrace{-p_d (v_1 + v_2 + \dots + v_d)}_{=S_1(z)} = p_{d-1} + p_d u_1.$$

The solution is easily obtained by successive iteration. □

Let us start with the bivariate generating function of walks (45). The u^0 -coefficient is equal to

$$B(z) = [u^0] \frac{1}{1 - zP(u)} - zB(z)[u^0] \frac{P(u) - P_0^{\geq}(u)}{1 - zP(u)}, \tag{105}$$

where $B(z) = F_0(z)$. From (19) we deduce that the first term is $\tilde{B}(z)$, the generating function of bridges in the Banderier-Flajolet model. W.l.o.g. we assume $d = d_0$ as all surplus p_i and $p_{0,j}$ coefficients may be set to 0. For the second term we get

$$\begin{aligned} [u^0] \frac{P(u) - P_0^{\geq}(u)}{1 - zP(u)} &= \sum_{i=-1}^d (p_i - p_{0,-1}) [u^{-i}] W(z, u) \\ &= \sum_{i=-1}^d (p_i - p_{0,-1}) W_{-i}(z). \end{aligned}$$

For the elements in the sum starting from $i = 0$ we apply (21) and afterwards (20) to get explicit expressions in the small branch $u_1(z)$.

$$\begin{aligned} \sum_{i=0}^d (p_i - p_{0,-1}) W_{-i}(z) &= z \sum_{i=0}^d (p_i - p_{0,-1}) \frac{u_1'(z)}{u_1^{1-i}(z)} \\ &= z \frac{u_1'(z)}{u_1(z)} \sum_{i=0}^d (p_i - p_{0,i}) u_1^i(z) \\ &= \tilde{B}(z) \left(P^{\geq} - P_0^{\geq} \right) (u_1(z)) \end{aligned}$$

Then (23) gives that in the case of Łukasiewicz walks we have $u_1(z) = zp_{-1}\tilde{E}(z)$. Therefore (105) yields

$$B(z) = \frac{\tilde{B}(z)}{1 - z\tilde{B}(z) \left(P_0^{\geq} - P^{\geq} \right) (zp_{-1}\tilde{E}(z)) - z(p_{0,-1} - p_{-1})W_1(z)},$$

which already resembles most parts of (83). All that is left, is to show that $W_1(z) = z\tilde{B}(z)\tilde{E}(z)(P^\geq)'(u_1(z))$, which is also the hardest part of the proof.

As a first step we represent $W_1(z)$ with the help of (22) as

$$W_1(z) = -z \sum_{j=1}^d \frac{v'_j(z)}{v_j(z)^2}.$$

Extracting the u^0 -th coefficient of (104) gives

$$p_{-1} = (-1)^{d+1} p_d u_1(z) \prod_{j=1}^d v_j(z).$$

With the help of this formula and $u_1(z) = zp_{-1}\tilde{E}(z)$ we rewrite $W_1(z)$ as

$$W_1(z) = -z^2 \tilde{E}(z) (-1)^{d+1} p_d \underbrace{\sum_{j=1}^d \frac{v'_j(z)}{v_j(z)} \prod_{i \neq j} v_i(z)}_{=: S(z)},$$

where the product has the range $i = \{1, \dots, d\} \setminus \{j\}$. As a next step we use (20) in the representation with large branches and rewrite the sum into

$$S = \sum_{j=1}^d \left(\underbrace{\left(\frac{v'_1}{v_1} + \dots + \frac{v'_d}{v_d} \right) \prod_{i \neq j} v_i}_{=-\tilde{B}(z)/z} - \left(\frac{v'_1}{v_1} + \dots + \frac{v'_{j-1}}{v_{j-1}} + \frac{v'_{j+1}}{v_{j+1}} + \dots + \frac{v'_d}{v_d} \right) \prod_{i \neq j} v_i \right).$$

Now we see that the second term is actually the derivative of the first one without $\tilde{B}(z)$, i.e.

$$S = -\frac{\tilde{B}(z)}{z} \sum_{j=1}^d \left(\prod_{i \neq j} v_i \right) - \frac{d}{dz} \left(\sum_{j=1}^d \prod_{i \neq j} v_i \right).$$

These terms arise from the kernel as coefficients of u in (104) and have been treated in detail in Lemma 4.6.1. Now we can rewrite W_1 in terms of $S_{d-1}(z)$ and get

$$W_1(z) = z\tilde{B}(z)\tilde{E}(z) \left(S_{d-1}(z) + \frac{z}{\tilde{B}(z)} \frac{d}{dz} S_{d-1}(z) \right).$$

Finally, we can use Lemma 4.6.1 and again (20) to get

$$\begin{aligned} W_1(z) &= z\tilde{B}(z)\tilde{E}(z) \left(S_{d-1}(z) + \frac{u_1(z)}{u'_1(z)} \frac{d}{dz} S_{d-1}(z) \right) \\ &= z\tilde{B}(z)\tilde{E}(z) \left(p_1 + 2p_2 u_1(z) + 3p_3 u_1(z)^2 + \dots + dp_d u_1(z)^{d-1} \right) \\ &= z\tilde{B}(z)\tilde{E}(z) (P^\geq)'(u_1(z)), \end{aligned}$$

which proves the claim (86).

Proof of Theorem 4.4.6

As a first step we derive the following lemma.

Lemma 4.6.2. *Let $E(z)$ be the probability generating function of excursions. Then*

$$[z^n] \frac{E(z)}{1-z} = \begin{cases} E(1) + \frac{[z^n]E(z)}{1-\rho} + o(\rho^{-n}), & \text{for } \rho > 1 \text{ or the supercritical} \\ & \text{case with } \rho_1 > 1 \text{ instead of } \rho, \\ \frac{1}{\alpha+1}n + \mathcal{O}(1), & \text{for } \rho_1 = 1 \text{ in the supercr. case,} \\ \frac{2}{\kappa} \sqrt{\frac{n}{\pi}} + \mathcal{O}\left(\frac{1}{\sqrt{n}}\right), & \text{for } \rho = 1 \text{ in the critical case,} \\ E(1) - E(1)^2 \kappa \frac{1}{\sqrt{\pi n}} & \text{for } \rho = 1 \text{ in the subcr. case.} \\ + \mathcal{O}\left(\frac{1}{\sqrt{n^3}}\right), & \end{cases}$$

Proof. The strategy consists of using (75) and elementary singularity analysis, like [85, Fig. VI.5] in order to derive the error terms.

For $\rho > 1$ or $\rho_1 > 1$ we know that $E(z)$ is regular at $z = 1$ and moreover an analytic function on $|z| < \rho$. Thus, the considered function has a simple pole at $z = 1$ with residue $E(1)$:

$$\frac{E(z)}{1-z} = \frac{E(1)}{1-z} + \frac{E(z) - E(1)}{1-z}.$$

The second term is analytic at $z = 1$ and has radius of convergence ρ . Therefore, in order to derive the error term we perform the following manipulation:

$$\frac{E(z) - E(1)}{1-z} = \frac{E(z) - E(1)}{1-\rho} + \frac{z-\rho}{1-\rho} \frac{E(z) - E(1)}{1-z}.$$

Now we apply the $[z^n]$ -operator to extract the error term. The first term gives $\frac{[z^n]E(z)}{1-\rho}$. For the second term, which is responsible for the error term, we use Theorem 4.2.2.

- In the supercritical case we replace ρ by ρ_1 . Then the multiplication of $(z - \rho_1)$ kills the simple pole at $z = \rho_1$ and we obtain a convergent power series at $z = \rho_1$. Therefore, its radius of convergence is strictly larger than ρ_1 and we get the its coefficients behave like $o(\rho_1^{-n})$.
- In the critical case the type of the dominant singularity becomes of the kind $(1 - z/\rho)^{1/2}$ which implies that its coefficients behave like $\mathcal{O}(n^{-3/2}\rho^{-n})$ and are therefore also $o(\rho^{-n})$.
- In the subcritical case it is similar, as the coefficients of $(z - \rho)E(z)$ behave like $(1 - z/\rho)^{3/2}$ and are therefore asymptotically $\mathcal{O}(n^{-5/2}\rho^{-n})$. Hence, they are also of order $o(\rho^{-n})$.

The cases $\rho_1 = 1$ and $\rho = 1$ directly follow from Theorem 4.2.2. \square

Note that for $\rho > 1$ or $\rho_1 > 1$ we will see that cancellations will kill the leading (constant) term, which is why the next term will be of significance.

The strategy is to investigate (90) part by part. As mentioned earlier, the ratio is trivially 1 in the reflection case. So, henceforth we are going to concentrate on the absorption model only. As a first step we simplify this equation by

$$\frac{zE(z)}{1-z} = \frac{E(z)}{1-z} - E(z).$$

Hence, we need to compute

$$[z^n]M(z) = 1 - \left(1 - P_0^{\geq}(1)\right) \left([z^n]\frac{E(z)}{1-z} - [z^n]E(z)\right).$$

In the case of $\rho > 1$ or $\rho_1 > 1$ this lemma implies that (w.l.o.g we state it only for ρ):

$$[z^n]M(z) \sim 1 - \left(1 - P_0^{\geq}(1)\right) \left(E(1) - \frac{\rho}{\rho-1}[z^n]E(z)\right). \quad (106)$$

Combining all these results we need to consider three different cases. In the sequel we are going to refer to the components of equation (90) as first, second and third term, respectively.

- *supercritical case:*

Lemma 4.4.3 implies that $\rho_1 > 1$ in the absorption model, however note that $\rho_1 < \rho$. In this way, we get from (106) and (79) that

$$[z^n]M(z) \sim 1 - \left(1 - P_0^{\geq}(1)\right) \left(E(1) - \frac{\rho_1\gamma}{\rho_1-1}\rho_1^{-n}\right).$$

Let us investigate

$$E(1) = \frac{1}{1 - P_0^{\geq}(u_1(1))}. \quad (107)$$

Some cases have to be treated separately. By Lemma 4.4.2 we get $u_1(1) = 1$ for $\delta \leq 0$ and that $u_1(1) < 1$ for $\delta > 0$. Due to Lemma 4.4.4 there cannot be a supercritical case for $\delta = 0$ in the absorption model. In the case of $\delta < 0$ the asymptotic above simplifies to

$$[z^n]M(z) \sim \left(1 - P_0^{\geq}(1)\right) \frac{\rho_1\gamma}{\rho_1-1} \rho_1^{-n},$$

where for $\delta > 0$ it is given by

$$[z^n]M(z) \sim 1 - \left(1 - P_0^{\geq}(1)\right)E(1) = \left(P_0^{\geq}(1) - P_0^{\geq}(u_1(1))\right)E(1). \quad (108)$$

- *critical case:*

Due to Lemma 4.4.4 is $\delta \neq 0$ and therefore $\rho > 1$. Next we combine (106) and (79) to get

$$[z^n]M(z) \sim 1 - (1 - P_0^{\geq}(1)) \left(E(1) - \frac{\rho}{\kappa(\rho-1)} \frac{P(\tau)^n}{\sqrt{\pi n}} \right).$$

Due to the same reasons as in the supercritical case we get because of Lemma 4.4.2 and (107) that

$$[z^n]M(z) \sim \begin{cases} (1 - P_0^{\geq}(1)) \frac{\rho}{\kappa(\rho-1)} \frac{P(\tau)^n}{\sqrt{\pi n}}, & \text{for } \delta < 0, \\ 1 - (1 - P_0^{\geq}(1))E(1), & \text{for } \delta > 0. \end{cases}$$

- *subcritical case:*

Again, we have to distinguish between $\delta \leq 0$ which implies $u_1(1) = 1$ and $\delta > 0$ which results in $u_1(1) < 1$. As before we use (79) to derive the asymptotic results. First we look at $\delta = 0$ which implies $\rho = 1$. Then we get by Lemma 4.6.2

$$\begin{aligned} [z^n]M(z) &= 1 - (1 - P_0^{\geq}(1)) \left(E(1) - E(1)^2 \kappa \frac{1}{\sqrt{\pi n}} \right) + \mathcal{O}\left(\frac{1}{\sqrt{n^3}}\right) \\ &= \frac{E(1)\kappa}{\sqrt{\pi n}} + \mathcal{O}\left(\frac{1}{\sqrt{n^3}}\right). \end{aligned}$$

In the case $\delta > 0$ we have $\rho > 1$. Then there are no cancellation and the leading term of (106) is obtained from the first and the second term by applying Theorem 2.5.1 as

$$[z^n]M(z) \sim 1 - (1 - P_0^{\geq}(1))E(1).$$

For $\delta < 0$ the first two terms cancel and the asymptotics are derived from the third term given in (79) as

$$[z^n]M(z) \sim (1 - P_0^{\geq}(1)) \frac{\kappa \rho E(\rho)^2 P(\tau)^n}{2(\rho-1) \sqrt{\pi n^3}}.$$

This ends the proof of Theorem 4.4.6.

Proof of Theorem 4.4.7

Consider all walks of length N . We directly get that

$$\mathbb{E}(Y_N) = \sum_{n=0}^N n \mathbb{P}[Y_N = n] = \sum_{n=0}^N \mathbb{P}[Y_N \geq n].$$

The probability $\mathbb{P}[Y_N \geq n]$ describes all walks of length N that haven't been absorbed in the first n steps, i.e. none of their first n steps is

below the x -axis. This probability is given by the ratio of meanders of length n , i.e.

$$\mathbb{P}[Y_N \geq n] = m_n,$$

This observation implies the following formula in terms of generating functions

$$\mathbb{E}(Y_N) = [z^N] \frac{M(z)}{1-z}. \quad (109)$$

In the absorption model we have

$$M(z) = \frac{1 - (1 - P_0^{\geq}(1)) z E(z)}{1-z}. \quad (110)$$

Substituting $z = 1$ into $E(z)$ is well-defined, as $u_1(1) \leq 1$ and $P_0^{\geq}(1) < 1$, compare (107). From Lemma 4.4.2 we know that $u_1(1) = 1$ if and only if $\delta \leq 0$. In these cases the numerator in (110) and the denominator evaluate to 0.

The following technical result will be useful in this and the next proof.

Lemma 4.6.3. *Let $P_0^{\geq}(u)$ be the non-negative part of $P_0(u)$ and $u_1(z)$ the small branch of the kernel equation (51) in the Łukasiewicz case. Then the following expansion holds for $z \rightarrow 1$:*

$$P_0^{\geq}(u_1(z)) = \begin{cases} P_0^{\geq}(u_1(1)) - a_1(1-z) & \text{for } \rho > 1, \\ + \frac{a_2}{2}(1-z)^2 + o((1-z)^2), & \\ P_0^{\geq}(1) - \kappa\sqrt{1-z} + \mathcal{O}(1-z), & \text{for } \rho = 1, \end{cases}$$

with $a_1 = (P_0^{\geq} \circ u_1)'(1)$, $a_2 = (P_0^{\geq} \circ u_1)''(1)$, $\kappa = C\rho(P_0^{\geq})'(\rho)$ and $C = \sqrt{2\frac{P(\tau)}{P''(\tau)}}$. For $\rho_1 = 1$ we have $a_1 = \alpha = (P_0^{\geq} \circ u_1)'(\rho_1)$. Furthermore, for $\rho > 1$ and $\delta < 0$ we have

$$a_1 = -\frac{\delta_0^{\geq}}{\delta}, \quad a_2 = \frac{2\delta^2\delta_0^{\geq} - \delta_0^{\geq}P''(1) + \delta(P_0^{\geq})''(1)}{\delta^3}. \quad (111)$$

Proof. By Lemma 4.4.2 $\rho > 1$ implies $\delta \neq 0$ and $\rho = 1$ is equivalent to $\delta = 0$. In the first case $u_1(z)$ is regular at 1, which is why a truncated Taylor expansion gives

$$\begin{aligned} P_0^{\geq}(u_1(z)) &= P_0^{\geq}(u_1(1)) - \underbrace{(P_0^{\geq} \circ u_1)'(1)}_{=(P_0^{\geq})'(u_1(1))u_1'(1)}(1-z) \\ &\quad + \frac{(P_0^{\geq} \circ u_1)''(1)}{2}(1-z)^2 + o((1-z)^2). \end{aligned}$$

The derivative $u_1'(1)$ can be found by differentiating the kernel equation (51) and substituting $z = 1$:

$$u_1'(1) = -\frac{P(u_1(1))}{P'(u_1(1))} = -\frac{1}{P'(u_1(1))}.$$

Thus, for $u_1(1) = 1$ (which holds for $\delta < 0$) we get $u_1'(1) = -\frac{1}{\delta}$ and this gives $a_1 = -\frac{\delta_0^\geq}{\delta}$.

Next, we simplify $a_2 = (P_0^\geq \circ u_1)''(1)$ in the same manner. The second derivative is

$$(P_0^\geq \circ u_1)''(z) = (P_0^\geq)''(u_1(z))(u_1'(z))^2 + (P_0^\geq)'(u_1(z))u_1''(z).$$

Firstly, we twice implicitly differentiate the kernel equation and get

$$2P'(u_1(z))u_1'(z) + zP''(u_1(z))(u_1'(z))^2 + zP'(u_1(z))u_1''(z) = 0.$$

Secondly, as $\rho > 1$ this differentiation is legitimate at $z = 1$ and yields for $\delta < 0$ that

$$u_1''(1) = \frac{2\delta^2 - P''(1)}{\delta^3}.$$

Finally, we get under the conditions that $u_1(z)$ is defined at $z = 1$ and that $u_1(1) = 1$ that

$$a_2 = \frac{2\delta^2\delta_0^\geq - \delta_0^\geq P''(1) + \delta(P_0^\geq)''(1)}{\delta^3}.$$

In the second case, $\rho = 1$, the asymptotic given in (73) yields

$$P_0^\geq(u_1(z)) = P_0^\geq(1) - C(P_0^\geq)'(1)\sqrt{1-z} + \mathcal{O}(1-z),$$

and as $\rho = 1$, we have $\kappa = C(P_0^\geq)'(1)$. \square

With this lemma in mind we proceed in the derivation of $\mathbb{E}(Y_N)$:

- $\delta < 0$:

We start with the case of negative drift, $\delta < 0$. The branch $u_1(z)$ is well-defined in a neighborhood of 1 as $\rho > 1$ or $\rho_1 > 1$, respectively. The next computations are performed for ρ but are analogous for ρ_1 . A Taylor expansion at $z = 1$ gives

$$M(z) = 1 - \left(1 - P_0^\geq(1)\right) E'(1) + \mathcal{O}(1-z).$$

As a next step we compute $E'(z)$:

$$E'(z) = -\frac{1}{(1 - zP_0^\geq(u_1(z)))^2} \left(P_0^\geq(u_1(z)) + z(P_0^\geq \circ u_1)'(z) \right).$$

The first factor is equal to $E(z)^2$. Substituting $z = 1$ gives

$$E'(1) = -E(1)^2 \left(P_0^\geq(1) + a_1 \right),$$

where $a_1 := (P_0^\geq \circ u_1)'(1)$ from Lemma 4.6.3, and by (111) we know that $a_1 = -\delta_0^\geq/\delta$ for $\delta < 0$. Hence, we get the final result

$$\begin{aligned} \mathbb{E}(Y_N) &= 1 + E(1) \left(P_0^\geq(1) - \frac{\delta_0^\geq}{\delta} \right) + \mathcal{O}(\rho^{-N}) \\ &= E(1) \left(1 - \frac{\delta_0^\geq}{\delta} \right) + \mathcal{O}(\rho^{-N}). \end{aligned}$$

The error term is computed from the fact that $E(z)$ has radius of convergence ρ .

- $\delta = 0$:

In the case of drift $\delta = 0$, we know from Lemma 4.4.4 that in the absorption model only the subcritical case exists. In this case the asymptotic expansion for $E(z)$ is given in Theorem 4.2.2 and because of $\delta = 0$ we have $\rho = 1$. Therefore we get for $z \rightarrow 1$ the asymptotic expansion

$$M(z) = \frac{1 - \left(1 - P_0^\geq(1)\right) (E(1) - E(1)^2 \kappa \sqrt{1-z} + \mathcal{O}(1-z))}{1-z}.$$

As $\delta = 0$ Lemma 4.4.2 implies that $u_1(1) = 1$ and we get

$$M(z) = \frac{E(1)\kappa}{\sqrt{1-z}} + \mathcal{O}(1).$$

Inserting this result into (109) gives the final result for $N \rightarrow \infty$:

$$\begin{aligned} \mathbb{E}(Y_N) &= [z^N] E(1)\kappa(1-z)^{-3/2} + \mathcal{O}\left([z^N](1-z)^{-1}\right) \\ &= 2E(1)\kappa\sqrt{\frac{N}{\pi}} + \mathcal{O}(1). \end{aligned}$$

Note that $\delta = 0$ implies $\tau = 1$, which gives $\kappa = \sqrt{2/P''(1)}\delta_0^\geq$.

- $\delta > 0$:

For a positive drift $\delta > 0$ Lemma 4.4.2 implies that $u_1(1) < 1$, which is the reason why $1 - P_0^\geq(1) < E(1)$. Hence, there appear no cancellations. By Lemma 4.4.2 we have $\rho > 1$, which implies that $E(z)$ is analytic at $z = 1$. Therefore a Taylor expansion yields for $z \rightarrow 1$ the result

$$\begin{aligned} M(z) &= \frac{1 - \left(1 - P_0^\geq(1)\right) (E(1) + \mathcal{O}(1-z))}{1-z} \\ &= \frac{1 - \left(1 - P_0^\geq(1)\right) E(1)}{1-z} + \mathcal{O}(1). \end{aligned}$$

Applying (109) gives for $N \rightarrow \infty$:

$$\begin{aligned}\mathbb{E}(Y_N) &= [z^N] \frac{1 - (1 - P_0^{\geq}(1)) E(1)}{(1-z)^2} + \mathcal{O}([z^N](1-z)^{-1}) \\ &= \left(1 - (1 - P_0^{\geq}(1)) E(1)\right) N + \mathcal{O}(1).\end{aligned}$$

This proves Theorem 4.4.7.

Proof of Theorem 4.4.8

First some preliminary work and elementary results are derived. At the end of this section they are combined into the proof of Theorem 4.4.8.

It proves more convenient to use the following equivalent representation of (89)

$$F(z, u) = E(z) + E(z)z \frac{P_0^{\geq}(u) - P_0^{\geq}(u_1(z))}{1 - zP(u)}. \quad (112)$$

Differentiating with respect to u yields

$$\left. \frac{\partial}{\partial u} F(z, u) \right|_{u=1} = (P_0^{\geq})'(1) \frac{zE(z)}{1-z} + \underbrace{P'(1) (P_0^{\geq}(1) - P_0^{\geq}(u_1(z))) \frac{z^2 E(z)}{(1-z)^2}}_{H(z)}. \quad (113)$$

As a next step we apply the $[z^n]$ -operator to every term. The first term is a combination of previous results for $E(z)$. Its asymptotic behavior is a direct consequence of the Theorem 2.5.1 combined with the results from (76), (77) and (78).

Next we consider the second term $H(z)$. Its first factor is a composition of two generating functions with the two radii of convergence 1 and ρ . By Lemma 4.6.3 for $\rho = 1$ the constant term of the expansion of $P_0^{\geq}(1) - P_0^{\geq}(u_1(z))$ cancels. This also happens if $\delta < 0$ as we know from Lemma 4.4.2 that $u_1(1) = 1$. Remember that for $\delta > 0$ this cannot happen because $u_1(1) < 1$ and $P_0^{\geq}(u)$ is strictly monotonically increasing unless it is constant.

Combining these results we derive for $H(z)$ the following asymptotics for $z \rightarrow 1$ and $\rho > 1$:

$$H(z) = \begin{cases} \delta(P_0^{\geq}(1) - P_0^{\geq}(u_1(1))) \frac{z^2 E(z)}{(1-z)^2} + \mathcal{O}((1-z)^{-1}), & \text{for } \delta > 0, \\ 0, & \text{for } \delta = 0, \\ -\delta_0^{\geq} \frac{z^2 E(z)}{1-z} - \frac{\delta a_2}{2} E(z) + o(E(z)), & \text{for } \delta < 0. \end{cases} \quad (114)$$

Note that for $\rho = 1$ we also have $\delta = 0$ which means that $H(z) = 0$.

The last missing parts are the asymptotics of the quotient $\frac{E(z)}{(1-z)^2}$. We get the following generalization of Lemma 4.6.2, which gives the asymptotics of the terms $\frac{zE(z)}{(1-z)^\beta}$.

Lemma 4.6.4. *Let $E(z)$ be the generating function of excursions and $\beta \geq 0$ be a real number. Then, with the constants $\alpha = (P_0^\geq(u_1(z)))' \Big|_{z=\rho_1}$ and $\kappa = C\rho(P_0^\geq)'(\tau)$ the following asymptotics hold:*

$$[z^n] \frac{E(z)}{(1-z)^\beta} = \begin{cases} E(1) \frac{n^{\beta-1}}{\Gamma(\beta)} + \mathcal{O}(n^{\beta-2}), & \text{for } \rho > 1 \text{ or the supercr.} \\ & \text{case with } \rho_1 > 1, \\ \frac{1}{\alpha+1} \frac{n^\beta}{\Gamma(\beta+1)} + \mathcal{O}(n^{\beta-1}), & \text{for } \rho_1 = 1 \text{ and supercr.,} \\ \frac{1}{\kappa} \frac{n^{\beta-1/2}}{\Gamma(\beta+1/2)} + \mathcal{O}(n^{\beta-3/2}), & \text{for } \rho = 1 \text{ and critical,} \\ E(1) \frac{n^{\beta-1}}{\Gamma(\beta)} - & \text{for } \rho = 1 \text{ and subcritical.} \\ \frac{E(1)^2 \kappa n^{\beta-3/2}}{\Gamma(\beta-1/2)} + \mathcal{O}(n^{\beta-2}), & \end{cases} \quad (115)$$

Proof. The results are computed in a straightforward way using the results on excursions from (75). The proof follows similar lines to the one of Lemma 4.6.2 and is omitted. \square

Here Γ represents the Gamma-function. Important values for the final analysis are $\Gamma(n+1) = n!$ for $n \in \mathbb{N}$, $\Gamma(1/2) = \sqrt{\pi}$, $\Gamma(3/2) = \sqrt{\pi}/2$ and $\Gamma(5/2) = 3\sqrt{\pi}/4$.

Finally we can combine all previous results in order to prove Theorem 4.4.8. We start the discussion with the reflection model.

R1. For $\delta < 0$ only the supercritical case appears. Combining (113) and (114) we get

$$\frac{\partial}{\partial u} F(z, u) \Big|_{u=1} = \delta_0^\geq \frac{zE(z)}{1-z} - \delta_0^\geq \frac{z^2E(z)}{1-z} - \frac{\delta a_2}{2} z^2 E(z) + o(E(z)).$$

Collecting the first two terms and expanding z and z^2 into polynomials in $(1-z)$ yields

$$\begin{aligned} \frac{\partial}{\partial u} F(z, u) \Big|_{u=1} &= \delta_0^\geq E(z) (1 - (1-z)) \\ &\quad - \frac{\delta a_2}{2} E(z) (1 - 2(1-z) + (1-z)^2) + o(E(z)). \end{aligned}$$

Hence, it simplifies into

$$\frac{\partial}{\partial u} F(z, u) \Big|_{u=1} = \left(\delta_0^\geq - \frac{\delta a_2}{2} \right) E(z) + o(E(z)). \quad (116)$$

The last result only needs $\delta < 0$ as prerequisite. But now we see the surprising result that $\frac{\partial}{\partial u} F(z, u) \Big|_{u=1}$ is regular at $z = 1$ unless

$E(z)$ is singular there. (Note that this will also follow immediately from Lemma 4.4.9.) However, $E(z)$ can only be singular at $z = 1$ in the supercritical case of the reflection model, as in this case we derived $\rho_1 = 1$. Otherwise it always holds that $\rho > 1$ or $\rho_1 > 1$ for $\delta < 0$. Note that all calculations above were invariant of the used model.

Let us now focus on the reflection model. Then (76) becomes

$$E(z) \sim \frac{1}{\alpha + 1} \frac{1}{1 - z}.$$

Thus, by singularity analysis we get for large n that (116) is equal to

$$\mathbb{E}(X_n) = \frac{\delta_0^{\geq} - \delta a_2/2}{\alpha + 1} + o(1),$$

which means that the expected value for the final altitude converges in this case to a constant value. In the case of $\delta < 0$ we can use the simplifications (111) for a_2 and arrive at the final result

$$\mathbb{E}(X_n) = \frac{\delta_0^{\geq} P''(1) - \delta(P_0^{\geq})''(1)}{2\delta(\delta - \delta_0^{\geq})} + o(1).$$

R2. Next we treat the case $\delta = 0$ which means $\rho = 1$. Here $H(z)$ plays no role. Therefore we get directly from (115) that

$$\begin{aligned} \mathbb{E}(X_n) &= \delta_0^{\geq} [z^n] \frac{zE(z)}{1-z} = \delta_0^{\geq} [z^n] \left(\frac{E(z)}{1-z} - E(z) \right) \\ &= \frac{2\delta_0^{\geq}}{\kappa} \sqrt{\frac{n}{\pi}} + \mathcal{O}\left(\frac{1}{\sqrt{n}}\right) \\ &= \sqrt{\frac{2P''(1)n}{\pi}} + \mathcal{O}\left(\frac{1}{\sqrt{n}}\right). \end{aligned}$$

The last equality follows from $\kappa = \delta_0^{\geq} \sqrt{2/P''(1)}$ for $\rho = 1$.

R3. Finally, let us deal with $\delta > 0$. This case encloses all 3 other cases concerning the critical behavior, but they all lead to the same result. The reflection model simplifies $H(z)$ from (114) into

$$\delta \left(1 - P_0^{\geq}(u_1(1))\right) E(z) \left(\frac{1}{(1-z)^2} - \frac{2}{1-z} + 1 \right) + \mathcal{O}((1-z)^{-1}).$$

In a similar manner as before we expand $E(z)$ at the regular value $z = 1$ by a Taylor expansion. Inserting this result into the above equation and using that

$$E(1) = \frac{1}{1 - P_0^{\geq}(u_1(1))},$$

we get

$$H(z) = \frac{\delta}{(1-z)^2} + \mathcal{O}((1-z)^{-1}).$$

Hence,

$$\mathbb{E}(X_n) = \delta n + \mathcal{O}(1),$$

as by (115) the first term in (113) is in all three cases of order $\mathcal{O}(1)$.

Before we deal with the absorption model, remember that we need to consider the total number of meanders which had been derived in Section 4.4. The expected value (91) is computed by a normalization by the the total number of meanders determined by Theorem 4.4.6. This value is non-trivial in the absorption model and summarized in Table 10. Furthermore, by Lemma 4.4.3 we have $\rho_1 > 1$ in all cases.

A1. We start again with $\delta < 0$. As $E(z)$ is regular at $z = 1$, we also see by (116) that for $z \rightarrow 1$ we have

$$\left. \frac{\partial}{\partial u} F(z, u) \right|_{u=1} = \left(\delta_0^{\geq} - \frac{\delta a_2}{2} \right) E(z) + \mathcal{O}(E(z)(1-z)),$$

is regular at $z = 1$. Hence the singularity is located at $z = \rho$. A rearrangement of (113) gives

$$\begin{aligned} \left. \frac{\partial}{\partial u} F(z, u) \right|_{u=1} &= E(z)G(z), \\ G(z) &:= \left(\frac{\delta_0^{\geq} z}{1-z} + \delta \left(P_0^{\geq}(1) - P_0^{\geq}(u_1(z)) \right) \frac{z^2}{(1-z)^2} \right) \quad (117) \end{aligned}$$

where $G(z)$ is regular at $z = 1$. Observe that $G(z)$ includes $u_1(z)$ and is therefore singular at ρ .

a) *supercritical case*

In the supercritical case $E(z)$ becomes singular at $1 < \rho_1 < \rho$. Hence, $G(z)$ is regular at ρ_1 and we use $G(z) = G(\rho_1) + \mathcal{O}(1 - z/\rho_1)$. This gives

$$\left. \frac{\partial}{\partial u} F(z, u) \right|_{u=1} = \frac{\gamma G(\rho_1)}{1 - z/\rho_1} + \mathcal{O}(1).$$

Combining this result with the total number of meanders from Table 10 implies

$$\begin{aligned} \mathbb{E}(X_n) &= \frac{[z^n] \left. \frac{\partial}{\partial u} F(z, u) \right|_{u=1}}{[z^n] F(z, 1)} \\ &\sim \frac{G(\rho_1) \gamma \rho_1^{-n}}{\gamma \rho_1^{-n+1} / (E(1)(\rho_1 - 1))} \\ &= \left(1 - \frac{1}{\rho_1} \right) E(1)G(\rho_1). \end{aligned}$$

b) *critical case*

Let us first consider $G(z)$ at $z = \rho$ by combining it with the singular expansion of $u_1(z)$ from (73) we get for $z \rightarrow \rho$

$$P_0^{\geq}(u_1(z)) = P_0^{\geq}(\tau) - (P_0^{\geq})'(\tau)C\sqrt{1-z/\rho} + \mathcal{O}(1-z/\rho).$$

Next, we insert this expansion into $G(z)$ and apply Theorem 2.5.1 to get the asymptotics of the second term. The first term is regular at $z = \rho$. We get for $z \rightarrow \rho$

$$\begin{aligned} G(z) &= \frac{\delta_0^{\geq}\rho}{1-\rho} + \frac{\delta\rho^2 \left(P_0^{\geq}(1) - P_0^{\geq}(\tau) + C(P_0^{\geq})'(\tau)\sqrt{1-z/\rho} \right)}{(1-\rho)^2} \\ &\quad + \mathcal{O}(1-z/\rho) \\ &= G(\rho) + \frac{\delta\kappa\rho}{(1-\rho)^2}\sqrt{1-z/\rho} + \mathcal{O}(1-z/\rho) \end{aligned} \quad (118)$$

Hence, we get by (77) that

$$\begin{aligned} \frac{\partial}{\partial u} F(z, u) \Big|_{u=1} &= \left(\frac{1}{\kappa\sqrt{1-z/\rho}} + \mathcal{O}\left(\sqrt{1-z/\rho}\right) \right) \times \\ &\quad \left(G(\rho) + \mathcal{O}\left(\sqrt{1-z/\rho}\right) \right) \\ &= \frac{G(\rho)}{\kappa\sqrt{1-z/\rho}} + \mathcal{O}(1). \end{aligned}$$

Using again Table 10 we get the final result

$$\mathbb{E}(X_n) \sim \frac{G(\rho)\rho^{-n}/(\kappa\sqrt{\pi n})}{\rho^{-n+1}/(\kappa E(1)(\rho-1)\sqrt{\pi n})} = \left(1 - \frac{1}{\rho}\right) E(1)G(\rho).$$

c) *subcritical case*

Here, again $E(z)$ and $u_1(z)$ are singular at $z = \rho$. Hence, we use the expansion (118) again, but now with one more term. Combining it with (78) we derive

$$\begin{aligned} \frac{\partial}{\partial u} F(z, u) \Big|_{u=1} &= \left(E(\rho) - E(\rho)^2\kappa\sqrt{1-z/\rho} \right) \times \\ &\quad \left(G(\rho) + \frac{\delta\kappa\rho}{(1-\rho)^2}\sqrt{1-z/\rho} \right) + \mathcal{O}(1-z/\rho) \\ &= E(\rho)G(\rho) - E(\rho)^2\kappa \left(G(\rho) - \frac{\delta\rho(1-\lambda)}{(1-\rho)^2} \right) \times \\ &\quad \sqrt{1-z/\rho} + \mathcal{O}(1-z/\rho), \end{aligned}$$

where we used that $E(\rho) = \frac{1}{1-\lambda}$ with $\lambda = \frac{P_0^{\geq}(\tau)}{P(\tau)}$. This gives for the expected value

$$\begin{aligned} \mathbb{E}(X_n) &\sim \frac{E(\rho)^2\kappa \left(G(\rho) - \frac{\delta\rho(1-\lambda)}{(1-\rho)^2} \right) \rho^{-n}/(2\sqrt{\pi n^3})}{E(\rho)^2\kappa\rho^{-n+1}/(2E(1)(\rho-1)\sqrt{\pi n^3})} \\ &= \left(1 - \frac{1}{\rho}\right) E(1) \left(G(\rho) - \frac{\delta\rho(1-\lambda)}{(1-\rho)^2} \right). \end{aligned}$$

A2. For $\delta = 0$ only the subcritical case exists in the absorption model. Additionally we know that the singularity appears at $\rho = 1$ and as in the reflection model, $H(z)$ plays no role in $\mathbb{E}(X_n)$. We get from (115) or (78) applied to (113) that

$$\begin{aligned} [z^n] \frac{\partial}{\partial u} F(z, u) \Big|_{u=1} &= \delta_0^\geq [z^n] \left(\frac{E(z)}{1-z} - E(z) \right) \\ &= \delta_0^\geq E(1) - \delta_0^\geq E(1)^2 \frac{\kappa}{\sqrt{\pi n}} + \mathcal{O}\left(\frac{1}{n}\right). \end{aligned}$$

Therefore, by Table 10 we arrive at

$$\begin{aligned} \mathbb{E}(X_n) &= \frac{\delta_0^\geq}{\kappa} \sqrt{\pi n} - \delta_0^\geq E(1) + \mathcal{O}\left(\frac{1}{\sqrt{n}}\right) \\ &= \sqrt{\frac{P''(1)\pi n}{2}} - \delta_0^\geq E(1) + \mathcal{O}\left(\frac{1}{\sqrt{n}}\right), \end{aligned}$$

where the simplification $\kappa = \delta_0^\geq \sqrt{2/P''(1)}$ for $\rho = 1$ was used.

A3. The case $\delta > 0$ is analogous to the reflection model, as it gives the same result for all three critical arrangements and we can mimic its derivation. By (114) $H(z)$ for $z \rightarrow 1$ given by

$$H(z) = \delta(P_0^\geq(1) - P_0^\geq(u_1(1))) \frac{z^2 E(z)}{(1-z)^2} + \mathcal{O}((1-z)^{-1}).$$

As $\delta > 0$ we also know that $\rho > 1$, which is why 1 is the dominant singularity of $H(z)$. By Theorem 2.5.1 we get

$$H(z) = \delta(P_0^\geq(1) - P_0^\geq(u_1(1))) \frac{E(1)}{(1-z)^2} + \mathcal{O}((1-z)^{-1}).$$

Hence, with Table 10 or more precisely with expression (108) we get

$$\mathbb{E}(X_n) = \frac{\delta(P_0^\geq(1) - P_0^\geq(u_1(1)))E(1)n}{P_0^\geq(1) - P_0^\geq(u_1(1))E(1)} + \mathcal{O}(1) = \delta n + \mathcal{O}(1).$$

This proves Theorem 4.4.8.

Proof of Theorem 4.4.10

1. Let us start with a negative drift $\delta < 0$. In this case the Continuity Theorem 2.3.1 will yield a discrete law in all cases. The functions $p_n(u)$ are given by $f_n(u)$ in the reflection model and by $f_n(u)/[z^n]M(z)$ in the absorption model (compare Definition 4.1.4). As a first step we have to make these explicit. For this purpose we fix $u \in (0, \tau)$ and treat it as a parameter of $F(z, u)$. From Lemma 4.4.9 we know that it is singular at $z = \rho$

or $z = \rho_1$. Without loss of generality we assume the singularity at $z = \rho$. With that in mind we want to use singularity analysis to derive the asymptotic expansion of $f_n(u) = [z^n]F(z, u)$. First, we expand the denominator at $z = \rho$ and assume $z \in U_\varepsilon(\rho)$ for suitable $\varepsilon < 1$, such that $\frac{1}{1-zP(u)}$ is a convergent power series in z :

$$\begin{aligned} \frac{1}{1-zP(u)} &= \frac{1}{(1-\rho P(u)) + P(u)(\rho-z)} \\ &= \frac{1}{1-\rho P(u)} \frac{1}{1 - \frac{P(u)}{1-\rho P(u)}(z-\rho)} \\ &= \frac{1}{1-\rho P(u)} \left(1 + \frac{\rho P(u)}{1-\rho P(u)}(1-z/\rho) + \mathcal{O}((1-z/\rho)^2) \right). \end{aligned}$$

Combining this with the numerator gives

$$\begin{aligned} F(z, u) &= \frac{1}{1-\rho P(u)} \left[1 + \frac{\rho P(u)}{1-\rho P(u)}(1-z/\rho) + \mathcal{O}((1-z/\rho)^2) \right] \\ &\quad \times \left[1 + \left(P_0^\geq(u) - P(u) \right) \rho(1 - (1-z/\rho))E(z) \right]. \quad (119) \end{aligned}$$

In anticipation of the limit function we define the following function, which will play a role in the next formulae and can be easily recognized in (119):

$$g(u) := \rho \frac{P_0^\geq(u) - P(u)}{1 - \rho P(u)}.$$

The asymptotics of $E(z)$ have been derived in Theorem 4.2.2. Thus, the leading terms with respect to z in the three cases are given by

$$F(z, u) = \begin{cases} \gamma g(u) \frac{1}{1-z/\rho_1} + \mathcal{O}(1), & \text{supercr.: } P(\tau) < P_0^\geq(\tau), \\ \frac{1}{\kappa} g(u) \frac{1}{\sqrt{1-z/\rho}} + \mathcal{O}(1), & \text{critical: } P(\tau) = P_0^\geq(\tau), \\ c_0 - \kappa E(\rho)^2 g(u) \sqrt{1-z/\rho} \\ + \mathcal{O}(1-z/\rho), & \text{subcr.: } P(\tau) > P_0^\geq(\tau). \end{cases}$$

The constant $c_0 \in \mathbb{R}$ can be directly computed by (119). Before we extract $f_n(u)$ we take a closer look on the error encoded by the $\mathcal{O}(\cdot)$ -term. Therefore, we return to the proof of Theorem 4.2.2.

- In the supercritical case $z = \rho_1$ is a simple pole of $E(z)$. Thus, $(1-z/\rho_1)E(z)$ is analytic at ρ_1 and the next singularity is found at ρ where $u_1(z)$ becomes singular. Hence, the remaining part is regular inside a disc with radius ρ around the origin.

- In the critical case the $\mathcal{O}(1)$ -term encodes a Puiseux-series in $\sqrt{1 - z/\rho}$ with non-negative exponents.
- In the subcritical case the $\mathcal{O}(1 - z/\rho)$ -term represents a Puiseux-series also in $\sqrt{1 - z/\rho}$ where all exponents are greater or equal 1.

This discussion enables us to extract the asymptotic form of the coefficients with respect to z in order to gain $f_n(u)$. A table of such standard functions is for example given in [85, Figure VI.5].

$$f_n(u) = \begin{cases} \gamma g(u) \rho_1^{-n} + \mathcal{O}(\rho^{-n}), & \text{supercr. case: } P(\tau) < P_0^\geq(\tau), \\ \frac{1}{\kappa} g(u) \frac{\rho^{-n}}{\sqrt{\pi n}} + \mathcal{O}\left(\frac{\rho^{-n}}{\sqrt{n^3}}\right), & \text{critical case: } P(\tau) = P_0^\geq(\tau), \\ \kappa E(\rho)^2 g(u) \frac{\rho^{-n}}{2\sqrt{\pi n^3}} \\ + \mathcal{O}\left(\frac{\rho^{-n}}{\sqrt{n^5}}\right), & \text{subcr. case: } P(\tau) > P_0^\geq(\tau). \end{cases} \quad (120)$$

In the reflection model the $f_n(u)$ functions are the $p_n(u)$ functions of Theorem 2.3.1. Due to Lemma 4.4.5 the only possible case for $\delta < 0$ is the supercritical one. Furthermore, because of Lemma 4.4.3 the singularity is explicitly known as $\rho_1 = 1$. Therefore, we get from (120) the following convergence:

$$\lim_{n \rightarrow \infty} f_n(u) = \gamma g(u), \quad \text{pointwise for each } u \in (0, 1).$$

The limit is indeed a probability generating function. We show that $\gamma g(1) = 1$. By L'Hospital's rule one gets $\lim_{u \rightarrow 1} g(u) = 1 - \delta_0^\geq / \delta$. By (111) we see that $\gamma = 1 / (\alpha \rho_1^2 + 1) = 1 / (1 - \delta_0^\geq / \delta)$ and the claim holds.

In the absorption model we need to normalize the functions $f_n(u)$ by $[z_n]M(z)$ from Theorem 4.4.6. It is interesting that this leads to the same leading term in all cases for the asymptotic expansion, yet only the error terms are different:

$$\frac{f_n(u)}{[z^n]M(z)} = \begin{cases} E(1) \left(1 - \frac{1}{\rho_1}\right) g(u) + \mathcal{O}\left(\left(\frac{\rho}{\rho_1}\right)^{-n}\right), & \text{supercr.}, \\ E(1) \left(1 - \frac{1}{\rho}\right) g(u) + \mathcal{O}\left(\frac{1}{n}\right), & \text{critical}, \\ E(1) \left(1 - \frac{1}{\rho}\right) g(u) + \mathcal{O}\left(\frac{1}{n}\right), & \text{subcr.} \end{cases}$$

These correspond to the $p_n(u)$ functions of Theorem 2.3.1. Note that these asymptotic expansions are valid for $u \in (0, \tau)$, hence $(0, \tau) \cap (0, 1)$ represents the accumulations points inside the unit disc wherein the following pointwise convergence holds:

$$\lim_{n \rightarrow \infty} \frac{f_n(u)}{[z^n]M(z)} = E(1) \left(1 - \frac{1}{\rho_1}\right) g(u), \quad \text{for each } u \in (0, \tau).$$

Here again, the limit is a probability generating function. By Lemma 4.4.2 it holds for $\delta < 0$ that $u_1(1) = 1$, and therefore $E(1) = 1/(1 - P_0^{\geq}(1))$. But this is exactly the numerator of $g(u)$ for $u = 1$, as $g(1) = \frac{1 - P_0^{\geq}(1)}{1 - 1/\rho_1}$. Obviously, the denominator is canceled by the other factor and we get

$$E(1) \left(1 - \frac{1}{\rho_1}\right) g(1) = 1.$$

Thus, by the Continuity Theorem 2.3.1 we conclude the existence of a discrete limit law with the above limit distributions.

2. Next, assume a positive drift $\delta > 0$. For this case the Quasi-powers Theorem 2.3.2 will give the answer, to wit after standardization a Gaussian limit law will emerge. The key is to isolate the asymptotic structure (28) for large powers of z in a neighborhood of $u = 1$. We start with the extraction of the n -th coefficient in z of $F(z, u)$. First, note that by Lemma 4.4.1 and Lemma 4.4.3 we have $\rho > 1$ or $\rho_1 > 1$, respectively, as $\delta > 0$. Therefore, without loss of generality all following computations are performed for ρ only. We will see that the critical behavior plays no role in this case.

As a first step we rewrite (89) as

$$F(z, u) = \frac{1}{1 - zP(u)} - \frac{P(u) - P_0^{\geq}(u)}{P(u)} \left(\frac{E(z)}{1 - zP(u)} - E(z) \right).$$

Next, we want to apply the $[z^n]$ -operator. For the second term $\frac{E(z)}{1 - zP(u)}$ we need a similar result as the one of Lemma 4.6.2 where the singularity of the denominator is not at 1 but at $1/P(u)$. However, it does not need to be as accurate.

Note that $1/P(u)$ is strictly smaller than ρ for $u \neq \tau$. The structure of equation (28) must hold in a neighborhood of $u = 1$. By Lemma 4.4.2 we know that $\tau < 1$ for $\delta > 0$. Hence, we can choose a neighborhood of $u = 1$ which does not include τ in which $1/P(u)$ is strictly smaller than ρ . If we are dealing with the supercritical case, we also know that $1 < \rho_1 < \rho$. As $P(1) = 1$ and P is continuous we can also choose a suitable neighborhood of $u = 1$ on which $1/P(u) < \rho_1$. Due to that reasoning $E(z)$ is always regular at $1/P(u)$ for a suitable domain around $u = 1$. Hence, an application of Theorem 2.5.1 gives the asymptotics.

The error term is of order $\mathcal{O}(\rho^{-n})$ because the singularity of the term at $1/P(u)$ is a simple pole which does not exist in the error any more. Therefore the next singularity is the significant

one, which is the one of $E(z)$ at ρ or ρ_1 , respectively (compare Theorem 4.2.2). Then we get

$$[z^n] \frac{E(z)}{1 - zP(u)} = E\left(\frac{1}{P(u)}\right) P(u)^n + \mathcal{O}(\rho^{-n}).$$

Due to the same reasoning as above $[z^n]E(z)$ is by Theorem 4.2.2 of the order $\mathcal{O}(\rho^{-n})$. We derive for u in a suitable neighborhood of $u = 1$

$$\begin{aligned} f_n(u) &= P(u)^n - \frac{P(u) - P_0^{\geq}(u)}{P(u)} \left(E\left(\frac{1}{P(u)}\right) P(u)^n + \mathcal{O}(\rho^{-n}) \right) \\ &= \left(1 - \left(1 - \frac{P_0^{\geq}(u)}{P(u)} \right) E\left(\frac{1}{P(u)}\right) \right) P(u)^n (1 + \mathcal{O}(\rho^{-n})). \end{aligned} \quad (121)$$

Let us continue in the *reflection model*. There equation (121) resembles the desired form of equation (28). We have

$$\begin{aligned} A(u) &= \left(1 - \left(1 - \frac{P_0^{\geq}(u)}{P(u)} \right) E\left(\frac{1}{P(u)}\right) \right), \\ B(u) &= P(u), \\ \beta_n &= n, \\ \kappa_n &= \rho^n \text{ or } \kappa_n = \rho_1^n. \end{aligned}$$

Both are probability generating functions and therefore fulfill $A(1) = B(1) = 1$. Furthermore the variability condition (29) obviously holds for $B(u)$, as it is the probability generating function (or in particular polynomial) of a single step at altitude $k > 0$. To make that clear, consider S to be the random variable that denotes the next jump at altitude $k > 0$, then we have $P(u) = \mathbb{E}(u^S)$. Hence, $P'(1) = \mathbb{E}(S)$ and $P''(1) = \mathbb{E}(S(S-1))$ which is why the variability condition is equivalent to

$$\mathbb{V}(S) = \mathbb{E}(S(S-1)) + \mathbb{E}(S) - \mathbb{E}(S)^2 \neq 0.$$

If this equation evaluated to 0, it would imply a deterministic random variable S , i.e. the existence of only one single step with probability 1. We exclude this trivial case.

Hence, all conditions of Theorem 2.3.2 are fulfilled and it implies after standardization a Gaussian limit law. The expected value and the variance are asymptotically given as

$$\begin{aligned} \mathbb{E}(X_n) &\sim \delta n, \\ \mathbb{V}(X_n) &\sim (P''(1) + \delta - \delta^2)n. \end{aligned}$$

Remark that the expected value fits with the results from Table 14 for $\delta > 0$.

In the *absorption model* we have to normalize the functions $f_n(u)$ by the total number of meanders given in Theorem 4.4.6. Then (121) transforms into

$$f_n(u) = \frac{1 - \left(1 - \frac{P_0^{\geq}(u)}{P(u)}\right) E\left(\frac{1}{P(u)}\right)}{1 - \left(1 - P_0^{\geq}(1)\right) E(1)} \cdot P(u)^n \left(1 + \mathcal{O}\left(\frac{1}{\rho^n}\right)\right).$$

Hence, the parameters from the reflection model stay the same, only $A(u)$ changes into

$$A(u) = \frac{1 - \left(1 - \frac{P_0^{\geq}(u)}{P(u)}\right) E\left(\frac{1}{P(u)}\right)}{1 - \left(1 - P_0^{\geq}(1)\right) E(1)}.$$

This is also a probability generating function as $A(1) = 1$. Therefore, we get the same result as above with the same asymptotics for the expected value and the variance.

3. Finally, assume $\delta = 0$. In this case we will show that the limit law is in the absorption model governed by a Rayleigh distribution, but in the reflection model given by a half-normal distribution, cf. [179].

In the *absorption model* we are going to use Theorem 2.3.8. In order to do that we need to satisfy the conditions of Hypothesis [H]. The power series $c(z, u)$ is in our case represented by $F(z, u)$. The power series $F(z, 1)$, which is the generating function of meanders, has radius of convergence $\rho = 1$. Furthermore, we need a local representation of the kind

$$\frac{1}{F(z, u)} = g(z, u) + h(z, u) \sqrt{1 - \frac{z}{\rho(u)}}$$

for $|u - 1| < \varepsilon$ and $|z - \rho(u)| < \varepsilon$, $\arg(z - \rho(u)) \neq 0$, where $\varepsilon > 0$ fixed. In our case we have that $\rho(u) = 1/P(u)$, and that the singularity in the variable z arises from the square root singularity of $u_1(z)$.

Let us derive this local representation. From (72) and the kernel equation (52) we deduce

$$F(z, u)^{-1} = \frac{(P(u_1(z)) - P(u)) \left(1 - \frac{P_0^{\geq}(u_1(z))}{P(u_1(z))}\right)}{P(u_1(z)) - P_0^{\geq}(u_1(z)) - P(u) + P_0^{\geq}(u)}.$$

Next, we substitute $x = u_1(z)$ and get the bivariate function

$$G(x, u) = \frac{P(x) - P(u)}{\underbrace{(P(x) - P_0^{\geq}(x)) - (P(u) - P_0^{\geq}(u))}_{=:S(x,u)}} \left(1 - \frac{P_0^{\geq}(x)}{P(x)}\right),$$

such that $F(z, u)^{-1} = G(u_1(z), u)$. Note that the function $S(x, u)$ is symmetric in its arguments. We are interested in a neighborhood of 1 for u and z , respectively, as $u(1) = 1$. Note that this is a rational function in x and u , as $P(u)$ and $P_0^{\geq}(u)$ are (Laurent) polynomials in u . Hence, its possible singularities are given by the roots of the denominator.

There exists an $\varepsilon > 0$, such that $x = u$ are the only possible singularities of $G(x, u)$ for $|u - 1| < \varepsilon$ and $|x - 1| < \varepsilon$. This holds, as $\varphi(x) := P(x) - P_0^{\geq}(x)$ is a Laurent polynomial and $\varphi'(1) = -(P_0^{\geq})'(1) < 0$. Hence, φ is one-to-one in a small enough neighborhood of 1 which can also be chosen such that $\varphi'(x) \neq 0$. However, in the case $x = u$ the numerator of S also becomes 0 and this singularity is canceled:

$$\begin{aligned} \lim_{u \rightarrow x} S(x, u) &= \lim_{x \rightarrow u} \frac{\frac{P(x)-P(u)}{x-u}}{\frac{P(x)-P(u)}{x-u} - \frac{P_0^{\geq}(x)-P_0^{\geq}(u)}{x-u}} = \frac{P'(x)}{P'(x) - (P_0^{\geq})'(x)}, \\ G(x, x) &= \frac{P'(x)}{P'(x) - (P_0^{\geq})'(x)} \left(1 - \frac{P_0^{\geq}(x)}{P(x)} \right). \end{aligned} \tag{122}$$

Therefore, $G(x, u)$ is an analytic function on the chosen neighborhood, as the denominator does not vanish. Hence, we can use the Taylor expansion of

$$G(x, u) = \sum_{\ell, k \geq 0} g_{lk} (x - 1)^\ell (u - 1)^k,$$

where $g_{00} = 0$ and $g_{10} = g_{01} = -P''(1) \frac{1-P_0^{\geq}(1)}{2\delta_0^{\geq}} = -\frac{1}{E(1)C\kappa}$ (for more details see Remark 17) and the fact that $u_1(z)$ has a local representation of the kind

$$u_1(z) = a(z) - b(z)\sqrt{1 - z},$$

where $a(z)$ and $b(z)$ are analytic functions around $z = 1$ with $a(1) = 1$ and $b(1) = C$, to see that $G(u_1(z), u)$ has a local representation of the kind

$$G(u_1(z), u) = g(z, u) + h(z, u)\sqrt{1 - z},$$

where $g(1, 1) = g_{00} = 0$ and $h(1, 1) = -g_{10}b(1) = \frac{1}{E(1)\kappa} > 0$. The technical conditions of hypothesis [H] are also met, as we are dealing with a rational function. Finally, due to $g_u(1, 1) = g_{01} = -\frac{1}{E(1)C\kappa} < 0$ we can apply Theorem 2.3.8 and get a Rayleigh limit law. The parameter ϑ is equal to $1/P''(1)$. Hence, the expected value and the variance are asymptotically given as

$$\begin{aligned} \mathbb{E}(X_n) &= \sqrt{\frac{P''(1)\pi n}{2}} + \mathcal{O}(1), \\ \mathbb{V}(X_n) &= \left(2 - \frac{\pi}{2} \right) P''(1)n + \mathcal{O}(\sqrt{n}). \end{aligned}$$

Remark that the expected value fits with the results from Table 15 for $\delta = 0$.

In the *reflection model* we are going to use Fréchet and Shohat's Theorem 2.3.10 to prove convergence by moments to a half-normal distribution. First, note that the k -th factorial moments $\mathbb{E}((X)_k)$ ($(X)_k$ is the falling factorial defined by $(X)_k := X(X - 1) \cdots (X - k + 1)$) and the k -th moment $\mathbb{E}(X^k)$ are asymptotically equivalent. The falling factorial moments are easily computed via the respective derivatives of the involved probability generating function, i.e. in our case we have

$$\mathbb{E}(X_n^k) \sim \mathbb{E}((X_n)_k) = [z^n] \frac{\partial^k}{\partial u^k} F(z, u) \Big|_{u=1},$$

as $F(z, u)$ given by (89) is already a probability generating function in the reflection model. We start by determining the structure of the factorial moments. Therefore, we take a closer look on the structure of $F(z, u)$ with regards to u and interpret z as a parameter. In (89) we see that the general structure is

$$F(z, u) = \frac{Q_1(u)}{1 - zP(u)} + E(z)z \frac{Q_2(u)}{1 - zP(u)}, \tag{123}$$

where $Q_1(u) = 1$ and $Q_2(u) = P_0^{\geq}(u) - P(u)$. Thus the governing structure is $Q(u)/(1 - zP(u))$. Hence, let us investigate the derivatives of this term. We get

$$\frac{\partial^k}{\partial u^k} \frac{Q(u)}{1 - zP(u)} = \sum_{i=0}^k \binom{k}{i} \left(\frac{\partial^{k-i}}{\partial u^{k-i}} Q(u) \right) \left(\frac{\partial^i}{\partial u^i} \frac{1}{1 - zP(u)} \right). \tag{124}$$

Notice that z only occurs in the second derivative. Hence, its asymptotic behavior will depend on this term. The i -th derivative evaluated at $u = 1$ has the following structure

$$\frac{\partial^i}{\partial u^i} \frac{1}{1 - zP(u)} \Big|_{u=1} = \sum_{j=0}^i c_{i,j} \frac{z^j}{(1 - z)^{j+1}},$$

where the $c_{i,j}$ are constants. This reveals that the dominant contribution in terms of z comes from the highest non-vanishing derivative of this term.

Due to $\delta = 0$ we have

$$\begin{aligned} \frac{1}{1 - zP(u)} &= \frac{1}{1 - z - z \frac{P''(1)}{2} (u - 1)^2 + \mathcal{O}((u - 1)^3)} \\ &= \frac{1}{1 - z} \sum_{\ell \geq 0} \left(\frac{P''(1)}{2} \frac{z(u - 1)^2}{1 - z} + \mathcal{O} \left(\frac{(u - 1)^3}{1 - z} \right) \right)^\ell, \end{aligned}$$

where the sum converges absolutely for $|z| < P(|u|)$. Next, we distinguish between an even and an odd value of i and get

$$\frac{\partial^i}{\partial u^i} \frac{1}{1 - zP(u)} \Big|_{u=1} = \begin{cases} P''(1)^\ell \frac{(2\ell)!}{2^\ell} \frac{z^\ell}{(1-z)^{\ell+1}} & \text{for } i = 2\ell, \\ +\mathcal{O}((1-z)^{-\ell}), \\ \mathcal{O}((1-z)^{-(\ell+1)}), & \text{for } i = 2\ell + 1. \end{cases}$$

The odd case derives from the observation that the lowest possible exponent for $(1-z)$ is created by $\ell - 1$ factors of the ones involving $(u-1)^2$ plus one from the ones involving $(u-1)^3$. Note that these values can be computed, but we won't need them in more detail.

Finally, we are able to compute the asymptotics of the k -th moments. Due to the last result we distinguish between even and odd moments.

Even moments ($k = 2\ell$):

From (123) we see that

$$\begin{aligned} \mathbb{E}(X_n^{2\ell}) &= [z^n] \left(\underbrace{(Q_1(1) + Q_2(1)zE(z))}_{=1} \left(\frac{P''(1)^\ell (2\ell)! z^\ell}{2^\ell (1-z)^{\ell+1}} \right. \right. \\ &\quad \left. \left. + \mathcal{O}((1-z)^{-\ell}) \right) + \mathcal{O}\left(\frac{E(z)}{(1-z)^\ell}\right) \right) \\ &= \frac{(2\ell)!}{2^\ell \ell!} (P''(1)n)^\ell + \mathcal{O}(n^{\ell-1/2}), \end{aligned}$$

where $Q_2(1) = 0$ because we are in the case of the reflection model with $P_0^{\geq}(1) = 1$. The last error term in the first line represents all other terms of (124). For the computation of the error term in the last line we applied (115).

Odd moments ($k = 2\ell + 1$):

In this case we need to consider the last two summands in (123) to get

$$\begin{aligned} \mathbb{E}(X_n^{2\ell+1}) &= [z^n] \left(\underbrace{(Q'_1(1) + Q'_2(1)zE(z))}_{=0} \left((2\ell+1) \frac{P''(1)^\ell (2\ell)! z^\ell}{2^\ell (1-z)^{\ell+1}} \right. \right. \\ &\quad \left. \left. + \mathcal{O}((1-z)^{-\ell}) \right) + \underbrace{(Q_1(1) + Q_2(1)zE(z))}_{=1} \mathcal{O}((1-z)^{-(\ell+1)}) \right. \\ &\quad \left. + \mathcal{O}\left(\frac{E(z)}{(1-z)^\ell}\right) \right). \end{aligned}$$

The first term is the one of index $i = 2\ell$ in (123). From (115) we deduce that only this term matters asymptotically. The dom-

inant error term comes from the term with index $i = 2\ell + 1$ and is of order $\mathcal{O}(n^{-\ell})$. Thus, we get

$$\begin{aligned} \mathbb{E}(X_n^{2\ell+1}) &= \delta_0^{\geq} P''(1)^\ell \frac{(2\ell + 1)!}{2^\ell} [z^n] \frac{z^{\ell+1} E(z)}{(1-z)^{\ell+1}} + \mathcal{O}(n^\ell) \\ &= 2^\ell \ell! \sqrt{\frac{2}{\pi}} \sqrt{(P''(1)n)^{2\ell+1}} + \mathcal{O}(n^\ell). \end{aligned}$$

In the last equality we used again (115) and the Gamma duplication formula $\Gamma(x)\Gamma(x + \frac{1}{2}) = 2^{1-2x} \sqrt{\pi} \Gamma(2x)$.

Normalized random variable:

From the last two results we see that the normalized random variables $Y_n := \frac{X_n}{\sqrt{P''(1)n}}$ possess the following moments:

$$\mathbb{E}(Y_n^k) = \begin{cases} \frac{(2\ell)!}{2^\ell \ell!} + \mathcal{O}(n^{-1/2}), & \text{for } k = 2\ell, \\ \sqrt{\frac{2}{\pi}} 2^\ell \ell! + \mathcal{O}(n^{-1/2}), & \text{for } k = 2\ell + 1. \end{cases}$$

Hence, by Fréchet and Shohat’s Theorem 2.3.10 we get convergence to a half-normal distribution Y , which possesses exactly the above moments, cf. [4, Chapter 2.2.2] or for explicit moments [179, Chapter 34.2].

This ends the proof of Theorem 4.4.6.

Remark 17. We briefly sketch the computations of the first Taylor coefficients of $G(x, u)$ needed in the proof of Theorem 4.4.10 in the absorption model for $\delta = 0$. First, g_{00} is directly computed from (122). Second, we show that $g_{01} = g_{10}$. The two needed derivatives are

$$\begin{aligned} G_x(x, u) &= S_x(x, u) \left(1 - \frac{P_0^{\geq}(x)}{P(x)} \right) + S(x, u) \frac{\partial}{\partial x} \left(1 - \frac{P_0^{\geq}(x)}{P(x)} \right), \\ G_u(x, u) &= S_u(x, u) \left(1 - \frac{P_0^{\geq}(x)}{P(x)} \right). \end{aligned}$$

As $S(x, u) = S(u, x)$ we see that $S_x(x, u) = S_u(x, u)$. And due to (122) we get $S(1, 1) = 0$ which implies that $g_{10} = g_{01}$. Thus, it suffices to compute $S_u(1, 1)$. Finally, consider the differential quotient

$$\begin{aligned} \frac{S(x, u) - S(1, 1)}{u - 1} &= \frac{S(x, u)}{u - 1} = \frac{\frac{P(x) - P(u)}{(u-1)^2}}{\frac{P(x) - P(u)}{u-1} - \frac{P_0^{\geq}(x) - P_0^{\geq}(u)}{u-1}} \\ &\xrightarrow{x, u \rightarrow 1} \frac{P''(1)}{2(P_0^{\geq})'(1)}, \end{aligned}$$

where we used the fact that

$$\lim_{u \rightarrow 1} \frac{P(u) - 1}{(u - 1)^2} = \frac{P''(1)}{2},$$

which can be seen by a Taylor expansion of $P(u)$ at 1, as $P(1) = 1$ and $P'(1) = 0$.

Remark 18 (Alternative proof of the final altitude of meanders in the absorption model for zero drift). Let us briefly sketch how one can use the half-normal distribution scheme given in Theorem 2.3.9.

Notice that $E(z)$ is singular at ρ due to its dependency on $u_1(z)$. We know that for $\delta = 0$ we have $\tau = 1$, and $\rho = 1$. Combining this with Proposition 1.6.5 it yields the decomposition (30). By elementary computations we get

$$F(z, u)^{-1} = (1 - z) + \sqrt{\frac{P''(1)}{2}}(1 - u)\sqrt{1 - z} \\ + o(1 - z) + o((1 - u)^2),$$

for $z, u \rightarrow 1$. Hence, we have $g_z(\rho, 1) \neq 0$, $h_u(\rho, 1) \neq 0$, and $h(\rho, 1) = g_u(\rho, 1) = g_{uu}(\rho, 1) = 0$ and we can apply Theorem 2.3.9. In accordance with the known result we rederived that

$$\frac{X_n}{\sqrt{n}} \xrightarrow{d} \mathcal{H}(\sigma),$$

with the parameter $\sigma = \sqrt{2} \frac{h_u(\rho, 1)}{\rho g_z(\rho, 1)} = \sqrt{P''(1)}$.

5

LATTICE PATHS BELOW A LINE OF RATIONAL SLOPE

This chapter is based on joint work with Cyril Banderier which has lead to the article *The kernel method for lattice paths below a line of rational slope* which has recently been accepted for publication in the *Developments in Mathematics Series* (Springer), associated with the 8th International Conference on Lattice Path Combinatorics and Applications [28]. A preliminary version of this paper appeared in the Proceedings of the ANALCO15 San Diego Conference, [27].

For the enumeration of simple lattice paths (allowing just the jumps -1 , 0 , and $+1$), many methods are often used, like e.g. the Lagrange inversion, determinant techniques, continued fractions, orthogonal polynomials, bijective proofs, and a lot is known in such cases [83, 129, 145, 148]. These nice methods do not apply to more complex cases of more generic jumps (or, if one adds a spacial boundary, like a line of rational slope). It is then possible to use some ad hoc factorization due to Gessel [95], or context-free grammars to enumerate such lattice paths [73, 134, 142]. One drawback of the grammar approach is that it leads to heavy case-by-case computations (resultants of equations of huge degree). In this chapter, we show how to proceed for the enumeration and the asymptotics in these harder cases: our techniques are relying on the “kernel method” which (contrary to the context-free grammar approach) offers access to the true simple *generic* structure of the final generating functions and the *universality* of their asymptotics via singularity analysis.

Let us start with the history of what Philippe Flajolet named the “kernel method”: It has been part of the folklore of combinatorialists for some time and its simplest application deals with functional equations (with apparently more unknowns than equations!) of the form

$$K(z, u)F(z, u) = p(z, u) + q(z, u)G(z),$$

where the functions p, q , and K are given and where F, G are the unknown generating functions we want to determine. $K(z, u)$ is a polynomial in u which we call the “kernel” as we “test” this functional equation on functions $u(z)$ canceling this kernel¹. The simplest case

¹ The “kernel method” that we mention here for functional equations in combinatorics has nothing to do with what is known as the “kernel method” or “kernel trick” in statistics or machine learning. Also, there is no integral directly related to our kernel. For sure, in our case the word kernel was chosen as its zeros will play a key role, and also, in one sense, as this kernel has in its core the full description of the problem, and its resolution.

is when there is only one branch, $u_1(z)$, such that $K(z, u_1(z)) = 0$ and $u_1(0) = 0$; in that case, a single substitution gives a closed-form solution for G : namely, $G(z) = -p(z, u_1(z))/q(z, u_1(z))$.

Such an approach was introduced in 1969 by Knuth to enumerate permutations sortable by a stack, see the detailed solution to Exercise 2.2.1–4 in *The Art of Computer Programming* ([126, pp. 536–537] and also Exercise 2.2.1.11 therein), which presents a “new method for solving the ballot problem”, for which the kernel K is a quadratic polynomial (this specific case involves just one branch $u_1(z)$).

In combinatorics exist many applications of this method for solving variants of the above functional equation: one is known as the “quadratic method” in map enumeration, as initially developed in 1965 by Brown during his collaboration with Tutte (see Section 2.9.1 from [52], and [20] for the analysis of about a dozen families of maps). During nearly 30 years, the kernel method was dealing only with “quadratic cases” like the ones of Brown for maps or of Knuth for a vast amount of examples involving trees, polyominoes, walks [158], or more exotic applications like e.g. the one mentioned by Odlyzko in his wonderful survey on asymptotic methods in enumeration [57]. Then, in 1998, the initial approach by Knuth was generalized by a group of four people, all of them being in contact and benefiting from mutual insights: Banderier in his memoir [14] solved some problems related to generating trees and walks, this later lead to the article with Flajolet [19] and to the solution of some conjectures due to Pinzani in the article with Bousquet-Mélou et al. [16]. At the same time, Petkovšek analyzed linear multivariate recurrences in [155], a work later extended in [50]. All these articles contributed to turn the original approach by Knuth into a method working when the equation has more unknowns (and the kernel has more roots). This solves equations of the type

$$K(z, u)F(z, u) = \sum_{i=1}^m p_i(z, u)G_i(z),$$

where K and the p_i 's are known polynomials, and where F and the G_i 's are unknown functions.

A few years later, Bousquet-Mélou and Jehanne [46] solved the case of algebraic equations in F of arbitrary degree:

$$P(z, u, F(z, u), G_1(z), \dots, G_m(z)) = 0.$$

The kernel method thus plays a key role in many combinatorial problems. A few examples are directed lattice paths and their asymptotics [19, 44], additive parameters like the area [21, 165], generating trees [16], pattern avoiding permutations [140], prudent walks [12, 71], urn models [164], statistics in posets [45], and many other nice combinatorial structures...

Independently, in probability theory, in the '70s, Malyshev invented an approach now sometimes called the "iterated kernel method". It can be used to analyze nearest neighbor random walks in queuing theory. In this context these lead to the following type of equations:

$$K(t, x, y)F(t, x, y) = p_0(t, x, y) + p_1(t, x, y)F(x, 0) + p_2(t, x, y)F(0, y),$$

where K and the p_i 's are known polynomials, while F is the unknown function we are looking for. This approach culminated in the book [78], which was later revisited in the 2000s (e.g. in [133]), also with a more combinatorial point of view in [49]. It is still the subject of vivid activities, including the extension to higher dimensions [43]. Moreover, the kernel method also gives the transient solution of some birth-death queuing processes [115].

Also independently, in statistical mechanics, several authors developed other incarnations of the kernel method. E.g., the WKB limit of the Bethe Ansatz (also called thermodynamical Bethe Ansatz) often leads to algebraic equations and to what is called the algebraic Bethe Ansatz [94]. The kernel method is also used in the study of the Ising model of bicoloured maps (see Theorem 8.4.5 in [77], and pushing further this method led Eynard to his "topological recurrence"), and in many articles on enumeration related to directed animals, polymers, walks [116, 117, 118].

After this short history of the kernel method, we want to show how to use it to derive explicit counting formulae and asymptotics for directed lattice paths below a line of rational slope. In the article by Banderier & Flajolet [19], the class of directed lattice paths in \mathbb{Z}^2 was investigated thoroughly by means of analytic combinatorics (see [85]). Our work is an extension of this article in mainly five ways:

1. Our work involves lattice paths having a "periodic support". The comment in [19, Section 3.3] was incomplete for this more cumbersome case. Due to several dominant singularities we had to revisit the structural properties of the roots associated to the kernel method in order to understand each of these contributions. This new understanding gives a tool to deal with the asymptotics of many other (lattice path) enumeration problems.
2. We get new explicit formulae for the generating functions of walks with starting and ending at altitude other than 0, and links with complete symmetric homogeneous polynomials.
3. We give new closed forms for the coefficients of these generating functions.
4. We have an application to some harder parameters (like the area below a lattice path).
5. We extend the results to walks below a line of *arbitrary rational* slope.

Plan of this chapter.

- First, in Section 5.1, we recall the fundamental results for lattice paths below a line of slope α (where α is an integer or the inverse of an integer), and the links with trees.
- Then, in Section 5.2, we give Knuth's open problem on lattice paths below a line of slope $2/5$.
- In Section 5.3, we give a bijection between lattice paths below any line of rational slope, and lattice paths from the Banderier–Flajolet model.
- In Section 5.4, the needed bivariate generating function is defined, and the governing functional equation is derived and solved: here the “kernel method” plays the most significant role in order to obtain the generating function (as typical for many combinatorial objects which are recursively defined with a “catalytic parameter”).
- In Section 5.5, we tackle some questions on asymptotics, thus answering the question of Knuth.
- In Section 5.6, we comment on links with previous results of Nakamigawa and Tokushige, which motivated Knuth's problem, and we explain why some cases lead to particularly striking new closed-form formulae.
- In Section 5.7, we analyze what happens for the Duchon's club model (lattice paths below a line of slope $2/3$), and we extend our formulae to general rational slopes.

5.1 TREES, FRACTIONAL TREES, IMAGINARY TREES

Due to their fundamental role in computer science trees were the subject of many investigations, and there exist many alternative representations of this key data structure. One of the most useful ones is an encoding by “traversing” the tree via a depth-first traversal (or via a breadth-first traversal). This directly gives a lattice path associated to the original tree. In fact, what are called “simple families of ordered trees” (rooted ordered trees in which each node has a degree prescribed to be in a given set) are in bijection with lattice paths. The reason is the famous *Lukasiewicz correspondence* between trees and lattice paths, see Figure 11.

Basic manipulations on lattice paths show that *Dyck paths* (paths with jumps North and East, see Figure 24) below the line $y = \alpha x$ (α being here a positive integer), or below the line $y = x/\alpha$, are in bijection with trees (of arity α , i.e., every node has exactly 0 or α children).

The generating function $F(z) = \sum f_n z^n$, where f_n counts the number of trees with n nodes (internal and external ones) satisfies the functional equation $F(z) = z\phi(F(z))$, where ϕ encodes the allowed arities. Thus, we get binary trees: $\phi(F) = 1 + F^2$, unary-binary trees: $\phi(F) = 1 + F + F^2$, t -ary trees: $\phi(F) = 1 + F^t$, general trees: $\phi(F) = 1/(1 - F)$. See [85] for more on this approach, also extendible to unordered trees (i.e., the order of the children is not taken into account).

Because of the bijection with lattice paths, the enumeration of ordered trees solves the question of lattice paths below a line of integer slope. In the simplest case of classical Dyck paths, many tools were developed. In 1886, Delannoy was the first to promote a systematic way to enumerate lattice paths, using recurrences and an array representation (see [25] for more on this). Then, the Bertrand ballot problem [39] (already previously considered by Whitworth) and the ruin problem (as studied along centuries by Fermat, Pascal, the Bernoullis, Huygens, de Moivre, Lagrange, Laplace, Ampère and Rouché) were a strong motor for the birth of the combinatorics of lattice paths, one famous solution being the one by André [9] via a bijective proof involving “good minus bad” paths. Aebly [3] and Mirimanoff [144] gave a geometric variant of this bijective proof, which corresponds to what is nowadays known as the reflection principle. Later, the cycle lemma by Dvoretzky and Motzkin [76] proved useful for many similar problems. During the last century, all these tools were extended and applied to other cases than the classical Dyck paths, and we will use some of them in this chapter.

With respect to the closed form for the enumeration, another powerful tool is the Lagrange–Bürmann inversion formula (see e.g. [85]).

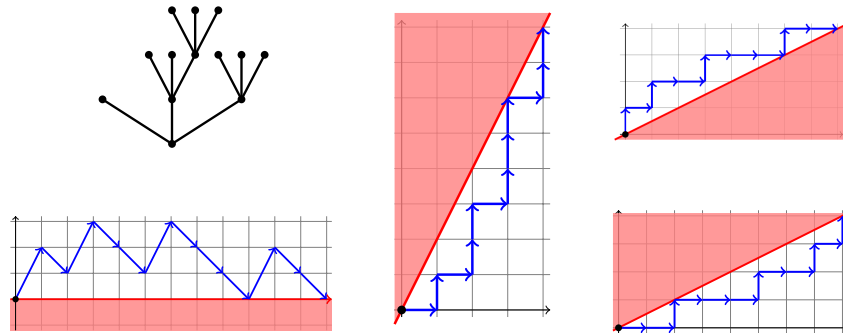

Figure 24: Examples of combinatorial structures which are in bijection: ternary trees, excursions of directed lattice paths with jumps $+2$ and -1 , Dyck paths of North-East steps below the line $y = 2x$, Dyck paths above the line $y = \frac{1}{2}x$, and Dyck paths below the line $y = \frac{1}{2}x$.

Applied on $T(z) = 1 + zT(z)^t$ (the equation for the generating function of t -ary trees where z marks internal nodes), it gives

$$T(z)^r = \sum_{k \geq 0} \binom{tk+r}{k} \frac{r}{tk+r} z^k = \sum_{k \geq 0} \binom{tk+(r-1)}{k} \frac{r}{(t-1)k+r} z^k.$$



Figure 25: It is possible to plug any value for t in $T(z)$, which is known to count trees and lattice paths when t is an integer. What happens when we consider generalized binomial series of order $3/2$, or of other fractional values? To recycle a nice pun by Don Knuth [127]: Nature is offering nice binary trees, will imaginary trees one day play a role in computer science?

Plugging rational values is not directly leading to a power series with integer coefficients, but it “miraculously” becomes the case after basic transformations. For example, as observed by Knuth [127], for $t = 3/2$, one has the following neat non-trivial identity:

$$T(z)T(-z) = \left(\sum_{k \geq 0} \frac{\binom{3k/2}{k}}{k/2+1} z^k \right) \left(\sum_{k \geq 0} \frac{\binom{3k/2}{k}}{k/2+1} (-z)^k \right) = \sum_{n \geq 0} \frac{\binom{3n+1}{n}}{n+1} z^{2n}.$$

What could be the meaning of such identities on “half-trees”? The explanation behind this formula is better seen in terms of lattice paths, and we will shed light on it in the next sections via the kernel method. Another set of mysterious identities is e.g. incarnated by:

$$\ln T(z) = \ln \sum_{n \geq 0} \frac{\binom{tn}{n}}{(t-1)n+1} z^n = \sum_{n \geq 1} \frac{\binom{tn}{n}}{tn} z^n.$$

In fact, this one is just another avatar of the cycle lemma, which is also the reason for the link between the generating function of bridges and the generating function of excursions (a fact also appearing in various disguises e.g. in the Spitzer formula, in the Sparre Andersen formula), see [19] for explanations and proofs.

As we have seen, Dyck paths below an integer slope (or structures in bijection with them) were subject to many approaches, now considered as “folklore”. The first result for lattice paths below a rational slope came much later, and is best summarized by the following theorem:

Theorem 5.1.1 (Bizley’s formula, Grossman’s formula). *The number $f(an, bn)$ of Dyck paths from $(0, 0)$ to (an, bn) staying weakly above $y = \frac{a}{b}x$ is given by the following expressions, where $c_j := \frac{1}{a_j+b_j} \binom{a_j+b_j}{a_j}$:*

$$f(an, bn) = [t^n] \exp \sum_{j \geq 0} \frac{1}{(a+b)} \binom{(a+b)j}{a} t^j, \quad (125)$$

$$f(an, bn) = \sum_{\left\{ \begin{array}{l} \text{integer partitions of } n: \\ \sum_{j=1}^k j e_j = n \end{array} \right\}} \prod_{j=1}^k \frac{(c_j)^{e_j}}{e_j!}. \quad (126)$$

Formula (126) was first stated without proof by Grossman in 1950. A proof was then given by Bizley [41] in 1954. It starts with Formula (125), which is an avatar of the cycle lemma [76] expressed in terms of a generating function. Then routine power series manipulation gives Formula (126). These formulae (or special cases of them) have since been rediscovered (and published...) many times. One nice modern formulation of the method behind is found in the article by Gessel [95]. There exist alternative generic formulae as given by Banderier and Flajolet [19], Sato [162], which simplify for ad hoc cases [22, 73].

This formula admits many extensions as one could for example add parameters or take into account certain patterns. This would lead to “rational” Narayana numbers, “rational” q-analogs, “rational” Mahonian statistics (on lattice paths!), etc.

For each n , Grossman’s formula (126) for $f(an, bn)$ involves $p(n)$ summands, where $p(n)$ is the integer partition sequence of Hardy–Ramanujan fame:

$$p(n) = [t^n] \prod_{n \geq 1} \frac{1}{1-t^n} \sim \frac{1}{4n\sqrt{3}} \exp \left(\pi \sqrt{\frac{2n}{3}} \right).$$

Therefore, this nice closed-form formula of Grossman has many summands if n is large (computing it will have an exponential cost); it is thus useful to have an algorithmic alternative to it. Bizley’s formula (125) allows to compute $f(an, bn)$ in quasi-linear time by a power series manipulation. This is also the advantage of other expressions like the ones given by [19] using the kernel method, on which we will come back in the next sections.

Formula (125) for $n = 1$ gives $f(a, b) = \frac{1}{a+b} \binom{a+b}{a}$, also known as the rational Catalan numbers $\text{Cat}(a, b)$. In the last years many properties of the Dyck paths and their “Catalan combinatorics” (i.e., the enumeration of the numerous combinatorial and algebraic structures related to them) were extended to Dyck paths below a line of rational slope. This new area of research is sometimes called “rational Catalan combinatorics” [10]. We expect that the recent developments of “rational Catalan combinatorics” have a generalization to $n > 1$, but with less simple formulae, as suggested by Table 18.

	# Dyck walks from $(0,0)$ to (an, bn) staying weakly below $y = \frac{a}{b}x$
$n = 1$	c_1
$n = 2$	$c_2 + \frac{c_1^2}{2}$
$n = 3$	$c_3 + c_1c_2 + \frac{c_1^3}{3!}$
$n = 4$	$c_4 + \frac{c_2^2}{2} + c_1c_3 + \frac{c_1^2c_2}{2} + \frac{c_1^4}{4!}$
$n = 5$	$c_5 + c_2c_3 + c_1c_4 + \frac{c_1c_2^2}{2} + \frac{c_1^2c_3}{2} + \frac{c_1^3c_2}{3!} + \frac{c_1^5}{5!}$
$n = 6$	$c_6 + c_5c_1 + c_4c_2 + \frac{c_1^2c_4}{2} + \frac{c_2^2}{2} + \frac{c_3^2}{3!} + \frac{c_2c_1^4}{4!} + \frac{c_1^3c_3}{3!} + \frac{c_1^2c_2^2}{4} + c_1c_2c_3 + \frac{c_1^6}{6!}$
\vdots	\vdots
n	$\sum_{\left\{ \begin{array}{l} \text{integer partitions of } n: \\ \sum_{j=1}^k j e_j = n \end{array} \right\}} \prod_{j=1}^k \frac{(c_j)^{e_j}}{e_j!}$

Table 18: The number $f(an, bn)$ of Dyck walks from $(0,0)$ to (an, bn) staying weakly below $y = \frac{a}{b}x$. To shorten our expressions, we use the shorthand $c_j := \frac{1}{aj+bj} \binom{aj+bj}{aj}$.

In the rest of the chapter, we will see further nice formulae for Dyck paths below a rational slope.

5.2 KNUTH’S AOFA PROBLEM #4

During the conference “Analysis of Algorithms” (AofA 2014) in Paris in June 2014, Knuth gave the first invited talk, dedicated to the memory of Philippe Flajolet (1948-2011). The title of his lecture was “Problems that Philippe would have loved” and he was pinpointing/developing five nice open problems with a good flavor of “analytic combinatorics” (his slides are available online²). The fourth problem was on “Lattice paths of slope $2/5$ ”, in which Knuth investigated Dyck paths under a line of slope $2/5$, following the work of [147]. This is best summarized by the two following original slides of Knuth:

$A[i, j] = \begin{cases} 0, & \text{if } j \geq 2i/5 + 2/5, \\ A[i-1, j] + A[i, j-1], & \text{if } j < 2i/5 + 2/5; \end{cases}$ $B[i, j] = \begin{cases} 0, & \text{if } j \geq 2i/5 + 1/5, \\ B[i-1, j] + B[i, j-1], & \text{if } j < 2i/5 + 1/5; \end{cases}$ <p>$A[i, 0] = B[i, 0] = 1$. When $0 \leq i \leq 4$ and $0 \leq j \leq 10$ we have:</p> $A = \begin{pmatrix} 1 & 1 & 1 & 1 & 1 & 1 & 1 & 1 & 1 & 1 \\ 0 & 0 & 1 & 2 & 3 & 4 & 5 & 6 & 7 & 8 & 9 \\ 0 & 0 & 0 & 0 & 0 & 4 & 9 & 15 & 22 & 30 & 39 \\ 0 & 0 & 0 & 0 & 0 & 0 & 0 & 15 & 37 & 67 & 106 \\ 0 & 0 & 0 & 0 & 0 & 0 & 0 & 0 & 0 & 0 & 106 \end{pmatrix}$ $B = \begin{pmatrix} 1 & 1 & 1 & 1 & 1 & 1 & 1 & 1 & 1 & 1 \\ 0 & 0 & 0 & 1 & 2 & 3 & 4 & 5 & 6 & 7 & 8 \\ 0 & 0 & 0 & 0 & 0 & 3 & 7 & 12 & 18 & 25 & 33 \\ 0 & 0 & 0 & 0 & 0 & 0 & 0 & 0 & 18 & 43 & 76 \\ 0 & 0 & 0 & 0 & 0 & 0 & 0 & 0 & 0 & 0 & 76 \end{pmatrix}$	<p>Thus $A[x, y]$ enumerates lattice paths from $(0,0)$ that stay in the region $y < \frac{2}{5}x + \frac{2}{5}$, while $B[x, y]$ enumerates the paths that stay in the region $y < \frac{2}{5}x + \frac{1}{5}$.</p> <p>Theorem (Nakamigawa, Tokushige, 2012):</p> $A[5t-1, 2t-1] + B[5t-1, 2t-1] = \frac{2}{7t-1} \binom{7t-1}{2t}, \quad \text{for all } t \geq 1.$ <p>Empirical observation:</p> $\frac{A[5t-1, 2t-1]}{B[5t-1, 2t-1]} = a - \frac{b}{t} + O(t^{-2}),$ <p>where $a \approx 1.63026$ and $b \approx 0.159$ (I think).</p>
--	---

² <http://www-cs-faculty.stanford.edu/~uno/flaj2014.pdf>

In the next sections we prove that Knuth was indeed right! In order not to conflict with our notation, let us rename Knuth's constants a and b into κ_1 and κ_2 .

5.3 A BIJECTION FOR LATTICE PATHS BELOW A RATIONAL SLOPE

Consider paths in the \mathbb{N}^2 lattice³, starting in the origin, and whose allowed steps are of the type either East or North (i.e., steps $(1, 0)$ and $(0, 1)$, respectively). Let α, β be positive rational numbers. We restrict the walks to stay strictly below the barrier $L : y = \alpha x + \beta$. Hence, the allowed domain of our walks forms an obtuse cone with the x -axis, the y -axis and the barrier L as boundaries. The problem of counting walks in such a domain is equivalent to counting directed walks in the Banderier–Flajolet model [19], as seen via the following bijection:

Proposition 5.3.1 (Bijection: Lattice paths below a rational slope are directed lattice paths). *Let $\mathcal{D} : y < \alpha x + \beta$ be the domain strictly below the barrier L . From now on, we assume without loss of generality that $\alpha = a/c$ and $\beta = b/c$ where a, b, c are positive integers such that $\gcd(a, b, c) = 1$ (thus, it may be the case that a/c or b/c are reducible fractions). There exists a bijection between “walks starting from the origin with North and East steps” and “directed walks starting from $(0, b)$ with the step set $\{(1, a), (1, -c)\}$ ”. What is more, the restriction of staying below the barrier L is mapped to the restriction of staying above the x -axis.*

Proof. The following affine transformation gives the bijection (see Figure 26):

$$\begin{pmatrix} x \\ y \end{pmatrix} \mapsto \begin{pmatrix} x + y \\ ax - cy + b \end{pmatrix}.$$

Indeed, the determinant of the involved linear mapping is $-(c + a) \neq 0$. What is more, the constraint of being below the barrier (i.e., one has $y < \alpha x + \beta$) is thus forcing the new abscissa to be positive: $ax - cy + b > 0$. The gcd conditions ensure an optimal choice (i.e., the thinnest lattice) for the lattice on which walks will live. Note that this affine transformation gives a bijection not only in the case of an initial step set North and East, but for any set of jumps. \square

The purpose of this bijection is to map walks of length n to meanders (i.e., walks that stay above the x -axis) which are constructed by n unit steps into the positive x direction.

Note that if one does not want the walk to touch the line $y = (a/c)x + b/c$, it corresponds to a model in which one allows to touch, but with a border at $y = (a/c)x + (b - 1)/c$. Time reversal is also giving a bijection between

³ We live in a world where $0 \in \mathbb{N}$.

We apply the *kernel method* in order to transform this equation into a system of linear equations for F_0 and F_1 . The factor $K(z, u) := 1 - zP(u)$ is called the *kernel* and the kernel equation is given by $K(z, u) = 0$. Solving this equation for u , we obtain 7 distinct solutions. These split into two groups, namely, we get 2 small roots $u_1(z)$ and $u_2(z)$ (the ones going to 0 for $z \sim 0$) and 5 large roots which we call $v_i(z)$ for $i = 1, \dots, 5$ (the ones going to infinity for $z \sim 0$). It is legitimate to insert the 2 small branches into (127) to obtain⁴

$$\begin{aligned} zF_0 + zu_1F_1 &= u_1^2f_0(u_1), \\ zF_0 + zu_2F_1 &= u_2^2f_0(u_2). \end{aligned}$$

This linear system is easily solved by Cramer's rule, which yields

$$\begin{aligned} F_0(z) &= -\frac{u_1u_2(u_1f_0(u_1) - u_2f_0(u_2))}{z(u_1 - u_2)}, \\ F_1(z) &= \frac{u_1^2f_0(u_1) - u_2^2f_0(u_2)}{z(u_1 - u_2)}. \end{aligned}$$

Now, let the functions $F(z, u)$ and $F_k(z)$ denote functions associated with $f_0(u) = u^3$ (i.e., there is one walk of length 0 at altitude 3) and let the functions $G(z, u)$ and $G_k(z)$ denote functions associated with $f_0(u) = u^4$. One thus gets the following theorem:

Theorem 5.4.1 (Closed-forms for the generating functions). *Let us consider walks in \mathbb{N}^2 with jumps -2 and $+5$. The number of such walks starting at altitude 3 and ending at altitude 0 is given by $F_0(z)$, the number of such walks starting at altitude 4 and ending at altitude 1 is given by $G_1(z)$, and we have the following closed-forms in terms of the small roots $u_1(z)$ and $u_2(z)$ of $1 - zP(u) = 0$ with $P(u) = u^{-2} + u^5$:*

$$F_0(z) = -\frac{u_1u_2(u_1^4 - u_2^4)}{z(u_1 - u_2)}, \quad G_1(z) = \frac{u_1^6 - u_2^6}{z(u_1 - u_2)}.$$

Thanks to the bijection given in Section 5.3 between walks in the rational slope model and directed lattice paths in the Banderier–Flajolet model (and by additionally reversing the time⁵), it is now possible to relate the quantities A and B of Knuth with F_0 and G_1 :

$$\begin{aligned} A_n &:= A[5n - 1, 2n - 1] = [z^{7n-2}]G_1(z), \\ B_n &:= B[5n - 1, 2n - 1] = [z^{7n-2}]F_0(z). \end{aligned} \tag{128}$$

Indeed, from the bijection of Proposition 5.3.1, the walks strictly below $y = \frac{a}{c}x + \frac{b}{c}$ (with $a = 2$, $c = 5$) and ending at $(x, y) = (5n -$

⁴ In this chapter, whenever we thought it could ease the reading, without harming the understanding, we write u_1 for $u_1(z)$, or F for $F(z)$, etc.

⁵ Reversing the time allows us to express all generating functions in terms of just 2 roots. If one does not reverse time, everything works well but the expressions contain the 5 large roots, yielding more complicated closed-forms.

$1, 2n - 1$) are mapped (in the Banderier–Flajolet model, not allowing to touch $y = 0$) to walks starting at $(0, b)$ and ending at $(x + y, ax - cy + b) = (7n - 2, 3 + b)$. Reversing the time and allowing to touch $y = 0$ (thus b becomes $b - 1$), gives that A_n counts walks starting at 4, ending at 1 (yeah, this is counted by G_1 !) and that B_n counts walks starting at 3, ending at 0 (yeah, this is counted by F_0 !). While there is no nice formula for A_n or B_n (see, however, [17] and page 180 for a formula involving nested sums of binomials), it is striking that there is a simple and nice formula for $A_n + B_n$:

Theorem 5.4.2 (Closed-form for the sum of coefficients). *The sum of the number of Dyck paths (in our rational slope model) touching or staying below $y = (2/5)x + 1/5$ and $y = (2/5)x$ simplifies to the following expression:*

$$A_n + B_n = \frac{2}{7n - 1} \binom{7n - 1}{2n}. \quad (129)$$

Proof. A first proof of this was given by [147] using a variant of the cycle lemma. (We comment more on this in Section 5.6.) We give here another proof. Indeed, our Theorem 5.4.1 (Closed-form for the generating functions) implies that

$$A_n + B_n = [z^{7n-1}] (u_1^5 + u_2^5). \quad (130)$$

This suggests using holonomy theory to prove the theorem. First, a resultant equation gives the algebraic equation for $U := u_1^5$ (namely, $z^7 + (U - 1)^5 U^2 = 0$) and then the Abel–Tannery–Cockle–Harley–Comtet theorem (see the comment after Proposition 4 in [17]) transforms it into a differential equation for the series $u_1^5(z^2)$. It is also the differential equation (up to distinct initial conditions) for $u_2^5(z^2)$ (as u_2 is defined by the same equation as u_1), and thus of $u_1^5(z^2) + u_2^5(z^2)$. Therefore, it directly gives the differential equation for the series $C(z) = \sum_n (A_n + B_n) z^n$, and it corresponds to the following recurrence for its coefficients:

$$C_{n+1} = \frac{7(7n+5)(7n+4)(7n+3)(7n+2)(7n+1)(7n-1)}{10(5n+4)(5n+3)(5n+2)(5n+1)(2n+1)(n+1)} C_n,$$

which is exactly the hypergeometric recurrence for $\frac{2}{7n-1} \binom{7n-1}{2n}$ (with the same initial condition). This computation takes 1 second on an average computer, while, if not done in this way (e.g., if instead of the resultant shortcut above, one uses several `gfun[diffeq*diffeq]` or variants of it in Maple, see [161] for a presentation of the corresponding package), the computations for such a simple binomial formula surprisingly take hours. \square

Some additional investigations conducted by Manuel Kauers (private communication) show that this is the only linear combination of A_n and B_n which leads to a hypergeometric solution (to prove

this, you can compute a recurrence for a formal linear combination $rA_n + sB_n$, and then check which conditions it implies on r and s if one wishes the associated recurrence to be of order 1, i.e., hypergeometric). It thus appears that $rA_n + sB_n$ is generically of order 5, with the exception of a sporadic $4A_n - B_n$ which is of order 4, and the miraculous $A_n + B_n$ which is of order 1 (hypergeometric).

However, there are many other hypergeometric expressions floating around: expressions of the type of the right-hand side of (130) have nice hypergeometric closed-forms. This can also be explained in a combinatorial way. Indeed, we observe that setting $k = -5$ in Formula (10) from [19], leads to $5W_{-5}(z) = \Theta(A(z) + B(z))$ (where Θ is the pointing operator). The “Knuth pointed walks” are thus in 1-to-5 correspondence with unconstrained walks (see our Table 2, top left) ending at altitude -5.

We want to end this section with exemplifying the miracles involved in the simplifications of (129). Using the Flajolet–Soria formula [17] for the coefficients of an algebraic function, we can extract the coefficient of z^{7n-2} of $G_1(z)$ and $F_0(z)$ in terms of nested sums. According to (128), this corresponds to A_n and B_n , which are thus given by formulae involving respectively 45 and 34 nested sums (see Figure 27).

Then, in the next section, we perform some analytic investigations in order to prove what Knuth conjectured:

$$\frac{A_n}{B_n} = \kappa_1 - \frac{\kappa_2}{n} + \mathcal{O}(n^{-2}),$$

with $\kappa_1 \approx 1.63026$ and $\kappa_2 \approx 0.159$.

5.5 ASYMPTOTICS

As usual, we need to locate the dominant singularities, and to understand the local behavior there. The fact that there are several dominant singularities makes the game harder here, and this case was only sketched in [19]. Similarly to what happens in the rational world (Perron–Frobenius theory), or in the algebraic world (see [17]), a periodic behavior of the generating function leads to some more complicated proofs, because additional details have to be taken into account. With respect to walks, it is e.g. crucial to understand how singularities spread amongst the roots of the kernel. To this aim, some quantities will play a key role: the structural constant τ is defined as the unique positive root of $P'(\tau)$, where

$$P(u) = u^{-2} + u^5$$

⁶ Via the kernel method, as explained in [22], it is possible to express A_n and B_n with less nested sums than in Figure 27 but the corresponding formulae are however still of the “ugly” type!

$$\begin{aligned}
 A_n = \sum_{m=0}^{7n-2} m! \sum_{\substack{m_1+\dots+m_{44}=m+1 \\ b_1 m_1+\dots+b_{44} m_{44}=7n-2 \\ c_1 m_2+\dots+c_{44} m_{44}=m}} & \left(20^{m_1} 3^{m_2} (-190)^{m_3} (-39)^{m_4} 1140^{m_5} 239^{m_6} \right. \\
 & 4^{m_7} (-4845)^{m_8} (-915)^{m_9} (-25)^{m_{10}} 15504^{m_{11}} 2443^{m_{12}} 68^{m_{13}} 1^{m_{14}} \\
 & (-38760)^{m_{15}} (-4806)^{m_{16}} (-105)^{m_{17}} 77520^{m_{18}} 7173^{m_{19}} 100^{m_{20}} \\
 & (-125970)^{m_{21}} (-8238)^{m_{22}} (-59)^{m_{23}} 167960^{m_{24}} 7305^{m_{25}} 20^{m_{26}} \\
 & (-184756)^{m_{27}} (-4971)^{m_{28}} (-3)^{m_{29}} 167960^{m_{30}} 2553^{m_{31}} (-125970)^{m_{32}} \\
 & (-959)^{m_{33}} 77520^{m_{34}} 249^{m_{35}} (-38760)^{m_{36}} (-40)^{m_{37}} 15504^{m_{38}} 3^{m_{39}} \\
 & \left. (-4845)^{m_{40}} 1140^{m_{41}} (-190)^{m_{42}} 20^{m_{43}} (-1)^{m_{44}} \prod_{k=1}^{44} \frac{1}{m_k!} \right),
 \end{aligned}$$

where $(b_n)_{n=1}^{44} = (2,5,4,7,6,9,12,8,11,14,10,13,16,19,12,15,18,14,17,20,16,19,22,18,21,24,20,23,26,22,25,24,27,26,29,28,31,30,33,32,34,36,38,40)$ and $(c_n)_{n=1}^{44} = (2,0,3,1,4,2,0,5,3,1,6,4,2,0,7,5,3,8,6,4,9,7,5,10,8,6,11,9,7,12,10,13,11,14,12,15,13,16,14,17,18,19,20,21)$.

$$\begin{aligned}
 B_n = \sum_{m=0}^{7n-2} m! \sum_{\substack{m_1+\dots+m_{33}=m+1 \\ b_1 m_1+\dots+b_{33} m_{33}=7n-2 \\ c_1 m_2+\dots+c_{33} m_{33}=m}} & \left(20^{m_1} 2^{m_2} (-182)^{m_3} (-18)^{m_4} 1006^{m_5} 73^{m_6} \right. \\
 & (-1)^{m_7} (-3793)^{m_8} (-176)^{m_9} 10349^{m_{10}} 279^{m_{11}} (-21084)^{m_{12}} (-294)^{m_{13}} \\
 & 32521^{m_{14}} 190^{m_{15}} 1^{m_{16}} (-37980)^{m_{17}} (-57)^{m_{18}} (-10)^{m_{19}} 33128^{m_{20}} 45^{m_{21}} \\
 & (-20928)^{m_{22}} (-120)^{m_{23}} 9039^{m_{24}} 210^{m_{25}} (-2384)^{m_{26}} (-252)^{m_{27}} \\
 & \left. 289^{m_{28}} 210^{m_{29}} (-120)^{m_{30}} 45^{m_{31}} (-10)^{m_{32}} 1^{m_{33}} \prod_{k=1}^{33} \frac{1}{m_k!} \right),
 \end{aligned}$$

where $(b_n)_{n=1}^{33} = (2,5,4,7,6,9,12,8,11,10,13,12,15,14,17,13,16,19,15,18,17,20,19,22,21,24,23,26,25,27,29,31,33)$ and $(c_n)_{n=1}^{33} = (2,0,3,1,4,2,0,5,3,6,4,7,5,8,6,11,9,7,12,10,13,11,14,12,15,13,16,14,17,18,19,20,21)$.

$$A_n + B_n = \frac{2}{7n-1} \binom{7n-1}{2n}.$$

Figure 27: **The “ugly + ugly = nice” formula.** A_n is counting Dyck paths touching or staying below the line $y = (2/5)x + 1/5$, and B_n is counting Dyck paths touching or staying below the line $y = (2/5)x$. They are given by complicated “ugly” nested sums⁶, so the miracle is that the sum $A_n + B_n$ is nice. We give several explanations of this fact in this chapter.

is encoding the jumps, and the structural radius ρ is given as $\rho = 1/P(\tau)$. For our problem, one thus has the explicit values:

$$\tau = \sqrt[7]{\frac{2}{5}}, \quad P(\tau) = \frac{7}{10} \sqrt[7]{2^5 5^2}, \quad \rho = \frac{\sqrt[7]{2^2 5^5}}{7}.$$

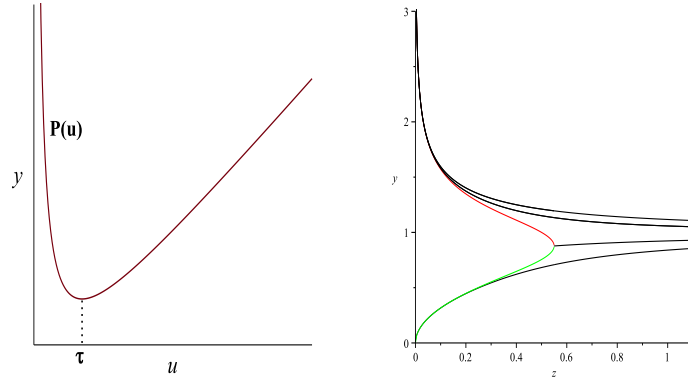

Figure 28: $P(u)$ is the polynomial encoding the jumps, its saddle point τ gives the singularity $\rho = 1/P(\tau)$ where the small root u_1 (in green) meets the large root v_1 (in red), with a square root behavior. (In black, we also plotted $|u_2|, |v_2| = |v_3|$, and $|v_4| = |v_5|$.) This is the key for all asymptotics of such lattice paths.

From [19], we know that the small branches $u_1(z)$ and $u_2(z)$ are possibly singular only at the roots of $P'(u)$. Note that the jump polynomial is *periodic* with period $p = 7$ as $P(u) = u^{-2}H(u^7)$ with $H(u) = 1 + u$. Due to that, there are 7 possible singularities of the small branches

$$\zeta_k = \rho \omega^k, \quad \text{with } \omega = e^{2\pi i/7}.$$

Let us quickly recall Definition 1.6.1: We call a function $F(z)$ *p-periodic* if there exists a function $H(z)$ such that $F(z) = H(z^p)$.

Additionally, we have the following local behaviors:

Lemma 5.5.1 (Local behavior due to rotation law). *The limits of the small branches when $z \rightarrow \zeta_k$ exist and are equal to*

$$u_1(z) \underset{z \sim \zeta_k}{=} \begin{cases} \tau \omega^{-3k} + C_k \sqrt{1 - z/\zeta_k} + \mathcal{O}((1 - z/\zeta_k)^{3/2}), & k = 2, 5, 7, \\ \tau_2 \omega^{-3k} + D_k(1 - z/\zeta_k) + \mathcal{O}((1 - z/\zeta_k)^2), & k = 1, 3, 4, 6, \end{cases}$$

$$u_2(z) \underset{z \sim \zeta_k}{=} \begin{cases} \tau_2 \omega^{-3k} + D_k(1 - z/\zeta_k) + \mathcal{O}((1 - z/\zeta_k)^2), & k = 2, 5, 7, \\ \tau \omega^{-3k} + C_k \sqrt{1 - z/\zeta_k} + \mathcal{O}((1 - z/\zeta_k)^{3/2}), & k = 1, 3, 4, 6, \end{cases}$$

where $\tau_2 = u_2(\rho) \approx -0.707723271$ is the unique real root of $500t^{35} + 3900t^{28} + 13540t^{21} + 27708t^{14} + 37500t^7 + 3125$, $C_k = -\frac{\tau}{\sqrt{5}} \omega^{-3k}$, and

$$D_k = \tau_2 \frac{\tau_2^7 + 1}{5\tau_2^7 - 2} \omega^{-3k}.$$

Proof. We will show the following *rotation law* for the small branches (for all $z \in \mathbb{C}$, with $|z| \leq \rho$ and $0 < \arg(z) < \pi - 2\pi/7$):

$$\begin{aligned} u_1(\omega z) &= \omega^{-3}u_2(z), \\ u_2(\omega z) &= \omega^{-3}u_1(z). \end{aligned}$$

Indeed, let us consider the function $U(z) := \omega^3 u_i(\omega z)$ (with $i = 1$ or $i = 2$, as you prefer!) and the quantity X , defined by $X(z) := U^2 - z\phi(U)$ (where $\phi(u) := u^2P(u)$). So we have $X(z) = (\omega^3 u_i(\omega z))^2 - z\phi(\omega^3 u_i(\omega z)) = \omega^6 u_i(\omega z)^2 - z\phi(u_i(\omega z))$ (because ϕ is 7-periodic), and therefore $\omega X(z/\omega) = \omega(\omega^6 u_i(z)^2 - z/\omega\phi(u_i(z))) = u_i(z)^2 - z\phi(u_i(z))$, which is 0 because we recognize here the kernel equation. This implies that $X = U^2 - z\phi(U) = 0$ and thus U is a root of the kernel. Which one? It is one of the small roots, because it is converging to 0 at 0. What is more, this root U is not u_i , because it has a different Puiseux expansion (and Puiseux expansions are unique). So, by the analytic continuation principle (therefore, here, as far as we avoid the cut line $\arg(z) = -\pi$), we just proved that $\omega^3 u_1(\omega z) = u_2(z)$ and $\omega^3 u_2(\omega z) = u_1(z)$ (and this also proves a similar rotation law for large branches, but we do not need it).

Accordingly, at every ζ_k , amongst the two small branches, only one branch becomes singular: this is u_1 for $k = 2, 5, 7$ and u_2 for $k = 1, 3, 4, 6$. This is illustrated in Figure 29.

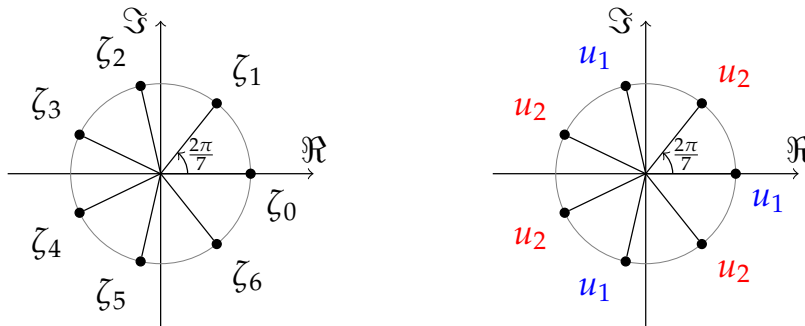

Figure 29: The locations of the 7 possible singularities of the small branches (left); the small branch which is singular at that location (right).

Hence, we directly see how the asymptotic expansion at the dominant singularities are correlated with the one of u_1 at $z = \rho = \zeta_7$, which we derive following the approach of [19]; this gives for $z \sim \rho$:

$$u_1(z) = \tau + C_7\sqrt{1 - z/\rho} + C'_7(1 - z/\rho)^{3/2} + \dots,$$

where $C_7 = -\sqrt{2\frac{P(\tau)}{P'(\tau)}}$. Note that in our case $P^{(3)}(\tau) = 0$ (this funny cancellation holds for any $P(u) = p_5u^5 + p_0 + p_{-2}u^{-2}$), so even the formula for C'_7 is quite simple: $C'_7 = -\frac{1}{2}C_7$.

In the lemma, the formula for $\tau_2 = u_2(\rho)$ is obtained by a resultant computation. \square

For the local analysis of Knuth's generating functions $F_0(z)$ and $G_1(z)$ with periodic support, we introduce a shorthand notation:

Definition 5.5.2 (Local asymptotics extractor $[z^n]_{\zeta_k}$). *Let $F(z)$ be an algebraic function with p dominant singularities ζ_k (for $k = 1, \dots, p$). Accordingly, for each ζ_k , $F(z)$ can be expressed as a Puiseux series, i.e., there exist $r \in \mathbb{Q}$ and coefficients c_n (both depending on k) such that*

$$F(z) = \sum_{j \geq 0} c_j (1 - z/\zeta_k)^{rj}, \quad \text{for } z \sim \zeta_k.$$

Then we define the local asymptotic extractor $[z^n]_{\zeta_k}$ as

$$[z^n]_{\zeta_k} F(z) := \sum_{j \geq 0} c_j [z^n] (1 - z/\zeta_k)^{rj}.$$

This notation can be considered as "extracting the coefficient of z^n in the Puiseux expansion⁷ of $F(z)$ at $z = \zeta_k$ ". Then singularity analysis allows to write $[z^n]F(z) \sim \sum_k [z^n]_{\zeta_k} F(z)$.

Example 5.5.3. A sloppy but easy to remember formulation would be to say

$$[z^n]_{\zeta_k} F(z) := [z^n](\text{singular expansion of } F(z) \text{ at } z = \zeta_k).$$

This is well illustrated by the generating function $D(z)$ of Dyck paths defined by the functional equation $D(z) = 1 + z^2 D(z)^2$. In this case, we have $D(z) = \frac{1 - \sqrt{1 - 4z^2}}{2z^2}$ with $p = 2$ and $\zeta_1 = 1/2$ and $\zeta_2 = -1/2$. Therefore we get for any $\varepsilon > 0$

$$\begin{aligned} [z^n]D(z) &= [z^n]_{1/2} D(z) + [z^n]_{-1/2} D(z) + o((2 - \varepsilon)^n) \\ &= [z^n](-2\sqrt{2})\sqrt{1 - 2z} + [z^n](-2\sqrt{2})\sqrt{1 + 2z} \\ &\quad + O\left(\frac{2^n}{n^{5/2}}\right) + o((2 - \varepsilon)^n). \end{aligned}$$

Proposition 5.5.4 (Periodic rule of thumb). *Let ρ be the positive real dominant singularity in the previous definition. If additionally the generating function $F(z)$ satisfies a rotation law $F(\omega z) = \omega^m F(z)$ (where $\omega = \exp(2i\pi/p)$, p maximal), then one has a neat simplification:*

$$[z^n]F(z) = p[z^n]_{\rho} F(z) + o(\rho^n),$$

if $n - m$ is a multiple of p . (The other coefficients are equal to 0.)

⁷ In fact this notation holds for singular expansions of alg-log functions [85], exp-log functions, and more generally for expansions in Hardy fields [103] which are amenable to singularity analysis or saddle point methods.

Proof. As $F(z)$ is a generating function, it has real positive coefficients and therefore, by Pringsheim’s theorem [85, Theorem IV.6], one of the ζ_k ’s has to be real positive, called ρ . We relabel the ζ_k ’s such that $\zeta_k := \omega^k \rho$. Then

$$\begin{aligned} [z^n]F(z) - o(\rho^n) &= \sum_{k=1}^p [z^n]_{\zeta_k} F(z) = \sum_{k=1}^p [z^n]_{\zeta_k} (\omega^m)^k F(\omega^{-k}z) \\ &= \sum_{k=1}^p (\omega^m)^k (\omega^{-k})^n [z^n]_{\rho} F(z) \\ &= \left(\sum_{k=1}^p (\omega^k)^{m-n} \right) [z^n]_{\rho} F(z) = p [z^n]_{\rho} F(z), \end{aligned}$$

if $n - m$ is a multiple of p , and 0 elsewhere. □

We can apply this proposition to $F_0(z)$ and $G_1(z)$, because the rotation law for the u_i ’s implies: $F_0(\omega z) = \omega^{-2}F_0(z)$ and $G_1(\omega z) = \omega^{-2}G_1(z)$. Thus, we just have to compute the asymptotics coming from the Puiseux expansion of $F_0(z)$ and $G_1(z)$ at $z = \rho$, and multiply it by 7 (recall that it is classical to infer the asymptotics of the coefficients from the Puiseux expansion of the functions via the so-called “transfer” Theorem VI.3 from [85]), this gives:

Theorem 5.5.5 (Asymptotics of coefficients, answer to Knuth’s problem). *The asymptotics for the number of excursions below $y = (2/5)x + 2/5$ and $y = (2/5)x + 1/5$ are given by:*

$$\begin{aligned} A_n &= [z^{7n-2}]G_1(z) = \alpha_1 \frac{\rho^{-7n}}{\sqrt{\pi(7n-2)^3}} + \frac{3\alpha_2}{2} \frac{\rho^{-7n}}{\sqrt{\pi(7n-2)^5}} + \mathcal{O}(n^{-7/2}), \\ B_n &= [z^{7n-2}]F_0(z) = \beta_1 \frac{\rho^{-7n}}{\sqrt{\pi(7n-2)^3}} + \frac{3\beta_2}{2} \frac{\rho^{-7n}}{\sqrt{\pi(7n-2)^5}} + \mathcal{O}(n^{-7/2}), \end{aligned}$$

with the following constants where we define the shorthand $\mu := \tau_2 / \tau$:

$$\begin{aligned} \alpha_1 &= \frac{\mu^4 + 2\mu^3 + 3\mu^2 + 4\mu + 5}{\sqrt{5}}, \quad \beta_1 = \sqrt{5} - \alpha_1, \quad \beta_2 = -\frac{9}{10}\sqrt{5} - \alpha_2, \\ \alpha_2 &= \frac{\tau_2^7(13\mu^4 + 22\mu^3 + 29\mu^2 + 36\mu + 45)}{2\sqrt{5}(2 - 5\tau_2^7)} \\ &\quad + \frac{15\mu^4 + 20\mu^3 + 13\mu^2 - 8\mu - 45}{5\sqrt{5}(2 - 5\tau_2^7)}. \end{aligned}$$

This theorem leads to the following asymptotics for $A_n + B_n$ (and this is for sure a good sanity test, coherent with a direct application of Stirling’s formula to the closed-form formula (129) for $A_n + B_n$):

$$A_n + B_n = \sqrt{\frac{5}{7^3\pi}} \frac{\rho^{-7n}}{\sqrt{n^3}} + \mathcal{O}(n^{-5/2}).$$

Finally, we directly get

$$\frac{A_n}{B_n} = \frac{\alpha_1 + \frac{3\alpha_2}{2(7n-2)}}{\beta_1 + \frac{3\beta_2}{2(7n-2)}} + \mathcal{O}(n^{-2}) = \frac{\alpha_1}{\beta_1} + \frac{3}{14} \left(\frac{\alpha_2\beta_1 - \alpha_1\beta_2}{\beta_1^2} \right) \frac{1}{n} + \mathcal{O}(n^{-2}),$$

which implies that Knuth's constants are

$$\begin{aligned} \kappa_1 &= \frac{\alpha_1}{\beta_1} = -\frac{5}{\mu^4 + 2\mu^3 + 3\mu^2 + 4\mu} - 1 \\ &\approx 1.6302576629903501404248, \\ \kappa_2 &= -\frac{3}{14} \left(\frac{\alpha_2\beta_1 - \alpha_1\beta_2}{\beta_1^2} \right) \\ &= \frac{3}{9800} (13 - 236\kappa_1 - 194\kappa_1^2 - 388\kappa_1^3 + 437\kappa_1^4) \\ &\approx 0.1586682269720227755147. \end{aligned}$$

Now a few resultant computations give the algebraic equations satisfied by τ_2 , κ_1 , and κ_2 . We will illustrate their derivation with the required Maple commands. In what follows, these are always set in a typewriter font. First, we compute an annihilating polynomial for ρ :

```
> R1:=resultant( numer(1-z*P), numer(diff(P,u)), u);
      R1 := 823543 z^7 - 12500
```

Then, we construct from it an annihilating polynomial for $u_i(\rho)$.

```
> R2:=factor(resultant( numer(1-z*P), R1, z));
(500 u^35 + 3900 u^28 + 13540 u^21 + 27708 u^14 + 37500 u^7 + 3125) (2 - 5 u^7)^2
```

This polynomial contains $u_1(\rho) = \tau$, and $u_2(\rho) = \tau_2$ as roots. It factorizes into smaller polynomials and these two roots are in separate factors. Thus, we can go on with the right factor which we save in Rtau2. Then, we continue with the annihilating polynomial for μ .

```
> resultant(x*t-t2, subs(u=t, diff(P,u)), t);
> factor(resultant(%, subs(u=t2, Rtau2), t2));
```

We identify the algebraic relation for μ and save it in Rmu. Finally, we compute the minimal polynomial for κ_1 :

```
> Rmu:=2*u^5+4*u^4+6*u^3+8*u^2+10*u+5;
> Rk1:=resultant((x+1)*(u^4+2*u^3+3*u^2+4*u)+5, Rmu, u);
> factor(Rk1/igcd(coeffs(Rk1)));
```

$$-23x^5 + 41x^4 - 10x^3 + 6x^2 + x + 1$$

In conclusion, κ_1 is the unique real root of the polynomial $23x^5 - 41x^4 + 10x^3 - 6x^2 - x - 1$. Similar computations show that $(7/3)\kappa_2$ is the unique real root of the polynomial $11571875x^5 - 5363750x^4 + 628250x^3 - 97580x^2 + 5180x - 142$. The Galois group of each of these polynomials is S_5 . This implies that there is no closed-form formula for the Knuth constants κ_1 and κ_2 in terms of basic operations on integers, and roots of any degree.

In the next section we want to establish a link with the results from Nakamigawa and Tokushige. We will show how Knuth derived his problem and how to establish more such nice identities.

5.6 LINKS WITH THE WORK OF NAKAMIGAWA AND TOKUSHIGE

In this section, we show the connection between a result of Nakamigawa and Tokushige [147] and Knuth’s statement. Furthermore, we derive extensions of this result.

Let α, β be positive rational numbers. The Nakamigawa–Tokushige model consists of a single boundary $L : y = \alpha x + \beta$, and a lattice point⁸ $Q = (q_1, q_2) \in \mathbb{Z}^2$ on L , i.e., $q_2 = \alpha q_1 + \beta$. Furthermore the walks go in the opposite direction, i.e., they start in Q , use unit steps South and West (i.e., $(0, -1)$ and $(-1, 0)$, respectively), and end in the origin. Let V be the “vast” set of such walks without any restriction. The enumeration of V is a folklore result: $|V| = \binom{q_1+q_2}{q_1}$. Let $W \subset V$ be the set of walks which do not cross the line L and touch it only at Q .

Definition 5.6.1 (Nearest distance to the boundary). *Let $w \in V$ be a walk from a point Q to the point $(0, 0)$. We define the minimum y -distance $\delta(w)$ as follows: if the walk w touches or crosses the boundary $y = \alpha x + \beta$ after the first step, then let $\delta(w) = 0$, otherwise let $\delta(w)$ be the minimum of $\alpha p_1 + \beta - p_2$, where (p_1, p_2) runs over all lattice points on w except Q , see Figure 30.*

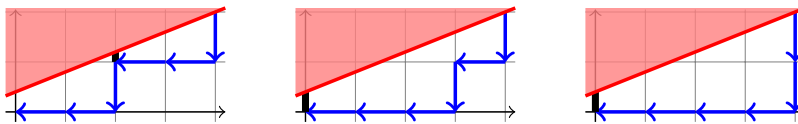

Figure 30: The 3 walks of length 6 in the $(2/5)x + 2/5$ model with $\delta(w) > 0$. The vertical bars mark the minimal y -distance $\delta(w)$. The first walk has $\delta(w) = 1/5$, whereas the last two have $\delta(w) = 2/5$. All of them are members of $W_{1/5}$, but only the two last ones belong to $W_{2/5}$.

Hence, we see that $\delta(w) = 0$ if and only if $w \in V \setminus W$, and so $\sum_{w \in V} \delta(w) = \sum_{w \in W} \delta(w)$. Note, if α and β are positive integers, then $\sum_{w \in V} \delta(w) = |W|$, because $\delta(w) = 1$ for all $w \in W$. This gives rise to the interpretation as a weighted sum corresponding to the number of walks.

For a real $t \geq 0$, let $W_t := \{w \in W \mid \delta(w) \geq t\}$, i.e., the walks staying at least a y -distance of t away from the boundary. Due to the

⁸ In the article [147], $Q = (m, n)$; we changed these coordinates in order to avoid a conflict with our other notations.

definition, $|W_t|$ is a left-continuous step function of t , and we get the representation

$$\int_0^1 |W_t| dt = \sum_{w \in V} \delta(w).$$

It is quite nice that this sum can be further simplified; this is what the next theorem states:

Theorem 5.6.2 (Nakamigawa–Tokushige lattice path integral). *Let q_1 and q_2 be positive integers, and let α, β be positive reals with $q_2 = \alpha q_1 + \beta$. Let V be the set of walks from the origin to the point⁹ (q_1, q_2) . Then, we have*

$$\int_0^1 |W_t| dt = \sum_{w \in V} \delta(w) = \frac{\beta}{q_1 + q_2} \binom{q_1 + q_2}{q_1}. \quad (131)$$

Proof. This corresponds to [147, Theorem 1 and Corollary 1], where it is proven using a cycle lemma approach. We give a generalization of this formula in the Section 5.7 hereafter, based on our kernel method approach, and Lagrange inversion. \square

A geometric bijection. If α is a rational slope, i.e., $\alpha = a/c$ for some $a, c \in \mathbb{N} \setminus \{0\}$, then

$$\int_0^1 |W_t| dt = \frac{1}{c} \sum_{t \in T} |W_t|, \quad (132)$$

where $T = \{\delta(w) \mid w \in W\} = \{1/c, 2/c, \dots, (c-1)/c\}$.

This gives rise to the following interpretation:¹⁰ If $w \in W$ then the first step is a South step. Then, let \tilde{w} be the walk obtained from w by omitting this step. Therefore, \tilde{w} is a walk with $q_1 + q_2 - 1$ steps, starting from $Q - (0, 1) = (q_1, q_2 - 1)$, and ending in the origin. We see that all these walks which never cross or touch L are in bijection with all walks in W . Now, take a walk $w \in W_t$ and its corresponding walk \tilde{w} . As $\delta(w) \geq t$, we can translate the barrier L by $t - 1/c$ down and the walk \tilde{w} still does not touch or cross this new barrier \tilde{L} . Hence, all walks in W_t are in bijection with walks from $(q_1, q_2 - 1)$ to the origin which stay strictly below the barrier \tilde{L} .

Example 5.6.3. This is the bijection that Knuth used in order to state his conjecture. In his case, we have $\alpha = \beta = 2/5$ and $q_1 = 5n - 1$, $q_2 = 2n$ for $n \in \mathbb{N} \setminus \{0\}$. We see that $q_2 = \alpha q_1 + \beta$. Hence, $a = 2$ and $c = 5$ which implies $T = \{1/5, 2/5, 3/5, 4/5\}$. In this case, the values $3/5$ and $4/5$ are playing no role, as $|W_{3/5}| = |W_{4/5}| = 0$ because $\beta = 2/5$ is the maximal value for $\delta(w)$ for all walks to the origin. Therefore, $\int_0^1 |W_t| dt$ can be represented by two summands involving

⁹ Nota bene: As proven in Lemma 5.6.4 (Possible starting points on the boundary), if α or β are irrational, then there is at most one such point. While if α and β are rational (with the right gcd condition), then there are infinitely many such points.

¹⁰ In the original work, a slightly different interpretation is given.

$W_{1/5}$ and $W_{2/5}$. They correspond to the two models A and B with the barriers $L_1 : y < (2/5)x + 2/5$ and $L_2 : y < (2/5)x + 1/5$, respectively where the paths start at $(5n - 1, 2n - 1)$ and move by South and West steps to the origin. Compare also Figure 30. Note that in Knuth’s case the walks move in the opposite direction, which is obviously equivalent.

In general, the number of summands $|W_t|$, which corresponds to the number of models in the equivalent formulation, is determined by the size of T minus the maximal y -distance at $(0, 0)$. Hence, we need to consider $\tilde{T} = \{t \in T \mid t < \beta\} = \{1/c, \dots, k/c\}$. This gives k models with walks from $(q_0, q_1 - 1)$ to the origin which stay strictly below the boundaries $L_i : y < \alpha x + (\beta - (i - 1)/c)$ for $i = 1, \dots, k$. Then, the above reasoning implies that the walks with boundary L_i correspond to the set $W_{i/c}$. Thus, counting the walks in these k models and summing them up, gives the binomial closed-form appearing in the lattice path integral theorem (131) divided by c , compare with (132).

Up to now in this section, we explained which different counting models are connected with the Nakamigawa–Tokushige lattice path integral formula. Now, we discuss the possible starting points on the boundary and their interplay with the (ir)rationality of the slope.

Lemma 5.6.4 (Possible starting points on the boundary). *Let α, β be positive reals. Then the equation $y = \alpha x + \beta$ possesses in the positive integers*

1. *infinitely many solutions (x, y) , if $\alpha = a/c$, $\beta = b/c$ with $a, b, c \in \mathbb{N}$, and $\gcd(a, c) \mid b$;*

$$x = cs - r_a, \quad y = as + r_c,$$

with $s \geq S_0 := \max(\lceil r_a/c \rceil, \lceil -r_c/a \rceil)$, and r_a and r_c are integers such that $r_a a + r_c c = b$;

2. *exactly one solution $(x, y) = (q_1, q_2)$, if $\alpha \notin \mathbb{Q}$ and $\beta = q_2 - \alpha q_1 > 0$;*
3. *no solution, otherwise.*

Proof. Let us start with rational slope $\alpha = a/c$, with $a, c \in \mathbb{N}$. In order to get integer solutions we need a rational $\beta = b/c$, with $b \in \mathbb{N}$. Then we need to find the solutions of the following linear Diophantine equation:

$$cy - ax = b. \tag{133}$$

These solutions exist if and only if $\gcd(a, c) \mid b$. By the extended Euclidean algorithm we get integers $r_a, r_c \in \mathbb{Z}$ such that

$$r_a a + r_c c = b.$$

This is done by computing numbers r'_a, r'_c such that $r'_a a / \gcd(a, c) + r'_c / \gcd(a, c) = 1$ and multiplying by b . All solutions are then given by the linear combination stated in the lemma. Due to the special form of (133) with a positive and a negative coefficient in front of the unknowns, it follows that for all $s \geq S_0$ the solutions are positive.

Finally, let α be irrational. Assume there exist two points $Q = (q_1, q_2)$ and $P = (p_1, p_2)$ fulfilling the assumptions. By taking the difference we get $q_2 - p_2 = \alpha(q_1 - p_1)$ which implies that for $q_1 \neq p_1$ we get the contradiction $\alpha \in \mathbb{Q}$. But for $q_1 = p_1$ it also holds that $p_2 = q_2$ and therefore $Q = P$.

It is easy to see that this solution exists if and only if $\beta = q_2 - \alpha q_1$ for arbitrary $q_1, q_2 \in \mathbb{N}$ as long as $\beta > 0$. \square

The previous lemma also appeared in [124], there, Kempner (of Kempner's series fame) also mentions that a similar claim holds for the number of algebraic rational (respectively algebraic) points on $y = \alpha x + \beta$ when α is algebraic (respectively transcendental) slope. The lemma gives us all possible integer solutions on a boundary with rational slope. With this knowledge we can reformulate the lattice path integral from Theorem 5.6.2 in order to give a more explicit result for all possible starting points and for any slope.

Theorem 5.6.5 (Lattice path integral and explicit binomial expression). *Let a, b, c be positive integers such that $\gcd(a, c) | b$. Let r_a, r_c be integers such that $r_a a + r_c c = b$. Then, $q_1(s) := cs - r_a$ and $q_2(s) := as + r_c$ define all pairs $(q_1(s), q_2(s))$ of integers on the barrier $L : y = \frac{a}{c}x + \frac{b}{c}$. Furthermore, let V be the set of walks from $(q_1(s), q_2(s))$ to the origin strictly below the barrier L . Then, we have*

$$\int_0^1 |W_t| dt = \frac{b/c}{(a+c)s + (r_c - r_a)} \binom{(a+c)s + (r_c - r_a)}{as + r_c}, \quad (134)$$

for $s \geq S_0 := \max(\lceil r_a/c \rceil, \lceil -r_c/a \rceil)$.

For fixed s the walks are ending after $q_1(s) + q_2(s) = (a+c)s + (r_c - r_a)$ steps, start at $(q_1(s), q_2(s))$ and go to the origin. In the equivalent formulation the walks start at $(q_1(s), q_2(s) - 1)$ and go to the origin, but we consider $k = c\beta = b$ different boundaries, given by

$$L_1 : y < \frac{a}{c}x + \frac{b}{c}, \quad L_2 : y < \frac{a}{c}x + \frac{b-1}{c}, \quad \dots, \quad L_b : y < \frac{a}{c}x + \frac{1}{c}.$$

Example 5.6.6. Returning to Knuth's model we have $y < \frac{2}{5}x + \frac{2}{5}$. Thus, the explicit values are $a = b = 2$ and $c = 5$ and the assumptions of Theorem 5.6.5 (Lattice path integral and explicit binomial expression) are satisfied, as $\gcd(a, c) = 1$. The Euclidean algorithm gives $r_a = -4$ and $r_c = 2$. From Lemma 5.6.4 on the possible starting point

on the boundary, we deduce the possible integer coordinates on the barrier L :

$$q_1(s) = 5s + 4, \quad q_2(s) = 2s + 2,$$

for $s \geq 0$ which represent the starting points of the walks. Finally, Theorem 5.6.5 directly gives the solution

$$\int_0^1 |W_t| dt = \frac{2/5}{7s+6} \binom{7s+6}{2s+2}.$$

This value can be equivalently interpreted as the number of walks in $k = 2$ models starting from $(5s + 4, 2s + 1)$ and moving to the origin below the barriers

$$L_1 : y < \frac{2}{5}x + \frac{2}{5}, \quad L_2 : y < \frac{2}{5}x + \frac{1}{5}.$$

This is exactly Knuth’s problem, where his index $t = s + 1$.

Formula (134) directly yields nice lattice path identities in the manner of Knuth’s problem. Yet, there are even more formulae of this type that we will reveal in the next section. But let us start with an interesting (everyday) problem first.

5.7 DUCHON’S CLUB AND OTHER SLOPES

Duchon’s club: slope 2/3 and slope 3/2

A Duchon walk is a Dyck path starting from $(0, 0)$, with East and North steps, and ending on the line $y = \frac{2}{3}x$ (see Figure 31). This model was analyzed by Duchon [73], and further investigated by Banderier and Flajolet [19], who called it the “Duchon’s club” model, as it can be seen as the number of possible “histories” of couples entering a club in the evening¹¹, and exiting in groups of 3. What is the number of possible histories (knowing the club is closing empty)? Well, this is exactly the number E_n of excursions with n steps $+2, -3$, or (by reversal of the time) the number of excursions with n steps $-2, +3$. This gives the sequence $(E_{5n})_{n \in \mathbb{N}} = (1, 2, 23, 377, 7229, 151491, 3361598, \dots)$ (OEIS A060941). In fact, these numbers E_n appeared already in the article by Bizley [41] (who gave some binomial formulae, as we explained in Section 5.1). Duchon’s club model should then be the Bizley–Duchon’s club model; Stigler’s law of eponymy strikes again.

One open problem in the article [73] was the following one: “The mean area is asymptotic to $Kn^{3/2}$, but the constant K can only be approximated to 3.43”. Our method allows to identify this mysterious constant:

¹¹ Caveat: There are no real life facts/anecdotes hidden behind this pun!

Theorem 5.7.1 (Area below Duchon lattice paths). *The average area below Duchon excursions of length n (lattice paths from 0 to 0, which jumps -2 and $+3$) is*

$$A_n \sim Kn^{3/2} \text{ where } K = \sqrt{15\pi}/2 \approx 3.432342124.$$

Proof. The approach of [21] gives an expression for $A(z) = \sum A_n z^n$ in terms of the two small roots $u_1(z)$ and $u_2(z)$ of $1 - z(1/u^2 + u^3) = 0$. Then, using the rotation law gives the singular behavior of $A(z)$, and therefore the asymptotics of A_n with the explicit constant K . \square

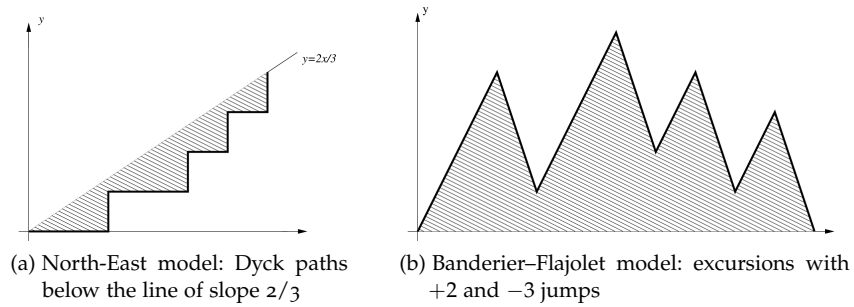

Figure 31: Dyck paths below the line of slope $2/3$ and Duchon's club histories (i.e., excursions with jumps $+2, -3$) are in bijection. Duchon conjectured that the average area (in gray) after n jumps is asymptotically equal to $Kn^{3/2}$; our approach shows that $K = \sqrt{15\pi}/2$.

Arbitrary rational slope

The closed-form for the coefficient (Theorem 5.4.2) generalizes to arbitrary rational slope:

Theorem 5.7.2 (General closed-forms for any rational slope). *Let a, b, c be integers such that $\gcd(a, c) | b$. Let $A_s(k)$ be the number of Dyck walks below the line of slope $y = \frac{a}{c}x + \frac{k}{c}$, ending at (x_s, y_s) given by*

$$x_s = cs - r_a, \quad y_s = as + r_c - 1,$$

where r_a and r_c are integers such that $r_a a + r_c c = b$. These numbers are non-negative for $s \geq S_0 := \max(\lceil r_a/c \rceil, \lceil -r_c/a \rceil)$. Then we have

$$\sum_{k=1}^b A_s(k) = \frac{b}{(a+c)s + (r_c - r_a)} \binom{(a+c)s + (r_c - r_a)}{as + r_c}.$$

Proof. This result is a direct consequence of Theorem 5.6.5 (lattice path integral and explicit binomial expression) and the geometric bijection (132). \square

The enumeration of lattice paths below the line $y = \frac{a}{c}x + \frac{b}{c}$ simplifies even more in the case $a = b$. Additionally, we are able to extend

the nice counting formula in terms of binomial coefficients. In order to get these nice formulae, let us first state what becomes the equivalent of Theorem 5.4.1 (Closed-form for the generating function) in the case of any rational slope.

Lemma 5.7.3 (Schur polynomial closed-form for meanders ending at a given altitude). *Let us consider walks in \mathbb{N}^2 with jumps $-a$ and $+c$ starting at altitude $h \geq a$. Let $u_1(z), \dots, u_a(z)$ be the small roots of the kernel equation $1 - zP(u) = 0$, with $P(u) = u^{-a} + u^c$. Let $F_0(z), \dots, F_{a-1}(z)$ be the generating functions of meanders ending at altitude $0, \dots, a - 1$, respectively. They are given by*

$$F_i(z) = \frac{(-1)^{a-i-1}}{z} s_{(h+1, 1^{a-i-1}, 0^i)}(u_1(z), \dots, u_a(z)),$$

where $s_\lambda(x_1, \dots, x_a)$ is a Schur polynomial, and $\lambda = (\lambda_1, \dots, \lambda_a)$ is an integer partition, i.e., $\lambda_1 \geq \lambda_2 \geq \dots \geq \lambda_a \geq 0$. The notation 1^s denotes s repetitions of 1.

Proof. Similar to (127) for the given step set the functional equation is given by

$$(1 - zP(u))F(z, u) = f_0(u) - zu^{-a}F_0(z) - zu^{-a+1}F_1(z) - \dots - zu^{-1}F_{a-1}(z).$$

Applying the kernel method, one may insert the a small branches into this equation. Then one gets a independent linear equations for the a unknowns $F_0(z), \dots, F_{a-1}(z)$. Expressing the solutions by Cramer’s rule and rearranging the determinants, one uncovers the defining expressions for the claimed Schur polynomials (see e.g. [174, Chapter 7.15] for an introduction to the relevant notions and notations). \square

Example 5.7.4. Let us consider the previous lemma for $a = 3$. We get the linear system

$$z \begin{pmatrix} 1 & u_1(z) & u_1(z)^2 \\ 1 & u_2(z) & u_2(z)^2 \\ 1 & u_3(z) & u_3(z)^2 \end{pmatrix} \begin{pmatrix} F_0(z) \\ F_1(z) \\ F_2(z) \end{pmatrix} = \begin{pmatrix} u_1(z)^{h+3} \\ u_2(z)^{h+3} \\ u_3(z)^{h+3} \end{pmatrix}.$$

Solving it with Cramer’s rule and rearranging the determinants we get

$$F_0(z) = \frac{s_{(h+1,1,1)}(u_1, u_2, u_3)}{z}, \quad F_1(z) = -\frac{s_{(h+1,1,0)}(u_1, u_2, u_3)}{z},$$

$$F_2(z) = \frac{s_{(h+1,0,0)}(u_1, u_2, u_3)}{z},$$

by the definition of Schur polynomials.

Now, we are able to extend the results of the closed-form for the sum of coefficients (Theorem 5.4.2) even further. At its heart lies the nice expression (130): $u_1^5 + u_2^5$. We will see that such a phenomenon holds in full generality, involving a sum of u_i^h .

Theorem 5.7.5 (General closed-forms for lattice paths below a rational slope $y = \frac{a}{c}x + \frac{b}{c}$, with b a multiple of a). Let a, c be integers such that $a < c$, and let b be a multiple of a . Let $A_s(k)$ be the number of Dyck walks below the line of slope $y = \frac{a}{c}x + \frac{k}{c}$, $k \geq 1$, ending at (x_s, y_s) given by

$$x_s = cs - 1, \quad y_s = as - 1.$$

Then it holds for $s \geq 1$ and $\ell \in \mathbb{N}$ such that $(\ell + 1)a < c$ that

$$\sum_{k=\ell a+1}^{(\ell+1)a} A_s(k) = \frac{\ell a + c}{(a + c)s + \ell - 1} \binom{(a + c)s + \ell - 1}{as - 1}.$$

Proof. Consider walks starting at $(0, 0)$, ending at (x_s, y_s) , and staying below the line $\frac{a}{c}x + \frac{1}{c}$. These are counted by $A_s(1)$. Let us transform such walks by adding a new horizontal jump at the end. Note that the first $\lfloor \frac{c}{a} \rfloor$ jumps must be horizontal jumps. Thus, we can interpret this walk as one starting from $(1, 0)$, ending at $(x_s + 1, y_s)$ staying below the given boundary. But as a horizontal jump increases the distance to the boundary by $\frac{a}{c}$ this is equivalent to counting walks starting at $(0, 0)$, ending at (x_s, y_s) , and staying below the boundary $\frac{a}{c}x + \frac{a+1}{c}$. This process is shown in Figure 32. Such walks are counted by $A_s(a + 1)$.

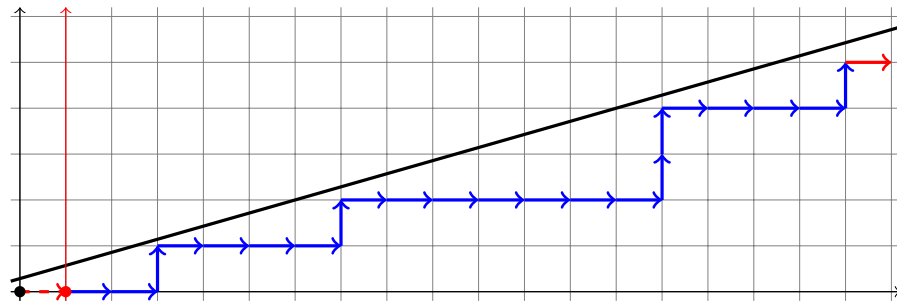

Figure 32: Transforming walks by moving the first step to the end of the walk. The red dot at $(1, 0)$ and the red y -axis mark the new origin.

Thus, the sequence $A_s(1), A_s(a + 1), A_s(2a + 1), \dots$ can be interpreted as counting walks staying always below the boundary $\frac{a}{c}x + \frac{1}{c}$, starting at $(0, 0)$, and ending at $(x_s, y_s), (x_s + 1, y_s), (x_s + 2, y_s), \dots$, respectively. In particular, for $\ell \geq 0$ we define these new ending points as $(\tilde{x}_s, \tilde{y}_s)$ given by

$$\tilde{x}_s = x_s + \ell = cs + \ell - 1, \quad \tilde{y}_s = y_s = as - 1.$$

Analogously, the same holds for $A_s(2), \dots, A_s(a - 1)$.

For the start, we then follow the line of thought from Theorem 5.4.2 (Closed-form for the sum of coefficients). Let us first derive the respective generating functions. Therefore, we apply the bijection from Proposition 5.3.1, reverse the time, and allow to touch $y = 0$. Then the sum $\sum_{k=\ell a+1}^{(\ell+1)a} A_s(k)$ can be interpreted as walks of length $\tilde{x}_s + \tilde{y}_s =$

$(a + c)s + \ell - 2$, starting at altitude $a\tilde{x}_s - c\tilde{y}_s + i = \ell a + (c - a) + i$, and ending at altitude i for $i = 0, \dots, a - 1$. To simplify notation, let us introduce the constant

$$h := \ell a + c.$$

Then, walks end at $h - a + i$. Therefore, we are now able to apply Lemma 5.7.3 (Schur polynomial closed-form for meanders ending at a given altitude). Additionally, by reversing the summation order we get:

$$\begin{aligned} \sum_{k=\ell a+1}^{(\ell+1)a} A_s(k) &= [z^{(a+c)s+\ell-2}] \sum_{j=0}^{a-1} \frac{(-1)^j}{z} s_{(h-j, 1^j, 0^{a-j-1})}(u_1(z), \dots, u_a(z)) \\ &= [z^{(a+c)s+\ell-1}] \left(\sum_{i=1}^a u_i(z)^h \right). \end{aligned} \tag{135}$$

This surprisingly simple result is due to a nice representation theorem of power symmetric functions in terms of Schur polynomials: [174, Theorem 7.17.1]. One gets this equation by setting $\mu = \emptyset$ and restricting the case to a variables. Note that this is the analog of (130). It is in one sense the reason for the nice closed-forms in this chapter.

In contrast to Theorem 5.4.2 (Closed-form for the sum of coefficients), we proceed now differently by Lagrange inversion [135]. From the kernel method, we know that the small branches $u_i(z)$ satisfy the kernel equation $1 - zP(u) = 0$, where $P(u) = u^{-a} + u^c$ for general slope a/c . The entire form of the kernel equation satisfies nearly a Lagrangean scheme

$$u_i(z)^a = z(1 + u_i(z)^{a+c}).$$

By taking the a -th root, one gets for an auxiliary power series $U(x)$:

$$U(x) = x\phi(U(x)), \quad \text{with} \quad \phi(u) = (1 + u^{a+c})^{1/a}.$$

Let $\omega \neq 1$ be an a -th root of unity (i.e., $\omega^a = 1$). Then we recover the $u_i(z)$, $i = 1, \dots, a$, by

$$u_i(z) = U(\omega^{i-1}z^{1/a}).$$

Thus, coming back to (135) we are actually interested in

$$\begin{aligned} \sum_{i=1}^a u_i(z)^h &= \sum_{i=1}^a U(\omega^{i-1}z^{1/a})^h = \sum_{n \geq 0} U_n z^{n/a} \left(\sum_{i=1}^a \omega^{(i-1)n} \right) \\ &= a \sum_{n \geq 0} U_{an} z^n, \end{aligned}$$

where $U(x)^h = \sum_{n \geq 0} U_n x^n$ (in fact, by construction many coefficients U_n are 0, because $U(z)$ has an $(a + c)$ periodic support, but this is not

altering our reasoning hereafter). Considering (135) again, we need U_{an} for $n = (a+c)s + \ell - 1$. It is determined by the above Lagrangean scheme:

$$\begin{aligned} U_{an} &= [x^{a((a+c)s+\ell-1)}]U(x)^h \\ &= \frac{\ell a + c}{a((a+c)s + \ell - 1)} [u^{a((a+c)s+\ell-1)-1}] u^{\ell a + c - 1} (1 + u^{a+c})^{(a+c)s+\ell-1} \\ &= \frac{\ell a + c}{a((a+c)s + \ell - 1)} \binom{(a+c)s + \ell - 1}{as - 1}. \end{aligned}$$

By the symmetry of the binomial coefficient the claim holds. \square

Example 5.7.6. Knuth's original problem was dealing with boundaries $y = \frac{2}{5}x + \frac{k}{5}$, ($k = 1, \dots, 4$). In particular, we may choose $\ell = 0$, and $\ell = 1$ to get:

$$\begin{aligned} \sum_{k=1}^2 A_s(k) &= \frac{5}{7s-1} \binom{7s-1}{2s-1} = \frac{2}{7s-1} \binom{7s-1}{2s}, \\ \sum_{k=3}^4 A_s(k) &= \frac{1}{s} \binom{7s}{2s-1}. \end{aligned}$$

The first one is the known result, whereas the second one is yet another surprising identity.

Now, we come back to the asymptotics of Section 5.5. Some key ingredients were Proposition 5.5.4 (Periodic rule of thumb) and the rotation law of the small branches. Happily, such a rotation law holds in general for any slope, and the derived techniques can also be applied. This is what we present now.

Let $P(u) = u^{-a} + u^c$ be the jump polynomial of directed walks. Thus, we have a small branches $u_i(z)$ satisfying the kernel equation $1 - zP(u_i(z)) = 0$. As before let τ be the unique positive root of $P'(\tau)$, and let ρ be defined as $\rho = 1/P(\tau)$. Recall that the small branches are possibly singular only at the roots of $P'(u)$. The jump polynomial has periodic support with period $p = a + c$ as $P(u) = u^{-a}H(u^p)$ with $H(u) = 1 + u$. Hence, there are p possible singularities of the small branches

$$\zeta_k = \rho\omega^k, \quad \text{with} \quad \omega = e^{2\pi i/p}.$$

The general version of Lemma 5.5.1 reads then as follows:

Lemma 5.7.7 (Rotation law of small branches). *Let $\gcd(a, c) = 1$. Then there exists a permutation σ of $\{1, \dots, p\}$ without fix points and an integer κ (satisfying $\kappa a + 1 \equiv 0 \pmod{p}$) such that*

$$u_i(\omega z) = \omega^\kappa u_{\sigma(i)}(z),$$

for all $z \in \mathbb{C}$ with $|z| \leq \rho$ and $0 < \arg(z) < \pi - 2\pi/p$.

Proof. We proceed as in the proof of Lemma 5.5.1. Define $U(z) := \omega^\kappa u_i(\omega z)$ and a function $X(z) := U^a - z\phi(U)$ with $\phi(u) := u^a P(u)$. Then a straightforward computation shows that

$$X(z) = (\omega^\kappa u_i(\omega z))^a - z\phi(\omega^\kappa u_i(\omega z)) = \omega^{\kappa a} u_i(\omega z)^a - z\phi(u_i(\omega z)),$$

as $\phi(u)$ is p -periodic. Therefore, we get by the following transformation

$$\omega X(z/\omega) = \omega^{\kappa a + 1} u_i(z)^a - z\phi(u_i(z)) = 0,$$

if $\kappa a + 1 \equiv 0 \pmod p$, because of the kernel equation. Thus, $X = U^a - z\phi(U) = 0$ and therefore $U(z)$ is a root of the kernel equation. It has to be a small root, as it is converging to 0 if z goes to 0. Furthermore, it has to be a different root, as it has a different Puiseux expansion. By the analytic continuation principle (as long as we avoid the cut line $\arg(z) = -\pi$) the result follows. \square

The last lemma allows us to state the following “meta”-result:

Paradigm 5.7.8 (Rule of thumb: enumeration and asymptotics of lattice paths). *Constrained 1-dimensional lattice paths have an algebraic generating function, expressible in terms of Schur functions (a symmetric function involving the small branches of the kernel). Singularity analysis gives its asymptotic behavior, which is equal to the asymptotics at the dominant real singularity (times the periodicity whenever the rotation law holds).*

We call this a paradigm because it is rather informal in the description of the constraints allowed (it could be positivity, prescribed starting or ending points, to live in a cone, to stay below a line of rational slope, to have some additional Markovian behavior, to be multidimensional with one border, or in bijection with any of these constraints...), in all these cases the spirit of the kernel method and analytic combinatorics should give the enumeration and the asymptotics. Different incarnations of this rule of thumb appear in [17, 19, 21, 24, 44], and no doubt that many new lattice problems on the one hand, and many new combinatorial problems involving some type of periodicity on the other hand, will offer additional incarnations of this paradigm.

5.8 CONCLUSION

In this chapter, we analyzed some models of directed lattice paths below a line of rational slope. As a guiding thread, we first illustrated our method on Dyck paths below the line of slope $2/5$. Beside the (pleasant) satisfaction of answering a problem of Don Knuth, this sheds light on properties of constrained lattice paths, including the delicate case (for analysis) of a periodic behavior.

We can shortly recall the main methods used in this chapter to attack lattice path problems:

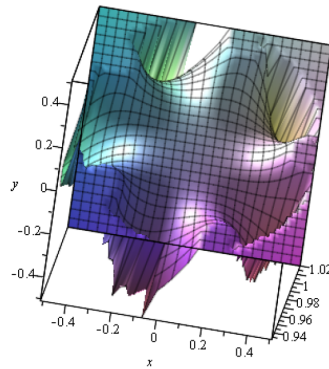

This is the landscape in the complex plane of $|F(z)|$, where $F(z)$ is here the generating function of Duchon's club excursions. One can see the five dominant singularities. It is enough to know the local behavior near the real positive singularity, the rotation law implies the same behavior at the other dominant singularities.

Figure 33: Landscape in the complex plane of the generating function of lattice paths.

Firstly, the method of choice of Nakamigawa and Tokushige was the *cycle lemma*. It is a classical result for lattice paths which uses the geometry of the problem. However, its applications are limited to certain cases.

Secondly, a more general result is given in Theorem 5.7.5 (General closed-forms for lattice paths below a rational slope $y = \frac{a}{c}x + \frac{b}{c}$), via the *Lagrange inversion*. This directly gives the sought closed-form. However, it does not give access to the asymptotics.

Thus, thirdly, we used the *kernel method* to express the generating functions explicitly in terms of (known) algebraic functions. This gave us access to the asymptotics, and is an alternative way to access the closed-forms. Our Proposition 5.5.4 (Periodic rule of thumb) explains in which way the asymptotic expansions are modified in the case of a periodic behavior (via some local asymptotics extractor and the rotation law); we expect this approach to be reused in many other problems.

Also, the method of *holonomy theory* used in Theorem 5.4.2 (Closed-form for the sum of coefficients) shows the possible usage of computer algebra to *prove* such *conjectured* identities. This is probably the fastest technique for checking given identities, and can be automated to a great extent. The interested reader is referred to the nicely written introductions [122, 156].

Our approach extends to any lattice path (with any set of jumps of positive coordinates) below a line of (ir)rational slope (see [31]). This leads to some nice universal results for the enumeration and asymptotics. As an open question, it could be natural to look for similar results for lattice paths (with any set of jumps with positive and negative coordinates, and not just jumps to the nearest neighbors) in a cone given by two lines of rational slope. This is equivalent to the enumeration of non-directed lattice paths in dimension 2. Despite the nice approach from the probabilistic school [59, 78] and from the com-

binomial school [49] via the iterated kernel method, this remains a terribly simple problem (to state!), but a challenge for the mathematics of this century.

6

LATTICE PATHS WITH CATASTROPHES

This chapter is based on joint work with Cyril Banderier. A preliminary version of the presented results has been published in the Proceedings of the 10th edition of Génération Aléatoire de Structures COMbinatoires (GASCom 2016) [29].

Lattice paths are a natural model in queuing theory: indeed, the evolution of a queue can be seen as a sum of jumps [80]. In this chapter, we consider jumps restricted to a given finite set of integers \mathcal{S} , where each jump $j \in \mathcal{S}$ is associated with a weight (or probability) p_j . The evolution of a queue naturally corresponds to lattice paths constrained to be non-negative. For example, if $\mathcal{S} = \{-1, +1\}$, this corresponds to the so-called Dyck paths. Moreover, we also consider the model where “catastrophes” are allowed.

Definition 6.0.1. A catastrophe is a jump $j \notin \mathcal{S} \cup \{0\}$ to altitude 0, see Figure 34.

Such a jump corresponds to a “reset” of the queue. The model of queues with catastrophes was e.g. considered in [112, 131].

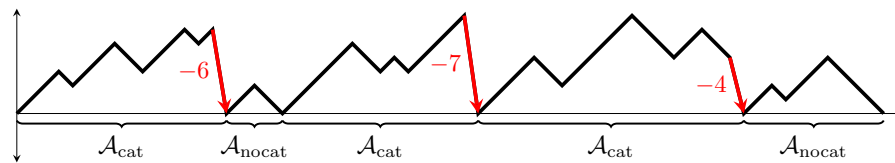

Figure 34: Decomposition of a Dyck path with 3 catastrophes into 5 arches. \mathcal{A}_{cat} stands for an “arch ending with a catastrophe” (a walk for which the first return to altitude 0 is a catastrophe), while $\mathcal{A}_{\text{nocat}}$ stands for an “arch with no catastrophe”.

Link with a continued fraction expansion. We first start with the observation that the generating function of these lattice paths have the following continued fraction expansion:

$$H(z) = \sum_{n \geq 0} h_n z^n = \frac{1}{1 - \frac{z^2}{1 - z - \frac{z^2}{1 - \frac{z^2}{1 - \frac{z^2}{1 - \ddots}}}}}$$

We give two proofs of this phenomenon in Theorem 6.2.1. In this chapter, we also tackle the question of what happens for more gen-

eral jumps than Dyck paths, and we give the enumeration and asymptotics of the corresponding lattice path models.

Link with generating trees. In combinatorics, such lattice paths are related to generating trees, which are a convenient tool to enumerate and generate many combinatorial structures in some incremental way (like e.g. permutations avoiding some pattern) [186]. In such trees, the distribution of the children of each node follows exactly the same dynamics as lattice paths with some “extended” jumps, as was intensively investigated by the Florentine school of combinatorics [35, 72, 81]. For example, the “extended” jumps can be a continuous set of jumps (from altitude k , one can jump to any altitude between 0 and k , possibly with some weights, plus a finite set of bounded jumps) [13, 16, 18, 23].

Enumeration and asymptotics: why context-free grammars would be a wrong idea here. Our lattice paths with catastrophes correspond to random walks with a space-dependent drift, which is decreasing with higher altitude; this leads to some counter-intuitive behavior: unlike classical directed lattice paths, the limiting object is no more directly related to classical Brownian motion theory. One way to analyze them could be to use a context-free grammar approach [134]: this leads to a system of algebraic equations, and therefore we already know “for free” that the corresponding generating functions are algebraic. However, this system involves nearly $(c + d)^2$ equations (where c is the largest negative jump and d the largest positive jump), so solving it (with resultants or Gröbner bases) leads to computations taking a lot of time and memory (exponential in $(c + d)^2$): even for $c = d = 10$, the needed memory to compute the algebraic equation with this method would be more than the expected number of particles in the universe! Another drawback of this method is that it would be a “case-by-case” analysis: for each new set of jumps, one would have to do new computations from scratch. Hence, with this method, there is no way to access “universal” asymptotic results: while it is well known that algebraic functions have some asymptotics of the type $f_n \sim C.A^n n^\alpha$, only the “critical exponent” α can be proven to belong to some specific set (see [17]), and there is no hope to get an easy access to C and A with this context-free grammar approach, in a way which is independent of a case-by-case computation (which would what is more be impossible for $c + d > 20$).

The solution: kernel method and analytic combinatorics. In this chapter, we offer an alternative to the context-free grammars. Our approach uses methods of analytic combinatorics for directed lattice paths: the kernel method and singularity analysis, see [19, 85]. It allows to get exact enumeration, the typical behavior of lattice paths with catastrophes, and has the advantage to offer universal results for the asymptotics and generic closed forms, whatever the set of jumps is.

Plan of this chapter. First, in Section 6.1, we present the model of walks with catastrophes and derive their generating functions. In Section 6.2, we establish a bijection between two classes of extensions of Dyck paths. In Section 6.3, we analyze our model in more detail and first derive the asymptotic number of excursions and meanders. Then we use these results to obtain limit laws for the number of catastrophes, the number of returns to zero, the final altitude, the total amplitude of catastrophes, and the average height of a catastrophe. We also introduce the perturbed supercritical composition scheme, which is applied repeatedly. In Section 6.4, we discuss the uniform random generation of such lattice paths. In Section 6.5, we state a summary of our results.

6.1 GENERATING FUNCTIONS

In this section, we give some explicit formulae for the generating functions of non-negative lattice paths with catastrophes, for which the set of jumps is encoded by $P(u) = \sum_{i=-c}^d p_i u^i$. For short, we call them “catastrophe-walks”. Every catastrophe is also assigned a weight $q > 0$.

Let us now show the influence on this model when allowing catastrophes. First we partition the jump set $\mathcal{S} = \mathcal{S}_+ \cup \mathcal{S}_- \cup \mathcal{S}_0$ into the set of positive jumps $j \in \mathcal{S}_+$ iff $j > 0$ and the set of negative jumps $j \in \mathcal{S}_-$ iff $j < 0$ and the possible zero jump $j \in \mathcal{S}_0$ iff $j = 0$.

Theorem 6.1.1 (Generating functions for lattice paths with catastrophes). *Let $f_{n,k}$ be the number of catastrophe-walks of length n from altitude 0 to altitude k , then the generating function $F(z, u) = \sum_{k \geq 0} F_k(z) u^k = \sum_{n,k \geq 0} f_{n,k} u^k z^n$ is algebraic and satisfies*

$$F(z, u) = D(z)M(z, u) = D(z) \frac{\prod_{i=1}^c (u - u_i(z))}{u^c (1 - zP(u))}, \quad (136)$$

$$F_k(z) = D(z)M_k(z) = D(z) \frac{1}{p_d z} \sum_{\ell=1}^d v_\ell^{-k-1} \prod_{j \neq \ell} \frac{1}{v_j - v_\ell}, \quad (137)$$

for $k \geq 0$, where $D(z) = \frac{1}{1-Q(z)}$ is the generating function of excursions ending with a catastrophe, $Q(z) = zq \left(M(z) - E(z) - \sum_{j \in \mathcal{S}_+} M_j(z) \right)$, and where, for any set of jumps encoded by $P(u)$, the u_i 's and the v_i 's are the small roots and the large roots of the kernel equation (52).

Proof. Take an arbitrary non-negative path of length n . Let ω_0 be the last time it returns to the x -axis with a catastrophe. This point gives a unique decomposition into an initial excursion which ends with a catastrophe (this might be empty), and a meander without any catastrophes. This directly gives the formulae (136).

What remains is to describe $D(z)$. Consider an arbitrary excursion ending with a catastrophe. We decompose it by its catastrophes, into a sequence of minimal excursions with catastrophes which we count by $Q(z)$. Such paths have only one catastrophe at their very ends and none before. Thus,

$$D(z) = \frac{1}{1 - Q(z)}. \tag{138}$$

Finally, we return to Definition 6.0.1. Thus, $Q(z)$ is given by the generating function of meanders that are not excursions nor meanders ending at altitudes $j \in \mathcal{S}_+$ followed by a final catastrophe. This implies the shape of $Q(z)$. \square

Technically, the generating function of excursions ending with a catastrophe $D(z)$ is a prefix of directed lattice paths.

Remark 19. Our results depend on the choice of Definition 6.0.1. The structure of the results does not change if a different definition is used. In particular, only the shape of $Q(z)$ would be affected. For example, one could consider allowing catastrophes from any altitude. This results in the change of $Q(z) = zqM(z)$. In order to ensure an easy adaptation to different models, we will state all our subsequent results in terms of a generic $Q(z)$.

Let us now consider an interesting class of lattice paths. A *Dyck meander* is a path constructed from the possible jumps $+1$ and -1 , each with weight 1, and being constrained to stay weakly above the x -axis. Accordingly, the polynomial encoding the jumps is $P(u) = u^{-1} + u$. Additionally, we set the weight of the catastrophe to 1.

Corollary 6.1.2 (Generating functions of Dyck paths with catastrophes). *The generating function of Dyck meanders with catastrophes, given by $F(z, 1) = \sum_{n \geq 0} m_n z^n$, satisfies*

$$\begin{aligned} F(z, 1) &= \frac{z(u_1(z) - 1)}{z^2 + (z^2 + z - 1)u_1(z)} \\ &= 1 + z + 2z^2 + 4z^3 + 8z^4 + 17z^5 + 35z^6 + \mathcal{O}(z^7), \end{aligned}$$

where $u_1(z) = \frac{1 - \sqrt{1 - 4z^2}}{2}$ is the solution of the kernel equation $1 - zP(u) = 0$ satisfying $\lim_{z \rightarrow 0} u_1(z) = 0$ (note that u_1 is also the generating functions of Catalan numbers). The generating function of Dyck excursions with catastrophes, given by $F_0(z) = \sum_{n \geq 0} e_n z^n$, satisfies

$$\begin{aligned} F_0(z) &= \frac{(2z - 1)u_1(z)}{z^2 + (z^2 + z - 1)u_1(z)} \\ &= 1 + z^2 + z^3 + 3z^4 + 5z^5 + 12z^6 + 23z^7 + \mathcal{O}(z^8). \end{aligned}$$

Moreover, e_{2n} is also the number of Dumont permutations of the first kind of length $2n$ avoiding the patterns 1423 and 4132 .

Proof. The formulae for $F(z, 1)$ and $F_0(z)$ are a direct application of Theorem 6.1.1. Then, we note that $(F_0(z) + F_0(-z))/2$ equals the generating function of Dumont permutations of the first kind of length $2n$ avoiding the patterns 1423 and 4132 (see [53] for the definition of such permutations, and the derivation of their generating function). \square

In the next section we will analyze Dyck paths with catastrophes in more detail. On the way we are able to solve some conjectures of the On-Line-Encyclopedia of Integer Sequences.

6.2 BIJECTION FOR DYCK PATHS WITH CATASTROPHES

The goal of this section is to establish a bijection between two classes of extensions of Dyck paths¹. Let us first recall the classical definition of Dyck paths: These are walks starting at altitude 0, constructed from the steps $(1, 1)$ and $(1, -1)$, which never go below the x -axis and end on the x -axis. Next, we consider two extensions (see Figure 35 for an illustration):

1. *Dyck paths with catastrophes* are Dyck paths with the additional option of jumping to the x -axis from any altitude $h > 1$; and
2. *1-horizontal Dyck paths* are Dyck paths with the additional allowed horizontal step $(1, 0)$ at altitude 1.

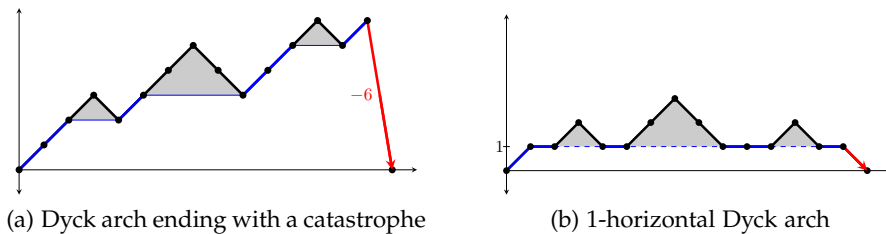

Figure 35: The bijection of Theorem 6.2.1 transforming Dyck arches ending with catastrophes into 1-horizontal Dyck arches, and vice versa.

Let e_n be the number of Dyck paths with catastrophes of length n , and let h_n be the number of 1-horizontal Dyck paths of length n . Then, one has

Theorem 6.2.1 (Bijection for Dyck paths with catastrophes). *The number of Dyck paths with catastrophes of length n is equal to the number of 1-horizontal Dyck paths of length n :*

$$e_n = h_n.$$

¹ We thus prove several conjectures by Alois P. Heinz, R. J. Mathar, and other contributors in the On-Line-Encyclopedia of Integer Sequences, see sequences A224747 and A125187 therein.

Proof. A first proof that $h_n = e_n$ consists in using the continued fraction point of view (each level $k + 1$ of the continued fraction encodes the jumps allowed at altitude k):

$$H(z) = \sum_{n \geq 0} h_n z^n = \frac{1}{1 - \frac{z^2}{1 - z - z^2 C(z)}},$$

where $C(z)$ is the generating function of classical Dyck paths, $C(z) = 1/(1 - z^2 C(z))$. One then gets that $H(z)$ equals the closed form of $F_0(z)$ given in Corollary 6.1.2.

We now also give a bijective procedure which transforms every Dyck path with catastrophes into a 1-horizontal Dyck path, and vice versa.

Every excursion can be decomposed into a sequence of “minimal” excursions, in the sense that their only contact with the x -axis is at the starting- and end point. Such paths are called *arches*, see Figure 34. There are two types of arches: arches ending with catastrophes $A_{\text{cat}}(z)$ and arches ending with a jump $j \in \mathcal{S}$ given by $A_{\text{nocat}}(z)$. This gives the alternative decomposition to (137) of the kind (compare also Figure 34)

$$F_0(z) = \frac{1}{1 - (A_{\text{cat}}(z) + A_{\text{nocat}}(z))}.$$

Thus, without loss of generality, we continue our discussion only for arches. The following procedure is visualized in Figure 35.

Let us start with an arbitrary arch of Dyck paths with catastrophes. It is either a classical Dyck path, and therefore also a 1-horizontal Dyck path, or it ends with a catastrophe of height h . First, we map the catastrophe with h up-steps $(1, 1)$. We draw horizontal lines to the left, until we hit an up-step. All but the first one are replaced by horizontal steps. Finally, we replace the catastrophe by a down step $(1, -1)$. All parts in between stay the same. Note, that we replaced $h - 1$ up-steps, and therefore lost a height of $h - 1$, but we also replaced the catastrophe of height h by a down-step, which represents a gain of height by $h - 1$. Thus, we again return to the x -axis. Furthermore, all horizontal steps are at altitude 1. Thus, we always stay weakly above the x -axis, and we got an arch of a 1-horizontal Dyck path.

The inverse mapping is analogous. □

The most important building blocks in the previous bijection were arches ending with a catastrophe. These can be made even more explicit.

Proposition 6.2.2 (Dyck arches ending with a catastrophe). *Let $A(z) = \sum_{n \geq 0} a_n z^n$ be the generating function of arches ending with a catastrophe. Then, one has the following closed-forms*

$$\begin{aligned} a_n &= \binom{n-2}{\lfloor \frac{n-3}{2} \rfloor}, \\ A_{\text{cat}}(z) &= z \frac{M(z) - E(z) - M_1(z)}{E(z)} \\ &= \frac{1}{2} \frac{2z^2 + z - 1 + \sqrt{(1-2z)(1+2z)(1-z)^2}}{1-2z} \\ &= z^3 + z^4 + 3z^5 + 4z^6 + 10z^7 + 15z^8 + 35z^9 + \mathcal{O}(z^{10}), \end{aligned}$$

where $M(z)$, $E(z)$ and $M_1(z)$ are the generating functions of classical Dyck walks for meanders, excursions, and meanders ending at 1, respectively.

Proof. Every excursion ending with a catastrophe can be uniquely decomposed into an initial excursion and a final arch with a catastrophe. By Theorem 6.1.1 we get the generating function of $A_{\text{cat}}(z) = \frac{Q(z)}{E(z)}$.

In order to compute a_n , we delete the final catastrophe-jump, and the initial +1-jump which is necessary for all such arches of positive length. The remaining part is Dyck meander (always staying weakly above the x -axis) that never comes back to the x -axis. Thus,

$$a_{n+2} = \underbrace{\binom{n}{\lfloor \frac{n}{2} \rfloor}}_{\text{meanders}} - \underbrace{\frac{1}{n/2+1} \binom{n}{\frac{n}{2}}}_{\text{excursions}} \llbracket n \text{ even} \rrbracket,$$

where $\llbracket P \rrbracket$ denotes the Iverson bracket, which is 1 if the condition P is true, and 0 otherwise. A simple calculation yields the final claim. \square

6.3 ASYMPTOTICS AND LIMIT LAWS

The natural model in which all paths of length n have the same distribution is therefore creating in return some probabilistic model on the probability of each jump, and for each altitude: the drift of the walk is then space-dependent, and converging to minus infinity when the altitude of the paths is increasing. So, unlike the easier classical Dyck paths (and their generalization via directed lattice paths, having a finite set of given jumps), we are losing the intuition offered by Brownian motion theory. This leads to the natural question of what are the asymptotics of the fundamental parameters of our “lattice paths with catastrophes”. This is the question we are going to answer now.

An important result of Banderier and Flajolet [19] are the asymptotic enumeration formulae for the four types of paths shown in Table 2. A fundamental result is the fact that the principal small branch $u_1(z)$ and the principal large branch $v_1(z)$ are conjugated to each other at their dominant singularity $\rho = \frac{1}{P(\tau)}$ where $\tau > 0$ is the minimal positive real solution of $P'(\tau) = 0$, compare (18).

Asymptotics of lattice paths

We start by analyzing the function $D(z) = \frac{1}{1-Q(z)}$, or respectively

$$Q(z) = zq \left(M(z) - E(z) - \sum_{j \in \mathcal{S}_+} M_j(z) \right).$$

In particular, we need to find its singularities, which are given by the behavior of its denominator.

Lemma 6.3.1. *The equation $1 - Q(z) = 0$ has at most one solution $\rho_0 > 0$ for $|z| \leq \rho$. For $\delta \geq 0$ this solution always exists and $\rho_0 < \frac{1}{p(1)} \leq \rho$. For $\delta < 0$ it depends on the value $Q(\rho)$:*

$$\begin{cases} \frac{1}{p(1)} < \rho_0 < \rho, & \text{for } Q(\rho) > 1, \\ \rho_0 = \rho, & \text{for } Q(\rho) = 1, \\ \nexists \rho_0, & \text{for } Q(\rho) < 1. \end{cases}$$

Proof. Note that $Q(z)$ has non-negative coefficients and is aperiodic. Thus, the strong triangle inequality $|Q(z)| < Q(|z|)$ holds. This implies, if existent, a unique minimal solution ρ_0 on the positive real axis.

Next, note that $Q(z)$ consists of 3 different parts: the generating function of meanders $M(z)$, the generating function of excursions $E(z)$, and the sum of meanders ending at fixed altitudes $\sum_{j \in \mathcal{S}_-} M_j(z)$. The functions $E(z)$ and $M_j(z)$ are analytic for $|z| < \rho$, but the behavior of $M(z)$ depends on the drift δ , see [19]. For $\delta \geq 0$ it possesses a simple pole at $\rho_1 := \frac{1}{p(1)} \leq \rho$. Thus, $\lim_{z \rightarrow \rho_1^-} Q(z) = +\infty$, and together with $Q(0) = 0$ this implies that there is a solution $0 < \rho_0 < \rho$.

For $\delta < 0$ we have that $|Q(z)|$ is bounded for $|z| < \rho$. Thus, for a fixed jump polynomial $P(u)$ any case can be attained by a variation of q . As $Q(z)$ is monotonically increasing on the real axis, it suffices to compare its value at its maximum $Q(\rho)$.

It remains to consider the lower bound in the case $Q(\rho) > 1$. Because of $u_1(\rho_1) = 1$ the singularity in the denominator is canceled by the factor $1 - u_1(z)$. Due to the domination property $|u_i(z)| < |u_1(z)| < 1$ for $z \in (0, \rho)$ the remaining factors are strictly smaller than 1. A detailed discussion of this behavior can be found in the proof of [19, Theorem 4]. □

Note that $Q(z)$ strongly depends on the weight of the catastrophes $q > 0$. Therefore, for a fixed step set $P(u)$ with negative drift one can model any of the three possible cases by a proper choice of q .

Theorem 6.3.2. *The asymptotics of excursions ending with a catastrophe d_n depends on the drift δ , the structural radius ρ , and ρ_0 :*

$$d_n = \begin{cases} \frac{\rho_0^{-n}}{\rho_0 Q'(\rho_0)} \left(1 + \mathcal{O}\left(\frac{1}{n}\right)\right), & \rho_0 < \rho, \\ \frac{\rho^{-n}}{\eta \sqrt{\pi n}} \left(1 + \mathcal{O}\left(\frac{1}{n}\right)\right), & \rho_0 = \rho \text{ (and } \delta < 0), \\ \frac{D(\rho)^2 \eta \rho^{-n}}{2\sqrt{\pi n^3}} \left(1 + \mathcal{O}\left(\frac{1}{n}\right)\right), & \not\equiv \rho_0 \text{ (and } \delta < 0), \end{cases}$$

where η is given by the Puiseux expansion of $Q(z) = Q(\rho) - \eta \sqrt{1 - z/\rho} + \mathcal{O}(1 - z/\rho)$ for $z \rightarrow \rho$. The last two cases are only possible for $\delta < 0$.

Proof. The singularity of $D(z)$ arises either at the minimum of ρ and ρ_0 . In the first case $\rho_0 < \rho$, the singularity is a simple pole as the first derivative of the denominator at ρ_0 is strictly positive. We get for $z \rightarrow \rho_0$

$$1 - Q(z) = \underbrace{(1 - Q(\rho_0))}_{=0} + \rho_0 Q'(\rho_0)(1 - z/\rho_0) + \mathcal{O}((1 - z/\rho_0)^2).$$

This yields a simple pole at ρ_0 and by singularity analysis we get the result.

By Lemma 6.3.1 the other cases are only possible for $\delta < 0$. For $\rho_0 = \rho$ or $\not\equiv \rho_0$ we get a square root behavior for $z \rightarrow \rho$

$$1 - Q(z) = (1 - Q(\rho)) + \eta \sqrt{1 - z/\rho} + \mathcal{O}(1 - z/\rho). \quad (139)$$

For $\rho_0 = \rho$ the constant term is 0, and we get for $z \rightarrow \rho$

$$D(z) = \frac{1}{\eta \sqrt{1 - z/\rho}} \left(1 + \mathcal{O}(\sqrt{1 - z/\rho})\right). \quad (140)$$

However, for $\not\equiv \rho_0$ the constant term does not vanish. This gives for $z \rightarrow \rho$

$$D(z) = D(\rho) - \eta D(\rho)^2 \sqrt{1 - z/\rho} + \mathcal{O}(1 - z/\rho). \quad (141)$$

Applying singularity analysis yields the result. \square

Remark 20. Basically, Lemma 6.3.1 is responsible for the previous asymptotics. In particular, the critical exponent α in the singular expansion $D(z) = (1 - z/r)^\alpha$ for $r = \rho_0$ or $r = \rho$, respectively, satisfies

- $\alpha = -1$ for $\rho_0 < \rho$,
- $\alpha = -1/2$ for $\rho_0 = \rho$,
- $\alpha = 1/2$ for $\not\equiv \rho_0$.

With the help of the last result we are able to derive the asymptotics of lattice paths with catastrophes. Let us state the result for excursions next.

Theorem 6.3.3. *The number of excursions with catastrophes e_n is asymptotically equal to*

$$e_n = \begin{cases} \frac{E(\rho_0)}{\rho_0 Q'(\rho_0)} \rho_0^{-n} \left(1 + \mathcal{O}\left(\frac{1}{n}\right)\right), & \rho_0 < \rho, \\ \frac{E(\rho)}{\eta} \frac{\rho^{-n}}{\sqrt{\pi n}} \left(1 + \mathcal{O}\left(\frac{1}{n}\right)\right), & \rho_0 = \rho, \\ \frac{F_0(\rho)}{2} \left(\sqrt{2 \frac{P(\tau)}{P''(\tau)}} \frac{1}{\tau} + \eta D(\rho)\right) \frac{\rho^{-n}}{\sqrt{\pi n^3}} \left(1 + \mathcal{O}\left(\frac{1}{n}\right)\right), & \not\leq \rho_0. \end{cases}$$

Proof. As $F_0(z) = D(z)E(z)$ the singularity is either at ρ_0 or $\rho = \frac{1}{P(\tau)}$. Combining the results from Theorem 6.3.2 and [19, Theorem 3] gives the result. Note that the cases $\rho_0 = \rho$ and $\not\leq \rho_0$ are only possible for $\delta < 0$. \square

Next we also state the asymptotics for the number of meanders. The only difference is the appearance of $M(z)$ instead of $E(z)$, and slight change of a factor $\frac{1}{\tau-1}$ instead of $\frac{1}{\tau}$ in the first term for the case $\not\leq \rho_0$.

Theorem 6.3.4. *The number of meanders with catastrophes m_n is asymptotically equal to*

$$m_n = \begin{cases} \frac{M(\rho_0)}{\rho_0 Q'(\rho_0)} \rho_0^{-n} \left(1 + \mathcal{O}\left(\frac{1}{n}\right)\right), & \rho_0 < \rho, \\ \frac{M(\rho)}{\eta} \frac{\rho^{-n}}{\sqrt{\pi n}} \left(1 + \mathcal{O}\left(\frac{1}{n}\right)\right), & \rho_0 = \rho, \\ \frac{F(\rho,1)}{2} \left(\sqrt{2 \frac{P(\tau)}{P''(\tau)}} \frac{1}{\tau-1} + \eta D(\rho)\right) \frac{\rho^{-n}}{\sqrt{\pi n^3}} \left(1 + \mathcal{O}\left(\frac{1}{n}\right)\right), & \not\leq \rho_0. \end{cases}$$

Proof. Analogous to the proof of Theorem 6.3.3 the result follows after some tiresome computations from the fact that $F(z,1) = D(z)M(z)$. Combining the results from Theorem 6.3.2 and [19, Theorem 4] gives the result. \square

Remark 21. In the previous proofs we needed that $P(u)$ is an aperiodic jump set. Otherwise, the generating function $Q(z)$ does not have a unique singularity on its radius of convergence, but several. In such cases one needs to consider all singularities and sum their contributions. It is a priori not clear if these yield a non-zero coefficient, thus extra care is necessary. A systematic approach which should also work in this case is introduced in [28].

However, the case $\rho_0 < \rho$ does not need the asymptotics of $Q(z)$. Thus, it also holds in the periodic case. Such a case is e.g. given by Dyck paths with $q = 1$.

Corollary 6.3.5. *The number of Dyck paths with catastrophes e_n , and Dyck meanders with catastrophes m_n is asymptotically equal to*

$$e_n = C_e \rho_0^{-n} \left(1 + \mathcal{O}\left(\frac{1}{n}\right)\right), \quad m_n = C_m \rho_0^{-n} \left(1 + \mathcal{O}\left(\frac{1}{n}\right)\right),$$

where $\rho_0 \approx 0.46557$ is the unique positive root of $\rho_0^3 + 2\rho_0^2 + \rho_0 - 1$, the constant $C_e \approx 0.10381$ is the unique positive root of $31C_e^3 - 62C_e^2 + 35C_e - 3$, and the constant $C_m \approx 0.32679$ is the unique positive root of $31C_m^3 - 31C_m^2 + 16C_m - 3$. Accordingly,

$$\mathbb{P}(\text{meander of length } n \text{ is an excursion}) = \frac{e_n}{m_n} \sim 0.31767.$$

Proof. We apply the results from Theorem 6.3.3. We directly get

$$\rho_0 = \frac{1}{6} \left(116 + 12\sqrt{93} \right)^{1/3} + \frac{2}{3} \left(116 + 12\sqrt{93} \right)^{-1/3} - \frac{2}{3} \approx 0.46557,$$

which is strictly smaller than $\rho_0 = 1/2$. The defining equations for these algebraic numbers are computed by resultants. The asymptotics of meanders is computed in the same way, where $C_m = \frac{M(\rho_0)}{\rho_0 Q'(\rho_0)}$. \square

Average number of catastrophes

In Theorem 6.1.1 we had seen that excursions consist of two parts: a prefix containing all catastrophes followed by the type of path one is interested. If we want to count the number of catastrophes, it suffices therefore to analyze this prefix given by $D(z)$. What is more, by (138) we know already how to count catastrophes: by counting occurrences of $Q(z)$. Thus, let $d_{n,k}$ be the number of excursions ending with a catastrophe of length n with k catastrophes, then

$$D(z, v) := \sum_{n,k \geq 0} d_{n,k} z^n v^k = \frac{1}{1 - vQ(z)}.$$

Let $c_{n,k}$ be the number of excursions with k catastrophes. Then, we get

$$C(z, v) := \sum_{n,k \geq 0} c_{n,k} z^n v^k = D(z, v)E(z). \tag{142}$$

Let X_n be the number of catastrophes in a random path of length n . In other words, the probability is defined by

$$\mathbb{P}(X_n = k) = \frac{[z^n v^k]C(z, v)}{[z^n]C(z, 1)}.$$

Theorem 6.3.6. *The number of catastrophes of a random excursion with catastrophes of length n admits a limit distribution, with the limit law being dictated by the relation between ρ_0 and ρ .*

1. *In the case of $\rho_0 < \rho$ the standardized random variable*

$$\frac{X_n - \mu n}{\sigma \sqrt{n}}, \quad \mu = \frac{1}{\rho_0 Q'(\rho_0)}, \quad \sigma^2 = \frac{\rho_0 Q''(\rho_0) + Q'(\rho_0) - \rho_0 Q'(\rho_0)^2}{\rho_0^2 Q'(\rho_0)^3},$$

converges in law to a standard Gaussian variable $\mathcal{N}(0, 1)$.

$$\lim_{n \rightarrow \infty} \mathbb{P} \left(\frac{X_n - \mu n}{\sigma \sqrt{n}} \leq x \right) = \frac{1}{\sqrt{2\pi}} \int_{-\infty}^x e^{-y^2/2} dy.$$

2. In the case of $\rho_0 = \rho$ the normalized random variable

$$\frac{X_n}{\vartheta\sqrt{n}}, \quad \vartheta = \frac{\sqrt{2}}{\eta},$$

converges in law to a Rayleigh distributed random variable with density $xe^{-x^2/2}$.

3. In the case that ρ_0 does not exist, the limit distribution is a discrete one:

$$\mathbb{P}(X_n = k) = \frac{(n\eta/\lambda + C/\tau)\lambda^n}{\eta D(\rho)^2 + C/\tau D(\rho)} \left(1 + \mathcal{O}\left(\frac{1}{n}\right)\right),$$

where $\lambda = Q(\rho)$, $C = \sqrt{2\frac{P(\tau)}{P'(\tau)}}$, and $\tau > 0$ the unique positive real root of $P'(u) = 0$. In particular, X_n converges to the random variable given by the law of $\eta \text{NB}(2, \lambda) + \frac{C}{\tau} \text{NB}(1, \lambda)$.

Proof. First, for $\rho_0 < \rho$ we see from (142) that we are in the case of a perturbed supercritical composition scheme from Proposition 2.3.6. It is supercritical because $Q(z)$ is singular at ρ_0 and $\lim_{z \rightarrow \rho_0} Q(z) = \infty$. The perturbation $E(z)$ is analytic for $|z| < \rho$, and the other conditions are also satisfied. Hence, we get convergence to a normal distribution.

Second, for $\rho_0 = \rho$, we start with the asymptotic expansion of $E(z)$ at $z \sim \rho$. Due to [19, Theorem 3] we have

$$E(z) = E(\rho) \left(1 - \frac{C}{\tau} \sqrt{1 - z/\rho}\right) + \mathcal{O}(1 - z/\rho), \tag{143}$$

for $z \sim \rho$. This implies by (139) the asymptotic expansion

$$\begin{aligned} \frac{1}{C(z, v)} &= \frac{1}{E(\rho)} \left((1 - v) + \eta \sqrt{1 - z/\rho} \right) \\ &\quad + \mathcal{O}(1 - z/\rho) + \mathcal{O}\left((1 - v) \sqrt{1 - z/\rho} \right), \end{aligned}$$

for $z \sim \rho$ and $v \sim 1$. The shape above is the one necessary for the limit scheme in [70, Theorem 1] which implies a Rayleigh distribution. By a variant of the implicit function theorem applied to the small branches, the function satisfies the analytic continuation properties. The other technical details are easy to check.

Third, we know by Theorem 6.3.2 that $D(z)$ possesses a square-root singularity. Thus, combining the expansions (141) and (143) we get the asymptotic expansion of $C(z, v)$, which is of the same type of a square root as the one from Theorem 6.3.3. Extracting coefficients with the help of singularity analysis and normalizing by the result of Theorem 6.3.3 shows the claim. \square

In the last case of a discrete limit law, the probability generating function is asymptotically equal to

$$\frac{\eta D(\rho, v)^2 + (C/\tau)D(\rho, v)}{\eta D(\rho)^2 + (C/\tau)D(\rho)} \left(1 + \mathcal{O}\left(\frac{1}{n}\right)\right).$$

Let us end this discussion with an application to Dyck paths.

Corollary 6.3.7. *The number of catastrophes of a random Dyck path with catastrophes of length n is normally distributed. The standardized version of X_n ,*

$$\frac{X_n - \mu n}{\sigma\sqrt{n}}, \quad \mu \approx 0.0708358118, \quad \sigma^2 \approx 0.05078979113,$$

where μ is the unique positive real root of $31\mu^3 + 31\mu^2 + 40\mu - 3$, and σ is the unique positive real root of $29791\sigma^6 - 59582\sigma^4 + 60579\sigma^2 - 2927$, converges in law to a Gaussian variable $\mathcal{N}(0, 1)$.

Average number of returns to zero

In order to count the number of returns to zero, we decompose $F_0(z)$ into a sequence of arches. Let $A(z)$ be the corresponding generating function. (Caveat: this is not the same generating function as $A(z)$ in Proposition 6.2.2.) Then,

$$A(z) = 1 - \frac{1}{F_0(z)}.$$

Let $g_{n,k}$ be the number of excursions with catastrophes of length n and k returns to zero. Then,

$$G(z, v) := \sum_{n,k \geq 0} g_{n,k} z^n v^k = \frac{1}{1 - vA(z)}.$$

From now on, let X_n be the number of returns to zero in a random path of length n . In other words, the probability is defined as

$$\mathbb{P}(X_n = k) = \frac{[z^n v^k]G(z, v)}{[z^n]G(z, 1)}.$$

Theorem 6.3.8. *The number of returns to zero of a random excursion with catastrophes of length n admits a limit distribution, with the limit law being dictated by the relation between ρ_0 and ρ .*

1. *In the case of $\rho_0 < \rho$ the standardized random variable*

$$\frac{X_n - \mu n}{\sigma\sqrt{n}}, \quad \mu = \frac{1}{\rho_0 A'(\rho_0)}, \quad \sigma^2 = \frac{\rho_0 A''(\rho_0) + A'(\rho_0) - \rho_0 A'(\rho_0)^2}{\rho_0^2 A'(\rho_0)^3},$$

converges in law to a standard Gaussian variable $\mathcal{N}(0, 1)$.

2. *In the case of $\rho_0 = \rho$ the normalized random variable*

$$\frac{X_n}{\vartheta\sqrt{n}}, \quad \vartheta = \sqrt{2} \frac{E(\rho)}{\eta},$$

converges in law to a Rayleigh distributed random variable with density $xe^{-x^2/2}$.

3. In the case that ρ_0 does not exist, the limit distribution is a negative binomial distribution $\text{NB}(2, \lambda)$:

$$\mathbb{P}(X_n = k) = \frac{n\lambda^n}{F_0(\rho)^2} \left(1 + \mathcal{O}\left(\frac{1}{n}\right) \right),$$

with $\lambda = A(\rho) = 1 - \frac{1}{F_0(\rho)}$.

Proof. The proof follows the same lines as the one of Theorem 6.3.6. As the same ideas are used, we omit the tedious calculations. \square

Again, we give the concrete statement for Dyck paths with catastrophes.

Corollary 6.3.9. *The number of returns to zero of a random Dyck path with catastrophes of length n is normally distributed. The standardized version of X_n ,*

$$\frac{X_n - \mu n}{\sigma\sqrt{n}}, \quad \mu \approx 0.1038149281, \quad \sigma^2 \approx 0.1198688826,$$

where μ is the unique positive real root of $31\mu^3 - 62\mu^2 + 35\mu - 3$, and σ is the unique positive real root of $29791\sigma^6 + 231\sigma^2 - 79$, converges in law to a Gaussian variable $\mathcal{N}(0, 1)$.

It is interesting to compare the results of Corollaries 6.3.7 and 6.3.9 for Dyck paths: more than 10% of all steps are returns to zero, and more than 7% are catastrophes. This implies that among all returns to zero approximately 70% are catastrophes and 30% are -1 -jumps.

Average final altitude

In this section we want to analyze the final altitude of a path after a certain number of steps. The *final altitude* of a path is defined as the ordinate of its endpoint. Theorem 6.1.1 already encodes this parameter in u :

$$F(z, u) = D(z)M(z, u), \quad M(z, u) = \frac{\prod_{i=1}^c (u - u_i(z))}{u^c(1 - zP(u))},$$

where $M(z, u)$ is the bivariate generating function of meanders.

Let X_n be the random variable for lattice paths with catastrophes of length n ending at altitude k . In other words, the probability is defined as

$$\mathbb{P}(X_n = k) = \frac{[z^n u^k]F(z, u)}{[z^n]F(z, 1)}.$$

Theorem 6.3.10. *The final altitude of a random lattice path with catastrophes of length n admits a discrete limit distribution:*

$$\lim_{n \rightarrow \infty} \mathbb{P}(X_n = k) = [u^k]\omega(u), \quad \text{where}$$

$$\omega(u) = \begin{cases} \prod_{\ell=1}^d \frac{1 - v_\ell(\rho_0)}{u - v_\ell(\rho_0)}, & \text{for } \rho_0 \leq \rho, \\ \frac{\eta D(\rho) + \frac{c}{\tau - u}}{\eta D(\rho) + \frac{c}{\tau - 1}} \prod_{\ell=1}^d \frac{1 - v_\ell(\rho)}{u - v_\ell(\rho)}, & \text{for } \not\leq \rho_0. \end{cases}$$

Proof. Let us distinguish three cases. First, in the case of $\rho_0 < \rho$ the function $D(z)$ is responsible for the singularity of $F(z, u)$. Thus, by [92, Problem 178] (see also [85, Theorem VI.12]) we get the asymptotic expansion

$$\lim_{n \rightarrow \infty} \frac{[z^n]F(z, u)}{[z^n]F(z, 1)} = \frac{M(\rho_0, u)}{M(\rho_0, 1)} = \prod_{\ell=1}^d \frac{1 - v_\ell(\rho_0)}{u - v_\ell(\rho_0)}.$$

For the other cases we require by Lemma 6.3.1 $\delta < 0$. Yet, then we know from [19, Theorem 6] that $M(z, u)$ admits a discrete limit distribution. In particular, $M(z, u)$ admits for $z \rightarrow \rho$ the expansion

$$M(z, u) = M(\rho, u) \left(1 + \frac{C}{u - \tau} \sqrt{1 - z/\rho} \right) + \mathcal{O}(1 - z/\rho).$$

In the second case and third case for $\rho_0 = \rho$ and $\nexists \rho_0$, we get by multiplying this expansion with the one of $D(z)$ from (140) and (141), respectively, the expansion of $F(z, u)$. Normalizing with the results of Theorem 6.3.4 yields the result. \square

Corollary 6.3.11. *The final altitude of a random Dyck path with catastrophes of length n admits a geometric limit distribution with parameter $\lambda = v_1(\rho_0)^{-1} \approx 0.6823278$:*

$$\mathbb{P}(X_n = k) \sim (1 - \lambda) \lambda^k.$$

The parameter is the unique positive real root of $\lambda^3 + \lambda - 1$ and given by

$$\lambda = \frac{1}{6} \left(108 + 12\sqrt{93} \right)^{1/3} - 2 \left(108 + 12\sqrt{93} \right)^{-1/3}.$$

Total amplitude of catastrophes

Another interesting parameter is the total amplitude of catastrophes of excursions of length n . Let $a_{n,k}$ be the number of excursions with catastrophes of length n and total amplitude of all catastrophes contained in the path of k . The bivariate generating function $A_{\text{tot}}(z, u) = \sum_{n,k \geq 0} a_{n,k} z^n u^k$ is given by

$$A_{\text{tot}}(z, u) = D(z, u)E(z), \quad \text{where}$$

$$D(z, u) = \frac{1}{1 - Q(z, u)}, \quad \text{and}$$

$$Q(z, u) = zq \left(M(z, u) - E(z) - \sum_{j \in \mathcal{S}_+} u^j M_j(z) \right).$$

The generating function $Q(z, u)$ keeps track of the altitudes of used catastrophes. The new parameter u does not influence the singular expansion of $Q(z)$ analyzed in Theorem 6.3.2. We get for $z \rightarrow \rho^-$ and $0 \leq u \leq 1$ the following expansion

$$Q(z, u) = Q(\rho, u) - \eta(u) \sqrt{1 - z/\rho} + \mathcal{O}(1 - z/\rho), \quad (144)$$

where $\eta(u)$ is a nonzero function, and in terms of the previous expansion of $Q(z)$ we have that $\eta(1) = \eta$.

Let X_n be the random variable for lattice paths with catastrophes of length n and total amplitude of catastrophes k . Then we have

$$\mathbb{P}(X_n = k) = \frac{[z^n u^k]F(z, u)}{[z^n]F(z, 1)}.$$

Theorem 6.3.12. *The total amplitude of catastrophes of a random excursion with catastrophes of length n admits a limit distribution, with the limit law being dictated by the relation between ρ_0 and ρ .*

1. *In the case of $\rho_0 < \rho$ the standardized random variable*

$$\frac{X_n - \mu n}{\sigma \sqrt{n}}, \quad \mu = \frac{Q_u(\rho_0, 1)}{\rho_0 Q_z(\rho_0, 1)},$$

$$\sigma^2 = \left(1 + \frac{\rho_0 Q_{uu}(\rho_0, 1)}{Q_z(\rho_0, 1)}\right) \mu^2 + \left(1 - \frac{2Q_{zu}(\rho_0, 1)}{Q_z(\rho_0, 1)} + \frac{Q_{zz}(\rho_0, 1)}{Q_z(\rho_0, 1)}\right) \mu,$$

converges for $\sigma^2 > 0$ in law to a standard Gaussian variable $\mathcal{N}(0, 1)$.

2. *In the case of $\rho_0 = \rho$ the normalized random variable*

$$\frac{X_n}{\vartheta \sqrt{n}}, \quad \vartheta = \sqrt{2} \frac{Q_u(\rho, 1)}{\eta},$$

converges in law to a Rayleigh distributed random variable with density $x e^{-x^2/2}$.

3. *In the case that ρ_0 does not exist, the limit distribution is discrete and given by:*

$$\lim_{n \rightarrow \infty} \mathbb{P}(X_n = k) = \frac{\eta(u)D(\rho, u)^2 + \frac{c}{\tau}D(\rho, u)}{\eta D(\rho)^2 + \frac{c}{\tau}D(\rho)}.$$

Proof. In the first case $\rho_0 < \rho$ we will use [85, Theorem IX.9] the meromorphic scheme, which is a generalization of Hwang’s quasi-powers theorem. In order to apply it we need to check three conditions. First, the *meromorphic perturbation condition*: We know already from the proof of Theorem 6.3.2 that ρ_0 is a simple pole. What remains is to show that in a domain $\mathcal{D} = \{(z, u) : |z| < r, |u - 1| < \varepsilon\}$ the function admits the following representation

$$A_{\text{tot}}(z, u) = \frac{B(z, u)}{C(z, u)},$$

where $B(z, u)$ and $C(z, u)$ are analytic for $(z, u) \in \mathcal{D}$. There exists a $\delta > 0$ such that $r := \rho_0 + \delta < \rho$. For this value the representation holds, as $B(z, u) = u^c(1 - zP(u))E(z)$ and $C(z, u) = u^c(1 - zP(u)) - zq \prod_{i=1}^c(1 - u_i(z))$ are only singular for $z = \rho$ or $u = 0$.

Next, the *non-degeneracy* $Q_u(\rho, 1)Q_z(\rho, 1) \neq 0$ is easily checked. It ensures the existence of a non-constant $\rho(u)$ analytic at $u = 1$, such that $1 - Q(\rho(u), u) = 0$.

Finally, the *variability condition* $r''(1) + r'(1) - r'(1)^2 \neq 0$ for $r(u) = \frac{\rho(1)}{\rho(u)}$ is also satisfied due to

$$\begin{aligned}\rho(1) &= \rho_0, & \rho'(1) &= -\frac{Q_u(\rho, 1)}{Q_z(\rho, 1)}, \\ \rho''(1) &= -\frac{1}{Q_z(\rho, 1)} (Q_{zz}(\rho, 1)\rho'(1) + 2Q_{z,u}(\rho, 1)\rho'(1) + Q_{uu}(\rho, 1)).\end{aligned}$$

This implies the claimed normal distribution. \square

Corollary 6.3.13. *The total amplitude of catastrophes of a random Dyck path with catastrophes of length n is normally distributed. The standardized version of X_n ,*

$$\frac{X_n - \mu n}{\sigma\sqrt{n}}, \quad \mu \approx 0.2938197987, \quad \sigma^2 \approx 0.5809693987,$$

where μ is the unique positive real root of $31\mu^3 + 62\mu^2 + 71\mu - 27$, and σ is the unique positive real root of $29791\sigma^6 - 59582\sigma^4 + 298411\sigma^2 - 159099$, converges in law to a Gaussian variable $\mathcal{N}(0, 1)$.

Amplitude of an average catastrophe

At the end of the discussion on parameters of our lattice paths with catastrophes, we want to determine the law behind the altitude of a random catastrophe among all lattice paths of length n . In other words, one draws uniformly at random a catastrophe among all possible catastrophes of all lattice paths of length n .

We can construct it from the generating function counting the number of catastrophes. It is given in (142) where each catastrophe is marked by a variable v .

Lemma 6.3.14. *The bivariate generating function $A_{\text{avg}}(z, u)$ counting the altitude of a random catastrophe among all excursions with catastrophes is given by*

$$A_{\text{avg}}(z, u) = E(z) + Q(z, u)D(z)^2E(z).$$

Proof. A random excursion with catastrophes either contains no catastrophes and is counted by $E(z)$, or it contains at least one catastrophe. In the latter we choose one of its catastrophes and its associated excursion ending with this catastrophe. Then we replace it with an excursion ending with a catastrophe whose altitude has been marked. This corresponds to

$$A_{\text{avg}}(z, u) = E(z) + \frac{Q(z, u)}{Q(z)} \frac{\partial}{\partial v} C(z, v) \Big|_{v=1}.$$

Computing this expression proves the claim. \square

As before we define a random variable X_n for our parameter as

$$\mathbb{P}(X_n = k) = \frac{[z^n u^k] A_{\text{avg}}(z, u)}{[z^n] A_{\text{avg}}(z, 1)}.$$

Due to the factor $Q(z, u)$ the situation is similar to final altitude in Section 6.3.

Theorem 6.3.15. *The altitude of a random catastrophe of a lattice path of length n admits a discrete limit distribution:*

$$\lim_{n \rightarrow \infty} \mathbb{P}(X_n = k) = [u^k] \omega(u), \quad \text{where}$$

$$\omega(u) = \begin{cases} Q(\rho_0, u), & \text{for } \rho_0 \leq \rho, \\ \frac{\frac{c}{\tau} + (\frac{c}{\tau} D(\rho)^2 + 2\eta D(\rho)^3) Q(\rho, u) + \eta(u) D(\rho)^2}{\frac{c}{\tau} + (\frac{c}{\tau} D(\rho)^2 + 2\eta D(\rho)^3) Q(\rho, 1) + \eta D(\rho)^2}, & \text{for } \not\leq \rho_0. \end{cases}$$

Proof. The proof is similar to the one of Theorem 6.3.10.

First, for $\rho_0 < \rho$ only $D(z)^2$ is singular at ρ_0 , where all other terms are analytic. Thus, by [92, Problem 178] the claim holds.

Second, in the case of $\rho_0 = \rho$ we combine the singular expansions (140), (143), and (144) to get

$$A_{\text{avg}}(z, u) = \frac{E(\rho) Q(\rho, u)}{\eta^2(1 - z/\rho)} + \mathcal{O}\left((1 - z/\rho)^{-1/2}\right).$$

In other words, the polar singularity of $D(z)^2$ dominates, and the situation is similar to the one before.

In the final case, $\not\leq \rho_0$, we again combine the singular expansions. Yet this time the expansion of $D(z)$ is given by (141). This implies a contribution of all terms, as all of them are singular at once and all of them have the same type of singularity. \square

Corollary 6.3.16. *The amplitude of a random catastrophe among all Dyck paths with catastrophes of length n admits a (shifted) geometric limit distribution with parameter $\lambda \approx 0.6823278$:*

$$\lim_{n \rightarrow \infty} \mathbb{P}(X_n = k) = \begin{cases} (1 - \lambda) \lambda^{k-2}, & \text{for } k \geq 2, \\ 0, & \text{for } k = 0, 1. \end{cases}$$

The parameter is the unique positive real root of $\lambda^3 + \lambda - 1$ and given by

$$\lambda = \frac{1}{6} \left(108 + 12\sqrt{93}\right)^{1/3} - 2 \left(108 + 12\sqrt{93}\right)^{-1/3}.$$

Comparing this result to the one for the final altitude of meanders in Corollary 6.3.11, we see that the type of the law is of the same nature (yet shifted for the amplitude of catastrophes), and that the parameter λ is the same.

6.4 UNIFORM RANDOM GENERATION

In order to generate our lattice paths with catastrophes, we can build on some key methods from the last 20 years. First, classical Dyck paths (and generalized Dyck paths) can be generated by pushdown-automata, or equivalently, by a context-free grammar. Then, using the recursive method of Flajolet–Zimmermann–Van Cutsem [87] (which can be seen as a wide generalization to combinatorial structures of what Hickey and Cohen [105] did for context-free grammars), such paths of length n can be generated in $\mathcal{O}(n \log n)$ average-time. Later, Goldwurm [99] proved that this can be done with the same time-complexity, with only $\mathcal{O}(n)$ memory.

The Boltzmann method introduced by Duchon–Flajolet–Louchard–Schaeffer in [74] is also a way to get a linear average-time random generator for paths of length within $[(1 - \epsilon)n, (1 + \epsilon)n]$. Unfortunately, our lattice paths with catastrophes are not recursive in the above sense and include some equations with a minus sign which prohibits the above mentioned approaches. For sure, it could be possible to generate lattice paths with catastrophes via a dynamic programming approach, but this would require $\mathcal{O}(n^3)$ bits in memory, our next theorem shows we can do much better:

Theorem 6.4.1 (Uniform random generation). *Dyck paths with catastrophes can be generated in linear time. Lattice paths with catastrophes of length n can be generated uniformly at random in time $\mathcal{O}(n^{3/2})$ and memory $\mathcal{O}(1)$.*

Proof. Via the bijection of Theorem 6.2.1, the approaches mentioned above can be applied to Dyck paths with catastrophes. For more general lattice paths with catastrophes, there is no (known) bijection with objects directly generated by a context-free grammar, so we give the following alternative: This relies on a generating tree approach [16], where each transition is computed via

$$\mathbb{P} \left(\begin{array}{l} \left\{ \begin{array}{l} \text{jump } j \text{ when at altitude } k, \text{ and length } m, \\ \text{ending at } 0 \text{ at length } n \end{array} \right. \right) = \frac{f_{m,k}^0 f_{n-(m+1),0}^{k+j}}{f_{n,0}^0},$$

where $f_{m,k}^i$ is the number of paths with catastrophes of length m , starting at altitude i and ending at altitude k . Then, for each pair (i, k) , the theory of D-finite functions applied to the algebraic functions (compare Theorem 1.2.15) derived similarly to Theorem 6.1.1 allows us to get the recurrence for the corresponding f_m (see e.g. [17]). In order to get the m -th term f_m of a P-recursive sequence, there is a $\mathcal{O}(\sqrt{m})$ algorithm due to Chudnovsky & Chudnovsky [56]. It is possible to win space complexity and bit complexity by computing the f_m 's in floating point arithmetic, instead of rational numbers (although all the f_m are integers, it is often the case that the leading term of the P-recursive recurrence is not 1, and thus it then implies rational number

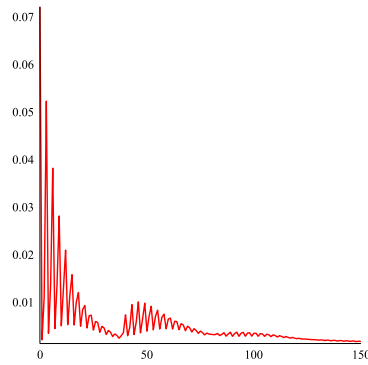

Figure 36: The limit law for the final altitude in the case of a jump polynomial $P(u) = u^{40} + 10u^3 + 2u^{-1}$. We observe a period 40, which is explained by a sum of 40 geometric-like basic limit laws.

computations, and time loss in gcd computations). Rounding errors can be corrected after the computations as the f_m 's have to be integers. All of this leads to a cost $\sum_{m=1}^n \mathcal{O}(\sqrt{m}) = \mathcal{O}(n^{3/2})$, moreover, a $\mathcal{O}(1)$ memory is enough to output the n jumps of the lattice path, step after step, as a stream. \square

6.5 CONCLUSION

In this chapter, motivated by a natural model from queuing theory where one allows a “reset” of the queue, we analyzed the corresponding combinatorial model: lattice paths with catastrophes. We showed how to enumerate them, how to get closed forms for their generating functions.

En passant, we gave a bijection (Theorem 6.2.1) which extends directly to lattice paths with a -1 jump and an arbitrary set of positive jumps, i.e. Łukasiewicz paths. It is known that the limiting objects associated to classical Dyck paths behave like Brownian excursions, Brownian meanders. It was therefore interesting to see what type of different behavior exhibit lattice paths with catastrophes; the results we gave for the asymptotics and the limit laws of several parameters illustrate these different behaviors. It is interesting to see that this leads to some apparently fractal like limit laws (see Figure 36), that we can in fact explain via our analytic combinatorics approach.

In conclusion, it is pleasant that the kernel method is once more allowing to solve a variant of lattice paths, giving the exact and asymptotic enumeration, and also leading to uniform random generation.

Part III

TREES AND TREE-LIKE STRUCTURES

This part concerns trees and tree-like structures. In Chapter 7 the classical theory of Pólya trees (unlabeled rooted trees which are considered up to symmetry) is revisited. According to a recent result they can be interpreted as conditioned critical Galton-Watson trees (or as a special class of weighted simply generated trees) attached with many small forests. These forests are with high probability of size $\mathcal{O}(\log n)$. First, this probabilistic result is put into a unified framework of analytic combinatorics by also improving certain bounds. Second, a combinatorial interpretation of the occurring rational weights is given. Chapter 8 treats the compactification of binary trees. A compacted tree is a tree in which every subtree is unique and repeatedly occurring subtrees are represented by pointers to existing ones. A calculus for generating functions is derived and used to solve the (asymptotic) counting problem.

7

A NOTE ON THE SCALING LIMITS OF RANDOM PÓLYA TREES

This chapter is based on joint work with Bernhard Gittenberger and Emma Yu Jin. A preliminary version of the presented results has been accepted for publication in the Proceedings of the ANALCO17 Barcelona Conference, [97].

Plan of this chapter. First of all, in Section 7.1 we recall Pólya trees and state a new interpretation in terms of a composition of two classes: C-trees and D-forests. In Section 7.2 we state our main results. In Section 7.3 we prove Theorem 7.2.1 and discuss the size of the C-tree C_n in a random Pólya tree T_n . In Section 7.4 we prove Theorems 7.2.2 and 7.2.3. In Section 7.5 we conclude with final remarks.

7.1 DECOMPOSING PÓLYA TREES

A *Pólya tree* is a rooted unlabeled tree considered up to symmetry. The *size* of a tree is given by the number of its nodes. We denote by t_n the number of Pólya trees of size n and by $T(z) = \sum_{n \geq 1} t_n z^n$ the corresponding ordinary generating function. By Pólya's enumeration theory, see Section 1.7 or [157], the generating function $T(z)$ satisfies

$$T(z) = z \exp \left(\sum_{i=1}^{\infty} \frac{T(z^i)}{i} \right).$$

We will see that $T(z)$ is connected with the *exponential generating function* of Cayley trees. "With a minor abuse of notation" (cf. [120, Example 10.2]), Cayley trees belong to the class of *simply generated trees*. Simply generated trees have been introduced by Meir and Moon [141] to describe a weighted version of rooted trees. They are defined by the functional equation

$$y(z) = z\Phi(y(z)), \quad \text{with} \quad \Phi(z) = \sum_{j \geq 0} \phi_j z^j, \quad \phi_j \geq 0.$$

The power series $y(x) = \sum_{n \geq 1} y_n x^n$ has non-negative coefficients and is the generating function of *weighted* simply generated trees. One usually assumes that $\phi_0 > 0$ and $\phi_j > 0$ for some $j \geq 2$ to exclude the trivial cases. In particular, in the above-mentioned sense, *Cayley trees* can be seen as simply generated trees which are characterized by $\Phi(z) = \exp(z)$. It is well known that the number of rooted Cayley trees of size n is given by n^{n-1} . Let

$$C(z) = \sum_{n \geq 0} n^{n-1} \frac{z^n}{n!},$$

be the associated exponential generating function. Then, by construction it satisfies $C(z) = z \exp(C(z))$. In contrast, Pólya trees are not simply generated (see [67] for a simple proof of this fact). Note that though $T(z)$ and $C(z)$ are closely related, Pólya trees are not related to Cayley trees in a strict sense, but to a certain class of weighted unlabeled trees which will be called C -trees in the sequel and have the ordinary generating function $C(z)$. This is precisely the simply generated tree associated with $\Phi(z) = \exp(z)$, now in the strict sense of the definition of simply generated trees.

In order to analyze the dominant singularity of $T(z)$, we follow [150, 157], see also [85, Chapter VII.5], and we rewrite (26) into

$$T(z) = ze^{T(z)}D(z), \quad \text{where} \quad (145)$$

$$D(z) = \sum_{n \geq 0} d_n z^n = \exp \left(\sum_{i=2}^{\infty} \frac{T(z^i)}{i} \right).$$

We observe that $D(z)$ is analytic for $|z| < \sqrt{\rho} < 1$ and that $\sqrt{\rho} > \rho$. From (145) it follows that $T(z)$ can be expressed in terms of the generating function of Cayley trees: Indeed, assume that $T(z)$ is a function $H(zD(z))$ depending on $zD(z)$. By (145) this is equivalent to $H(x) = x \exp(H(x))$. Yet, this is the functional equation for the generating function of Cayley trees. As this functional equation has a unique power series solution we have $H(x) = C(x)$, and we just proved

$$T(z) = C(zD(z)). \quad (146)$$

Note that $T(z) = C(zD(z))$ is a case of a super-critical composition scheme which is characterized by the fact that the dominant singularity of $T(z)$ is strictly smaller than that of $D(z)$. In other words, the dominant singularity ρ of $T(z)$ is determined by the outer function $C(z)$. Indeed, $\rho D(\rho) = e^{-1}$, because e^{-1} is the unique dominant singularity of $C(z)$.

Let us introduce two new classes of weighted combinatorial structures: D -forests and C -trees. We set $d_n = [z^n]D(z)$ which is the *accumulated weight* of all D -forests of size n . These are weighted forests of Pólya trees which are constrained to contain for every Pólya tree at least two identical copies or none. In other words, if a tree appears in a D -forest it has to appear at least twice. From (26) and (145) one gets its first values

$$D(z) = \sum_{n \geq 0} d_n z^n = 1 + \frac{1}{2}z^2 + \frac{1}{3}z^3 + \frac{7}{8}z^4 + \frac{11}{30}z^5 + \frac{281}{144}z^6 + \dots \quad (147)$$

The weights are defined in such a way that composition scheme (146) is satisfied. In Theorem 7.2.2 we will make these weights explicit.

$$d_n = \frac{1}{n} \sum_{i=2}^n d_{n-i} \sum_{\substack{m|i \\ m \neq i}} mt_m, \quad \text{for } n \geq 2,$$

as well as $d_0 = 1$, and $d_1 = 0$.

Next to D -forests, the second needed concept is the one of C -trees, which are weighted Pólya trees. The weight is defined by the composition (146). For this purpose, let $c_n = [z^n]C(z) = \frac{n^{n-1}}{n!}$ be the *accumulated weight* of all C -trees of size n . In other words, we interpret the exponential generating function of Cayley trees $C(z)$ as an ordinary generating function of *weighted* objects:

$$C(z) = \sum_{n \geq 0} \frac{n^{n-1}}{n!} z^n.$$

Informally speaking, the composition (146) can be interpreted as such that a Pólya tree is constructed from a C -tree where a D -forest is attached to each node.

This construction is in general not bijective, because the D -forests consist of Pólya trees and are not distinguishable from the underlying Pólya tree, see Figure 37. In general there are different decompositions of a given Pólya tree into a C -tree and D -forests. Theorem 7.2.2 will give a probabilistic interpretation derived from the automorphism group of a Pólya tree (see also Example 7.4.2).

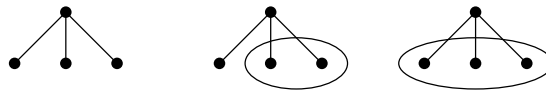

Figure 37: The decomposition of a Pólya tree with 4 nodes into a C -tree (non-circled nodes) and D -forests (circled nodes). For this Pólya tree there are 3 different decompositions.

7.2 MAIN RESULTS

Consider a random Pólya tree of size n , denoted by T_n , which is a tree that is selected uniformly at random from all Pólya trees with n vertices. We use C_n to denote the random C -tree that is contained in a random Pólya tree T_n . For every vertex v of C_n , we use $F_n(v)$ to denote the D -forest that is attached to the vertex v in T_n , see Figure 38.

Let L_n be the maximal size of a D -forest contained in T_n , that is, $|F_n(v)| \leq L_n$ holds for all v of C_n and the inequality is sharp. For the upper bound see also [151, Eq. (5.5)].

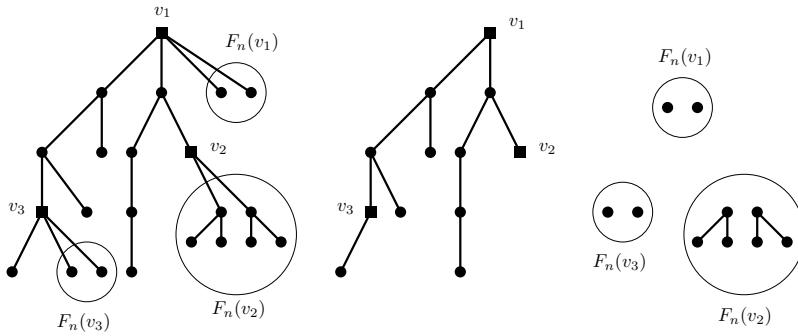

Figure 38: A random Pólya tree T_n (left), a (possible) C-tree C_n (middle) that is contained in T_n where all D -forests $F_n(v)$, except $F_n(v_1), F_n(v_2), F_n(v_3)$ (right), are empty.

Theorem 7.2.1. For $0 < s < 1$,

$$(1 - (\log n)^{-s}) \left(\frac{-2 \log n}{\log \rho} \right) \leq L_n \leq (1 + (\log n)^{-s}) \left(\frac{-2 \log n}{\log \rho} \right) \quad (148)$$

holds with probability $1 - o(1)$.

Our first main result is a new proof of Theorem 7.2.1 by applying the unified framework of Gourdon [100]. Our second main result is a combinatorial interpretation of all weights on the D -forests and C-trees in terms of automorphisms associated to a given Pólya tree.

Let $c_{n,k}$ denote the cumulative weight of all C-trees of size k that are contained in Pólya trees of size n . By $t_{c,n}(u)$ and $T_c(z, u)$ we denote the corresponding generating function and the bivariate generating function of $(c_{n,k})_{n,k \geq 0}$, respectively, that is,

$$t_{c,n}(u) = \sum_{k=1}^n c_{n,k} u^k \quad \text{and} \quad T_c(z, u) = \sum_{n \geq 0} t_{c,n}(u) z^n.$$

Note that $c_{n,k}$ is in general not an integer. By marking the nodes of all C-trees in Pólya trees we find a functional equation for the bivariate generating function $T_c(z, u)$, which is

$$\begin{aligned} T_c(z, u) &= zu \exp(T_c(z, u)) \exp\left(\sum_{i=2}^{\infty} \frac{T(z^i)}{i}\right) \\ &= zu \exp(T_c(z, u)) D(z). \end{aligned} \quad (149)$$

For a given permutation σ let σ_1 be the number of fixed points of σ . Our second main result is the following:

Theorem 7.2.2. Let \mathcal{T} be the set of all Pólya trees, and $\text{MSET}^{(\geq 2)}(\mathcal{T})$ be the multiset (or forest) of Pólya trees where each tree appears at least twice

if it appears at all. Then the cumulative weight d_n (defined in (147)) of all such forests of size n satisfies

$$d_n = \sum_{\substack{F \in \text{MSET}^{(\geq 2)}(\mathcal{T}) \\ |F|=n}} \frac{|\{\sigma \in \text{Aut}(F) \mid \sigma_1 = 0\}|}{|\text{Aut}(F)|},$$

where $\text{Aut}(F)$ is the automorphism group of F (see Definition 1.7.2). Furthermore, the polynomial associated to C -trees in Pólya trees of size n is given by

$$t_{c,n}(u) = \sum_{T \in \mathcal{T}, |T|=n} t_T(u), \quad \text{where } t_T(u) = \frac{1}{|\text{Aut}(T)|} \sum_{\sigma \in \text{Aut}(T)} u^{\sigma_1}.$$

In particular, for all $T \in \mathcal{T}$, we have $t'_T(1) = |\mathcal{P}(T)|$ where $\mathcal{P}(T)$ is the set of all trees which are obtained by pointing (or coloring) one single node in T .

For a given Pólya tree T the polynomial $t_T(u)$ gives rise to a probabilistic interpretation of the composition scheme (146). For a given tree the weight of u^k is the probability that the underlying C -tree is of size k . In other words, $t_T(u)$ is the probability generating function of the random variable C_T of the number of C -tree nodes in the tree T defined by

$$\mathbb{P}(C_T = k) := [u^k]t_T(u). \quad (150)$$

This random variable C_T is a refinement of T_n in the sense that

$$\mathbb{P}(C_T = k) = \mathbb{P}(|C_n| = k \mid T_n = T).$$

Finally, we derive the limiting probability that for a random node v the attached forest $F_n(v)$ is of a given size. This result is consistent with the Boltzmann sampler from [151]. The precise statement of our third main result is the following:

Theorem 7.2.3. *The generating function $T^{[m]}(z, u)$ of Pólya trees, where each vertex is marked by z , and each weighted D -forest of size m is marked by u , is given by*

$$T^{[m]}(z, u) = C(uzd_m z^m + z(D(z) - d_m z^m)), \quad (151)$$

where $d_m = [z^m]D(z)$. The probability that the D -forest $F_n(v)$ attached to a random C -tree node v is of size m is given by

$$\mathbb{P}(|F_n(v)| = m) = \frac{d_m \rho^m}{D(\rho)} \left(1 + \mathcal{O}\left(n^{-1}\right)\right).$$

7.3 THE MAXIMAL SIZE OF A D -FOREST

We will use the generating function approach from [100] to analyze the maximal size L_n of D -forests in a random Pólya tree T_n , which provides a new proof of Theorem 7.2.1. Following the same approach, we can establish a central limit theorem for the random variable $|C_n|$, which has been done in [177] for the more general random \mathcal{R} -enriched trees.

Proof of Theorem 7.2.1. In (5.5) of [151], only an upper bound of L_n is given. By directly applying Gourdon's results (Theorem 4 and Corollary 3 of [100]) for the super-critical composition scheme, we find that for any positive m ,

$$\mathbb{P}[L_n \leq m] = \exp\left(-\frac{c_1 n}{m^{3/2}} \rho^{m/2}\right) (1 + \mathcal{O}(\exp(-m\varepsilon))), \text{ where}$$

$$c_1 \sim \frac{b}{2\sqrt{\pi}(1-\sqrt{\rho})(D(\rho) + \rho D'(\rho))},$$

as $n \rightarrow \infty$. Moreover, the maximal size L_n satisfies asymptotically, as $n \rightarrow \infty$,

$$\mathbb{E}L_n = -\frac{2 \log n}{\log \rho} - \frac{3}{2} \frac{2}{\log \rho} \log \log n + \mathcal{O}(1) \quad \text{and} \quad \mathbb{V}L_n = \mathcal{O}(1).$$

By using Chebyshev's inequality, one can prove that L_n is highly concentrated around the mean $\mathbb{E}L_n$. We set $\varepsilon_n = (\log n)^{-s}$ where $0 < s < 1$ and we get

$$\mathbb{P}(|L_n - \mathbb{E}L_n| \geq \varepsilon_n \cdot \mathbb{E}L_n) \leq \frac{\mathbb{V}L_n}{\varepsilon_n^2 \cdot (\mathbb{E}L_n)^2} = o(1),$$

which means that (148) holds with probability $1 - o(1)$. \square

It was shown in [177] that the size $|C_n|$ of the C-tree C_n in T_n satisfies a central limit theorem and $|C_n| = \Theta(n)$ holds with probability $1 - o(1)$. The precise statement is the following.

Theorem 7.3.1 [177, Eq. (3.9) and (3.10)], [151, Eq. (5.6)]. *The size of the C-tree $|C_n|$ in a random Pólya tree T_n of size n satisfies a central limit theorem where the expected value $\mathbb{E}|C_n|$ and the variance $\mathbb{V}|C_n|$ are asymptotically*

$$\mathbb{E}|C_n| = \frac{2n}{b^2\rho}(1 + \mathcal{O}(n^{-1})), \quad \text{and} \quad \mathbb{V}|C_n| = \frac{11n}{12b^2\rho}(1 + \mathcal{O}(n^{-1})).$$

Furthermore, for any s such that $0 < s < 1/2$, with probability $1 - o(1)$ we have

$$(1 - n^{-s}) \frac{2n}{b^2\rho} \leq |C_n| \leq (1 + n^{-s}) \frac{2n}{b^2\rho}. \quad (152)$$

Random Pólya trees belong to the class of random \mathcal{R} -enriched trees and we refer the readers to [177] for the proof of Theorem 7.3.1 in the general setting. Here we provide a proof of Theorem 7.3.1 to show the connection between a bivariate generating function and the normal distribution and to emphasize the simplifications for the concrete values of the expected value and variance in this case.

Proof of Theorem 7.3.1 (see also [177]). It follows from [66, Th. 2.23] that the random variable $|C_n|$ satisfies a central limit theorem. In the present case, we set $F(z, y, u) = zu \exp(y)D(z)$. It is easy to verify that $F(z, y, u)$ is an analytic function when z and y are near 0 and that $F(0, y, u) \equiv 0$, $F(x, 0, u) \not\equiv 0$ and all coefficients $[z^n y^m]F(z, y, 1)$ are real and non-negative. From [66, Th. 2.23] we know that $T_c(z, u)$ is the unique solution of the functional identity $y = F(z, y, u)$. Since all coefficients of $F_y(z, y, 1)$ are non-negative and the coefficients of $T(z)$ are positive as well as monotonically increasing, this implies that $(\rho, T(\rho), 1)$ is the unique solution of $F_y(z, y, 1) = 1$, which leads to the fact that $T(\rho) = 1$. Moreover, the expected value is

$$\begin{aligned} \mathbb{E}|C_n| &= \frac{nF_u(z, y, u)}{\rho F_z(z, y, u)} = \frac{[z^n] \partial_u T_c(z, u)|_{u=1}}{[z^n] T(z)} \\ &= \left([z^n] \frac{T(z)}{1 - T(z)} \right) ([z^n] T(z))^{-1} = \frac{2n}{b^2 \rho} (1 + \mathcal{O}(n^{-1})). \end{aligned}$$

The asymptotics are directly derived from (27). Likewise, we can compute the variance

$$\mathbb{V}|C_n| = \frac{[z^n] T(z) (1 - T(z))^{-3}}{[z^n] T(z)} - (\mathbb{E}|C_n|)^2 = \frac{11n}{12b^2 \rho} (1 + \mathcal{O}(n^{-1})).$$

Furthermore, $|C_n|$ is highly concentrated around $\mathbb{E}|C_n|$, which can be proved again by using Chebyshev's inequality. We set $\varepsilon_n = n^{-s}$ where $0 < s < 1/2$ and get

$$\mathbb{P}(|C_n| - \mathbb{E}|C_n| \geq \varepsilon_n \cdot \mathbb{E}|C_n|) \leq \frac{\mathbb{V}|C_n|}{\varepsilon_n^2 \cdot (\mathbb{E}|C_n|)^2} = \mathcal{O}(n^{2s-1}) = o(1),$$

which yields (152). \square

As a simple corollary, we also get the total size of all weighted D -forests in T_n . Let \mathcal{D}_n denote the union of all D -forests in a random Pólya tree T_n of size n .

Corollary 7.3.2. *The size of weighted D -forests in a random Pólya tree of size n satisfies a central limit theorem where the expected value $\mathbb{E}|\mathcal{D}_n|$ and the variance $\mathbb{V}|\mathcal{D}_n|$ are asymptotically*

$$\begin{aligned} \mathbb{E}|\mathcal{D}_n| &= n \left(1 - \frac{2}{b^2 \rho} \right) (1 + \mathcal{O}(n^{-1})), \quad \text{and} \\ \mathbb{V}|\mathcal{D}_n| &= \frac{11n}{12b^2 \rho} (1 + \mathcal{O}(n^{-1})). \end{aligned}$$

Theorem 7.3.1 and Corollary 7.3.2 tell us that a random Pólya tree T_n consists mostly of a C-tree (proportion $\frac{2}{b^2\rho}$ comprising $\approx 82.2\%$ of the nodes) and to a small part of D -forests (proportion $1 - \frac{2}{b^2\rho}$ comprising $\approx 17.8\%$ of the nodes). Furthermore, the average size of a D -forest $F_n(v)$ attached to a random C-tree vertex in T_n is $\frac{b^2\rho}{2} - 1 \approx 0.216$, which indicates that on average the D -forest $F_n(v)$ is very small, although the maximal size of all D -forests in a random Pólya tree T_n reaches $\Theta(\log n)$.

Remark 22. Let us describe the connection of (146) to the Boltzmann sampler from [151]. We know that $F(z, y, 1) = z\Phi(y)D(z)$ where $\Phi(x) = \exp(x)$ and $y = T(z)$. By dividing both sides of this equation by $y = T(z)$, one obtains from (145) that

$$1 = \frac{zD(z)}{T(z)} \exp(T(z)) = \exp(-T(z)) \sum_{k \geq 0} \frac{T^k(z)}{k!},$$

which implies that in the Boltzmann sampler $\Gamma T(x)$, the number of offspring contained in the C-tree C_n is Poisson distributed with parameter $T(x)$. As an immediate result, this random C-tree C_n contained in the Boltzmann sampler $\Gamma T(\rho)$ is a critical Galton-Watson tree since the expected number of offspring is $F_y(z, y, 1) = 1$ which holds only when $(z, y) = (\rho, 1)$.

7.4 D-FORESTS AND C-TREES

In order to get a better understanding of D -forests and C-trees, we need to return to the original proof of Pólya on the number of Pólya trees [157]. The important step is the treatment of tree automorphisms by the cycle index, see Section 1.7 for the needed concepts.

Proof of Theorem 7.2.2

By Pólya's enumeration theory [157], the generating function $T(z)$ satisfies the functional equation

$$\begin{aligned} T(z) &= z \sum_{k \geq 0} Z(S_k; T(z), T(z^2), \dots, T(z^k)) \\ &= z \sum_{k \geq 0} \frac{1}{k!} \sum_{\sigma \in S_k} (T(z))^{\sigma_1} (T(z^2))^{\sigma_2} \dots (T(z^k))^{\sigma_k}, \end{aligned}$$

which can be simplified to (25), the starting point of our research, by a simple calculation. However, this shows that the generating function of D -forests from (145) is given by

$$\begin{aligned} D(z) &= e^{\sum_{i=2}^{\infty} \frac{T(z^i)}{i}} = \sum_{k \geq 0} Z(S_k; 0, T(z^2), \dots, T(z^k)) \\ &= \sum_{k \geq 0} \frac{1}{k!} \sum_{\sigma \in S_k, \sigma_1=0} (T(z^2))^{\sigma_2} \dots (T(z^k))^{\sigma_k}. \end{aligned}$$

This representation enables us to interpret the weights d_n of D -forests of size n : A D -forest of size n is a multiset of k Pólya trees, where every tree occurs at least twice. Its weight is given by the ratio of fixed point free automorphisms over the total number of automorphisms. Equivalently, it is given by the number of fixed point free permutations $\sigma \in S_k$ of these trees rescaled by the total number of orderings $k!$.

Let \mathcal{T} be the set of all Pólya trees and $\text{MSET}^{(\geq 2)}(\mathcal{T})$ be the multiset of Pólya trees where each tree appears at least twice if it appears at all. Combinatorially, this is a forest without unique trees. Then, their weights are given by

$$d_n = \sum_{\substack{F \in \text{MSET}^{(\geq 2)}(\mathcal{T}) \\ |F|=n}} \frac{|\{\sigma \in \text{Aut}(F) \mid \sigma_1 = 0\}|}{|\text{Aut}(F)|}.$$

Example 7.4.1. The smallest D -forest is of size 2, and it consists of a pair of single nodes. There is just one fixed point free automorphism on this forest, thus $d_2 = 1/2$. For $n = 3$ the forest consists of 3 single nodes. The fixed point free permutations are the 3-cycles, thus $d_3 = 2/6 = 1/3$. The case $n = 4$ is more interesting. A forest consists either of 4 single nodes, or of 2 identical trees, each consisting of 2 nodes and one edge. In the first case we have 6 4-cycles and 3 pairs of transpositions. In the second case we have 1 transposition swapping the two trees. Thus, $d_4 = \frac{6+3}{24} + \frac{1}{2} = \frac{7}{8}$.

These results also yield a natural interpretation of C -trees. We recall that by definition

$$T_c(z, u) = \sum_{n \geq 0} t_{c,n}(u) z^n,$$

where $t_{c,n}(u) = \sum_k c_{n,k} u^k$ is the polynomial marking the C -trees in Pólya trees of size n . From the decompositions (146) and (149) we get the first few terms:

$$\begin{aligned} t_{c,1}(u) &= u, \\ t_{c,2}(u) &= u^2, \\ t_{c,3}(u) &= \frac{3}{2}u^3 + \frac{1}{2}u, \\ t_{c,4}(u) &= \frac{8}{3}u^4 + u^2 + \frac{1}{3}u. \end{aligned}$$

Evaluating these polynomials at $u = 1$ obviously returns $t_{c,n}(1) = t_n$, which is the number of Pólya trees of size n . Their coefficients, however, are weighted sums depending on the number of C -tree nodes. For a given Pólya tree there are in general several ways to decide what is a C -tree node and what is a D -forest node. The possible choices are encoded in the automorphisms of the tree, and these are responsible for the above weights as well.

Let T be a Pólya tree, and $\text{Aut}(T)$ be its automorphism group. For an automorphism $\sigma \in \text{Aut}(T)$ the nodes which are fixed points of σ are C -tree nodes. All other nodes are part of D -forests. Summing over all automorphisms and normalizing by the total number gives the C -tree generating polynomial for T :

$$t_T(u) = Z(\text{Aut}(T); u, 1, \dots, 1) = \frac{1}{|\text{Aut}(T)|} \sum_{\sigma \in \text{Aut}(T)} u^{\sigma_1}. \quad (153)$$

The polynomial of C -trees in Pólya trees of size n is then given by

$$t_{c,n}(u) = \sum_{T \in \mathcal{T}, |T|=n} t_T(u).$$

Example 7.4.2. For $n = 3$ we have 2 Pólya trees, namely the chain T_1 and the cherry T_2 . Thus, $\text{Aut}(T_1) = \{\text{id}\}$, and $\text{Aut}(T_2) = \{\text{id}, \sigma\}$, where σ swaps the two leaves but the root is unchanged. Thus,

$$\begin{aligned} t_{T_1}(u) &= u^3, \\ t_{T_2}(u) &= \frac{1}{2}(u^3 + u). \end{aligned}$$

For $n = 4$ we have 4 Pólya trees shown in Figure 39. Their automorphism groups are given by $\text{Aut}(T_1) = \text{Aut}(T_2) = \{\text{id}\}$, $\text{Aut}(T_3) = \{\text{id}, (v_3 v_4)\} \cong S_2$, and

$$\text{Aut}(T_4) = \{\text{id}, (v_2 v_3), (v_3 v_4), (v_2 v_4), (v_2 v_3 v_4), (v_2 v_4 v_3)\} \cong S_3.$$

This gives

$$\begin{aligned} t_{T_1}(u) &= u^4, \\ t_{T_2}(u) &= u^4, \\ t_{T_3}(u) &= \frac{1}{2}(u^4 + u^2), \\ t_{T_4}(u) &= \frac{1}{6}(u^4 + 3u^2 + 2u). \end{aligned}$$

This enables us to give a probabilistic interpretation of the composition scheme (146). For a given tree the weight of u^k is the probability that the underlying C -tree is of size k . In particular, T_1 and T_2 do not have D -forests. The tree T_3 consists of a C -tree with 4 or with 2 nodes, each case with probability $1/2$. In the second case, as there is only one possibility for the D -forest, it consists of the pair of single nodes which are the leaves. Finally, the tree T_4 has either 4 C -tree nodes with probability $1/6$, 2 with probability $1/2$, or only one with probability $1/3$. These decompositions are shown in Figure 37.

In the same way as we got the composition scheme in (146), we can rewrite $T_c(z, u)$ from (149) into $T_c(z, u) = C(uzD(z))$. The expected

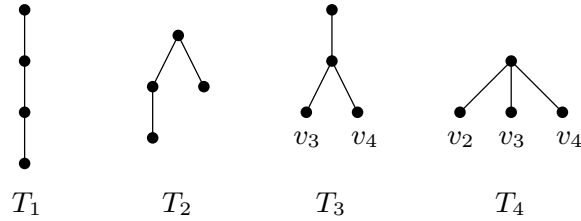

Figure 39: All Pólya trees of size 4.

total weight of all C-trees contained in all Pólya trees of size n is the n -th coefficient of $T_c(z)$, which is

$$T_c(z) := \left. \frac{\partial}{\partial u} T_c(z, u) \right|_{u=1} = \frac{T(z)}{1 - T(z)} \tag{154}$$

$$= z + 2z^2 + 5z^3 + 13z^4 + 35z^5 + 95z^6 + 262z^7 + 727z^8 + \dots$$

Let us explain why these numbers are integers, although the coefficients of $t_{c,n}(u)$ are in general not. We will show an even stronger result. Let T be a tree and $\mathcal{P}(T)$ be the set of all trees with one single pointed (or colored) node which can be generated from T .

Lemma 7.4.3. *For all $T \in \mathcal{T}$ we have $t'_T(1) = |\mathcal{P}(T)|$.*

Proof. From (153) we get that $t'_T(1) = \sum_{\sigma \in \text{Aut}(T)} \frac{\sigma_1}{|\text{Aut}(T)|}$ is the expected number of fixed points in a uniformly at random chosen automorphism of T . The associated random variable C_T is defined in (150). We will prove $\mathbb{E}(C_T) = |\mathcal{P}(T)|$ by induction on the size of T .

The most important observation is that only if the root of a subtree is a fixed point, its children can also be fixed points. Obviously, the root of the tree is always a fixed point.

For $|T| = 1$, the claim holds as $\mathbb{E}(C_T) = 1$ and there is just one tree with a single node and a marker on it. For larger T consider the construction of Pólya trees. A Pólya tree consists of a root T_0 and its children, which are a multiset of smaller trees. Thus, the set of children is of the form

$$\{T_{1,1}, \dots, T_{1,k_1}, T_{2,1}, \dots, T_{2,k_2}, \dots, T_{r,1}, \dots, T_{r,k_r}\}, \quad \text{with } T_{i,j} \in \mathcal{T},$$

and where trees with the same first index are isomorphic. On the level of children, the possible behaviors of automorphisms are permutations within the same class of trees. In other words, an automorphism may interchange the trees $T_{1,1}, \dots, T_{1,k_1}$ in $k_1!$ many ways, etc. Here the main observation comes into play: only subtrees of which the root is a fixed point might also have other fixed points. Thus, the expected number of fixed points is given by the expected number of fixed points in a random permutation of S_{k_i} times the expected number of fixed points in T_{k_i} . By linearity of expectation we get

$$\mathbb{E}(C_T) = \mathbb{E}(C_{T_0}) + \sum_{i=0}^r \underbrace{\mathbb{E}(\# \text{ fixed points in } S_{k_i})}_{=1} \mathbb{E}(C_{T_i}),$$

where $\mathbb{E}(C_{T_i}) = \mathbb{E}(C_{T_{i,j}})$ for all $1 \leq j \leq k_i$ and $\mathbb{E}(C_{T_0}) = 1$ because the root is a fixed point of any automorphism. Since the expected number of fixed points for each permutation is 1, we get on average 1 representative for each class of trees. This is exactly the operation of labeling one tree among each equivalence class. Finally, by induction the claim holds. \square

This completes the proof of Theorem 7.2.2. \square

As an immediate consequence of Lemma 7.4.3, $t'_{c,n}(1)$ counts the number of Pólya trees with n nodes and a single labeled node (see OEIS A000107). This also explains the construction of non-empty sequences of trees in (154): Following the connection of [37, pp. 61–62] one can draw a path from the root to each labeled node. The nodes on that path are the roots of a sequence of Pólya trees.

Remark 23. Note that Lemma 7.4.3 also implies that the total number of fixed points in all automorphisms of a tree is a multiple of the number of automorphisms.

Remark 24. Lemma 7.4.3 can also be proved by considering cycle-pointed Pólya trees; see [42, Section 3.2] for a full description. Let (T, c) be a cycle-pointed structure considered up to symmetry where T is a Pólya tree and c is a cycle of an automorphism $\sigma \in \text{Aut}(T)$. Then, the number of such cycle-pointed structures (T, c) where c has length 1 is exactly the number $t'_T(1)$.

Let us analyze the D -forests in T_n more carefully. We want to count the number of D -forests that have size m in a random Pólya tree T_n . Therefore, we label such D -forests with an additional parameter u in (146). From the bivariate generating function (151) we can recover the probability $\mathbb{P}[|F_n(v)| = m]$ to generate a D -forest of size m in the Boltzmann sampler from [151].

Proof of Theorem 7.2.3

The first result is a direct consequence of (146), where only vertices with weighted D -forests of size m are marked. For the second result we differentiate both sides of (151) and get

$$T_u^{[m]}(z, 1) = \frac{T(z)}{1 - T(z)} \frac{d_m z^m}{D(z)} = T_c(z) \frac{d_m z^m}{D(z)}.$$

Then, the sought probability is given by

$$\mathbb{P}[|F_n(v)| = m] = \frac{[z^n] T_u^{[m]}(z, 1)}{[z^n] T_c(z)} = \frac{d_m \rho^m}{D(\rho)} \left(1 + \mathcal{O}(n^{-1})\right).$$

For the last equality we used the fact that $D(z)$ is analytic in a neighborhood of $z = \rho$.

Let $P_n(u)$ be the probability generating function for the size of a weighted D -forest $F_n(v)$ attached to a vertex v of C_n in a random Pólya tree T_n . From the previous theorem it follows that

$$\begin{aligned} P_n(u) &= \sum_{m \geq 0} \frac{[z^n] T_u^{[m]}(z, 1)}{[z^n] T_c(z)} u^m = \frac{[z^n] T_c(z) \frac{D(zu)}{D(z)}}{[z^n] T_c(z)} \\ &= \frac{D(\rho u)}{D(\rho)} \left(1 + \mathcal{O}(n^{-1}) \right). \end{aligned}$$

This is exactly [151, Eq. (5.2)]. □

Summarizing, we state the asymptotic probabilities that a weighted D -forest $F_n(v)$ in T_n has size equal to or greater than m .

m	$\mathbb{P}[F_n(v) = m] \approx$	$\mathbb{P}[F_n(v) \geq m] \approx$
0	0.9197	1.0000
1	0.0000	0.0803
2	0.0526	0.0803
3	0.0119	0.0277
4	0.0105	0.0161
5	0.0015	0.0060
6	0.0027	0.0041
7	0.0003	0.0014

Table 19: The probability that a weighted D -forest $F_n(v)$ has size equal to or greater than m when $0 \leq m \leq 7$.

7.5 CONCLUSION AND PERSPECTIVES

In this chapter we provide an alternative proof of the maximal size of D -forests in a random Pólya tree. We interpret all weights on D -forests and C -trees in terms of automorphisms associated to a Pólya tree, and we derive the limiting probability that for a random node v the attached D -forest $F_n(v)$ is of a given size.

Our work can be extended to Ω -Pólya trees: For any $\Omega \subseteq \mathbb{N}_0 = \{0, 1, \dots\}$ such that $0 \in \Omega$ and $\{0, 1\} \neq \Omega$, an Ω -Pólya tree is a rooted unlabeled tree considered up to symmetry and with outdegree set Ω . When $\Omega = \mathbb{N}_0$, a \mathbb{N}_0 -Pólya tree is a Pólya tree. In view of the connection between Boltzmann samplers and generating functions, it comes as no surprise that the “colored” Boltzmann sampler from

[151] is closely related to a bivariate generating function. But the unified framework in analyzing the (bivariate) generating functions offers stronger results on the limiting distributions of the size of the C -trees and the maximal size of D -forests.

The next step is the study of shape characteristics of D -forests like the expected number of (distinct) trees. The C -tree is the simply generated tree within a Pólya tree and therefore its shape characteristics is well-known – when conditioned on its size. Moreover, D -forests certainly show a different behavior and, though they are fairly small, they still have significant influence on the tree.

8

COMPACTED BINARY TREES

This chapter is based on joint work with Bernhard Gittenberger, Antoine Genitrini and Manuel Kauers.

Most trees contain redundant information in form of repeated occurrences of the same subtree. These trees can be compacted by representing each occurrence only once. The positions of the removed subtrees will be remembered by pointers which point to the common subtree. Such structures are known as *directed acyclic digraphs* or short as *DAGs*. The gain in memory was analyzed in the extended abstract [86], yet the proofs have been omitted and have not been stated later. This gap was closed in [47], where the framework was extended to other DAG structures and analyzed in the context of XML compression.

In contrast to the previous papers which started with a given set of trees of fixed size and computed its compacted size, we want to determine all compacted trees of fixed size. The difficulty lies in the fact that a compacted binary tree of size n could arise from a binary tree of size n but also from a binary tree of size 2^n . Thus, a brute-force approach is hopeless.

Plan of this chapter. Our approach will build on the fundamental properties of the compactification procedure. We will first analyze the properties of this procedure in Section 8.1. These will help us to state a combinatorial and (most importantly) recursive specification of the problem in Section 8.2. This will also lead to our first main result: *a recurrence relation for the number of compacted binary trees*, see Theorem 8.2.1. Unfortunately, we are not able to solve this recurrence.

In Section 8.4, we consider a simplified problem and try to solve the counting problem of *relaxed binary trees*. These trees are in a sense compacted trees where the restriction of uniqueness on the subtrees is dropped. In particular, compacted trees are a subset of relaxed binary trees. With the same methods as used on compacted trees we are able to derive a recurrence relation. However, this recurrence relation is of the same level of difficulty as the one for compacted trees.

Due to this fact, we follow yet a different approach in the remaining part of this work: we will use *exponential generating functions to model our problem*. We want to emphasize at this point that the problem is on unlabeled objects, but their asymptotic growth is of order $n!A^n$ for a specific $A > 0$. Hence, exponential generating functions are the suitable choice. However, operations on exponential generating functions, such as for example the product possess rather a labeled than an unlabeled interpretation. Hence, we first derive a new calculus on

exponential generating functions, modeling operations on compacted trees. These results are presented in Section 8.3.

This strategy will be successful and we get the second main result of our work: *the enumeration of relaxed and compacted binary trees of bounded right-height* in Sections 8.4 and 8.5. The right-height of a tree is the maximal number of right-edges (or right children) on all paths from the root to any leaf. The calculus on exponential generating functions proves suitable to generate iteratively, ordinary differential equations (ODEs) for the respective generating functions. Iteratively means that from the ODE of trees of right-height k one gets the ODE of trees of right-height $k + 1$. The results are given in Theorems 8.4.8 and 8.5.6.

The third main result is the answer to the asymptotic counting problem of the number of relaxed and compacted binary trees of bounded right-height, see Theorems 8.4.23 and 8.5.12. In order to do so, we extract the necessary information directly from the ODEs. Except for a few exceptions it is not possible to find closed forms of the ODEs.

8.1 CREATING A COMPACTED TREE

In [86, Proposition 1] it was shown that for a given tree of size n its compacted form can be computed in expected time $\mathcal{O}(n)$. However, such procedures have been known since the 1970's. Figure 40 gives a procedure which follows a top-down decomposition scheme (i.e. post-order traversal) of labeled binary trees. Every node (or better to say the subtree whose root is the respective node) is associated with a "unique identifier" (*uid*). Two subtrees are equivalent if and only if the uid's are the same.

This procedure is best understood by an example. Many problems in computer science and computer algebra involve redundant information. A strategy to save memory is to store every instance only once and to mark repeated appearances.

Example 8.1.1. Consider the labeled tree necessary to store the arithmetic expression

$$(* (- (* x x) (* y y)) (+ (* x x) (* y y)))$$

which represents $(x^2 - y^2)(x^2 + y^2)$. The result of the "Table" from the UID procedure is

$$\begin{array}{llll} ((x, 0, 0), 1), & ((*, 1, 1), 3), & ((-, 3, 4), 5), & ((*, 5, 6), 7), \\ ((y, 0, 0), 2), & ((*, 2, 2), 4), & ((+, 3, 4), 6), & \end{array}$$

and the tree in its full and compacted version is shown in Figure 41.

Motivated by this procedure, let us define a DAG-structure which we call a *compacted binary tree*.

```

function UID(T : tree) : integer;

---

global counter : integer, Table : list;
begin
  if T = nil
  then return(0);
  else
    triple := <root(T),UID(left(T)),UID(right(T))>;
    if Found(triple,Table)
    then return(value_found);
    else counter := counter+1;
         Insert pair (triple,counter) in Table;
         return(counter);
    fi
  fi
end

```

Figure 40: The UID procedure from [86, Fig. 2] which computes “unique identifiers” for all subtrees of a given binary tree T . It is assumed that counter is initially set to 0. Table is a global list that maintains associations between triples and already computed UID’s; it is also initially empty. The function $\text{root}(T)$ extracts the label of the root of tree T .

Definition 8.1.2. A compacted binary tree is a DAG computed by the UID procedure from a given binary tree. Every edge leading to a non-distinct subtree is replaced by a new kind of edge, a pointer, to the already existing subtree. Its size is defined by the number of internal nodes.

In the sequel we will only consider binary trees and their compacted forms. For this reason, if we speak of *compacted trees* we mean compacted binary trees. In Figure 42 we see all compacted trees of size 0, 1 and 2.

The subclass of DAGs we are interested in is strongly influenced by properties of trees. In particular, compacted trees are connected and plane. Their out-degree is equal to 2, except for the unique sink (leaf)

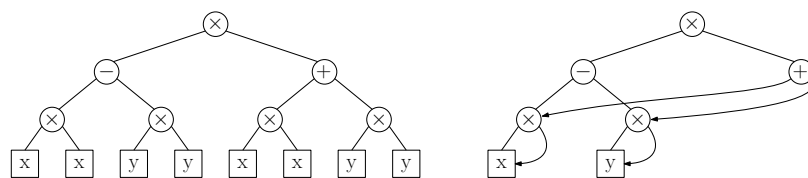

Figure 41: Tree and compacted tree associated with $(* (- (* x x) (* y y)) (+ (* x x) (* y y)))$ computed by the UID procedure from Figure 40.

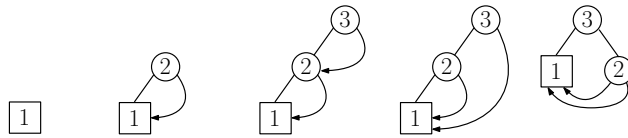

Figure 42: All compacted trees of size $n = 0, 1, 2$. The labels in the nodes are the uids of the corresponding subtrees.

for which it is 0. Furthermore, there is a unique source, which is the root.

These are the properties coming from the tree structure. Next, we treat the specific properties of the UID procedure. The result of the algorithm strongly depends on the chosen traversal. In this case the depth first or post-order traversal is used. (But one could also consider a different one.) There are two important observations. First of all, the post-order traversal has an important consequence on the pointers:

Pointers only point to previously discovered trees.

In other words, the ordering imposed by the traversal restricts the possible choices of the pointers.

Secondly, every distinct subtree is stored only once. In terms of the corresponding compacted trees this translates into uniqueness of every fringe subtree. A *fringe subtree* or short *subtree* is the tree which corresponds to a node and all its children. We will only consider such subtrees. Due to the previous observation on pointers, such subtrees in compacted trees need NOT be compacted trees themselves as pointers may point to nodes that are not part of this subtree. For this reason we define the concept of *c-subtrees*.

Definition 8.1.3. A *c-subtree* is a subtree of a compacted tree. A *cherry* is a *c-subtree* where both children of the root are pointers.

A cherry is in a sense the “minimal” construction to create a new subtree. It consists of a node and two pointers, which point to already existing *c-subtrees*. An example is given in Figure 42: In the last tree the *c-subtree* with the root node labeled with 2 is a cherry. It is also not a compacted tree of Definition 8.1.2 as the root node has two pointers. The only compacted tree of size 1 is also given in the same Figure.

With this terminology we are able to characterize compacted trees in terms of DAGs. First we look at what happens if we delete all pointers.

Lemma 8.1.4. *Deleting the leaf and all pointers from a compacted tree of size n gives a binary tree of size n .*

Proof. Obviously, by deleting the leaf and the pointers we get an acyclic and undirected graph. It remains to show that this graph is

connected. Assume that there exists a pointer which is the only connection between two parts of the compacted tree. By the UID procedure a pointer corresponds to a multiple occurrence of a subtree. Therefore we get a contradiction, as this subtree must already exist in the tree and is therefore connected with the root via internal edges. \square

Proposition 8.1.5. *A compacted tree of size n is constructed from a binary tree of size n and the following operations:*

1. *add a leaf at the first possible space in post-order traversal.*
2. *add pointers to every node such that all nodes except the leaf have out-degree 2.*
3. *point the pointers to internal nodes which are in post-order traversal before the root node such that the corresponding subtree is unique.*

Proof. On the one hand, a binary tree which is compacted by the UID procedure and conditioned to have size n obviously has these properties.

On the other hand, a tree with these properties is a compacted tree, as by decompacting and compacting it, one arrives at the same structure. \square

The last result tells us that cherries are responsible for the uniqueness property of compacted trees. Note that a cherry violating the last expression leads to a different compacted tree.

A different explanation why cherries are the crucial objects for the uniqueness comes from the property that the compactification procedure generates an increasing set of elements. By that we mean that the next element is constructed by a new internal node and previous already constructed elements. In particular, the first element is always a leaf, and the second one is always an internal node with two leaves as children (a “classical cherry” in a sense). Then, as a third element one has an element with a new internal node and a cherry as its left or right child, or on both sides. Let us then consider the possibilities to create an existing subtree. There are two cases:

1. **Cherry:** Choose an existing subtree and let the two pointers of the subtree point to the children of the subtree. This is possible as the children are also subtrees which have already been used.
2. **Non-cherry:** In this case at least one edge is not a pointer. But then we may assume (induction) that the subtree of the corresponding child is unique. Hence, this node cannot construct an already existing subtree.

This idea will be picked up in the next section and used to derive a recurrence relation on the number of compacted trees of size n .

8.2 A RECURRENCE RELATION

Let c_n be the number of compacted binary trees of size n . In Figure 42 we see all compacted trees of size 0, 1 and 2. It is easily checked that the first few terms of the sequence are given by

$$(c_n)_{n \geq 0} = (1, 3, 15, 111, 1119, 14487, 230943, 4395855, \dots).$$

Note that this sequence is not found in Sloane's OEIS. As a first step we will derive a recursion representing this sequence.

Let $c_{n,p}$ be the sequence representing the number of c -subtrees of size n where p c -subtrees with at least one internal node have already been discovered in higher branches. We can think of the already compacted subtrees as a pool of trees where our pointers can point to additionally. Note that the leaf is always part of this pool but not counted, and all subtrees in the pool must be constructed out of elements in the pool. In this sense the pool is closed in itself.

We define the size of the pool as the number of distinct subtrees with at least one internal node, or equivalently with more than one level. Thus, the pool in $c_{n,p}$ has size p and consists of $p + 1$ distinct c -subtrees. This artificially looking convention will simplify the later analysis.

Theorem 8.2.1. *Let $n, p \in \mathbb{N}$, then*

$$c_{n+1,p} = \sum_{i=0}^n c_{i,p} c_{n-i,p+i}, \quad \text{for } n \geq 1, \quad (155)$$

$$c_{0,p} = p + 1, \quad (156)$$

$$c_{1,p} = p^2 + p + 1. \quad (157)$$

Proof. An element counted by $c_{n,p}$ consists of n internal nodes and one leaf. The remaining n edges of the compacted binary tree are given by pointers. These must be chosen in such a way that no subtree is generated twice. Additionally, they may point either to one c -subtree of the pool or a c -subtree below the current node. The second condition is due to the post-order traversal of the tree of the UID procedure.

Now we can give a recursive decomposition of such trees. Let t be a c -subtree with $n + 1$ nodes and a pool of size p . The root of t has a left and a right subtree attached with i and $n - i$, $i = 0, \dots, n$ internal nodes, respectively. Note that every internal node also represents a c -subtree. In the left child the pool remains the same as for its parent. However, in the right child the pointers may additionally point to c -subtrees of its left sibling, hence, the pool increases by the size of its left sibling. These considerations directly give (155).

Next, let us consider the initial conditions (156) and (157). First, c -subtrees without internal nodes can be interpreted as pointers. These may point to any element of the pool, hence $c_{0,p} = p + 1$.

Second, the c -subtrees with 1 internal node are cherries, whose both children are not internal nodes. Hence, they consist either of two pointers or of a leaf and a pointer. As the pool always contains a leaf, it is sufficient to consider the first case. Then these two pointers have $p + 1$ possibilities each to point at. Among these $(p + 1)^2$ cases are p which must be excluded as they are the ones already found in the pool. Note that these can be recreated by letting the pointers point to the same children as the ones found in the pool. Hence, we get

$$c_{1,p} = (p + 1)^2 - p = p^2 + p + 1. \quad \square$$

Lemma 8.2.2. *The number of compacted binary trees of size n satisfies the following bounds:*

$$n! \leq c_n \leq \frac{1}{n + 1} \binom{2n}{n} \cdot n!.$$

Proof. We start with a compacted tree with n internal nodes and construct a binary tree with n internal nodes and labeled leaves. We proceed in the following way: Traverse the tree in post-order and give the first leaf the label 1. Then label the internal nodes in the order you encounter them. An example of such a tree can be found on the left-hand side of Figure 43. Now replace every pointer by a leaf and give the leaf the label of the node the pointer was pointing at. The tree that is obtained in this way by transforming the tree on the left-hand side of Figure 43, is shown on the right-hand side.

We know that pointers in a compacted tree may only point to the left, which means that the labels of the leaves in the transformed tree always must be smaller than their parent's label. In other words, the leaves of a node labeled i may only be labeled by $1, 2, \dots, i - 1$ (possibly not all such labelings can really occur).

We still need to show that the total number of possible labelings is bounded by $n!$. This can be seen as follows: To every leaf l of the tree (except for the left-most one) we associate a second label in a unique way. This label is denoted by j_l and is written in red next to every leaf (except for the left-most one) in the tree on the right-hand side of Figure 43. In order to determine this label we again traverse the tree in post-order. When we have reached a leaf l , we move along the path towards the root. As soon as we encounter a "free" node, i.e., a node with a label that has not yet been used for any of the leaves, we stop and choose this label to be j_l . Then we continue with the next leaf according to post-order traversal. We can now observe the following: Since the labels increase when we move towards the root, j_l is at least as big as the label of l 's parent. Thus, the number of possibilities for labeling l is bounded by $j_l - 1$. In total every label between 2 and $n + 1$ occurs in one of the internal nodes of the tree, implying that the total number of possible labelings of the leaves is bounded by $n!$. \square



Figure 43: Construction in the proof of Lemma 8.2.2 for $n = 4$.

The last result implies that the asymptotic growth of compacted trees is bounded and of order $\mathcal{O}(n!4^n n^{-1/2})$, but also bounded from below by $n!$. Thus, an ordinary generating function for c_n would have zero radius of convergence. Hence, we will need to use exponential generating functions in order to have a non-zero radius. This idea will be used in the next sections. First, we state a simplified problem, which also proves very difficult to solve, but is not as technical.

A relaxed problem

A *relaxed compacted binary tree* (short *relaxed binary tree*, or just *relaxed tree*) of size n is a directed acyclic graph consisting of a binary tree with n internal nodes, one leaf, and n pointers. It is constructed from a binary tree of size n , where the first leaf in a depth-first traversal is kept and all other leaves are replaced by pointers. These point to any node that has already been visited in a depth-first traversal.

Compacted trees are relaxed trees with the restriction that all subtrees in the corresponding tree are unique. For relaxed trees this condition does not hold anymore.

Let r_n be the number of relaxed trees of size n . The first few terms of the sequence are given by

$$(r_n)_{n \geq 0} = (1, 1, 3, 16, 127, 1363, 18628, 311250, 6173791, \dots).$$

This sequence is given by the sequence A082161 in the OEIS. It counts the number of deterministic completely defined initially connected acyclic automata with 2 inputs and n transient unlabeled states and a unique absorbing state, see [137]. The bijection of these trees to our trees is trivial, by traversing relaxed trees from the root to the leaf. We directly get a recurrence relation for these numbers

Corollary 8.2.3. *Let $n, p \in \mathbb{N}$, then*

$$r_{n+1,p} = \sum_{i=0}^n r_{i,p} r_{n-i,p+i}, \quad \text{for } n \geq 1,$$

$$r_{0,p} = p + 1.$$

Proof. This is a direct consequence of Theorem 8.2.1 and the fact that the uniqueness restriction given by condition (157) was dropped. \square

Note that the nature of the recurrence relation did not change compared to the one of the compacted case. Unfortunately, we were not able to find an explicit solution, or to continue from here. A more promising approach is the one of generating functions introduced in the next section.

8.3 OPERATIONS ON TREES

The coefficients are growing like $n!A^n$, (compare Lemma 8.2.2, which also holds in the relaxed case) we need to use exponential generating functions in order to get a non-zero radius of convergence. But then there arises a problem in the construction: exponential generating functions are designed for labeled objects, but ours are unlabeled. Thus, we first investigate how the nature of exponential generating functions reflects the construction of such trees.

The use of non-standard generating functions in the enumeration of DAGs is not new. Robinson [159] introduced the so-called “special generating function”

$$A(t) = \sum_{n \geq 0} a_n 2^{-\binom{n}{2}} \frac{t^n}{n!},$$

to obtain nice expressions of such generating functions for labeled DAGs. This generating function is not applicable in our context, but exponential generating functions are.

For this purpose we restrict ourselves to a subclass: compacted trees of bounded right-height.

Definition 8.3.1. (*Spine and right-height*) For any compacted tree define the spine as the tree arising from the compacted tree by deleting all pointers and the leaf. The right-height of a compacted tree is defined by the maximal number of right-edges on any path from the root to another node in the spine, compare Figure 44. The level of a node is the number of right-edges on the path from the root to this node.

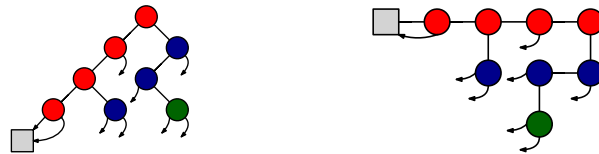

Figure 44: A binary tree with right-height 2. Nodes of level 0 are colored in red, nodes of level 1 in blue, and the node of level 3 in green. It proves convenient to rotate the trees by 45 degrees.

We are going to derive the exponential generating functions for relaxed trees of bounded right-height. In this context we introduce the following notation: Let \mathcal{R} be a combinatorial class. Its exponential generating function is given by $R(z) = \sum_{n \geq 0} r_n \frac{z^n}{n!}$ where r_n denotes the number of elements in \mathcal{R} of size n .

Lemma 8.3.2. (New root) Let \mathcal{R} be the combinatorial class of relaxed trees, and let \mathcal{S} be the combinatorial class whose elements consist of a new root node, an element of \mathcal{R} as its left-child, and a pointer as its right-child. Then,

$$S(z) = zR(z).$$

Proof. Consider a tree of \mathcal{R} of size n . Adding a new root node with the considered tree as its left child creates a tree of size $n + 1$. The new pointer has $n + 1$ possibilities, in particular it may point to one of the n internal nodes or the leaf. On the level of generating functions this implies

$$S(z) = \sum_{n \geq 0} (n + 1)r_n \frac{z^{n+1}}{(n + 1)!} = zR(z). \quad \square$$

By the term “adding a new root” we will from now on always refer to the case described in Lemma 8.3.2. In other words, the new root node will be such that the old tree is the left-child and a pointer is the right-child.

With the help of this lemma we are able to find the generating function of relaxed trees of right-height equal to 0. Let \mathcal{R}_0 be the respective combinatorial class, and $R_0(z) = \sum_{n \geq 0} r_{0,n} \frac{z^n}{n!}$ be the associated generating function.

Corollary 8.3.3. The generating function of relaxed trees of right-height equal to 0 is

$$R_0(z) = \frac{1}{1-z}, \quad \text{and} \quad r_{0,n} = n!.$$

Proof. Such a tree is either just a leaf of size 0 or it is constructed from an element of \mathcal{R}_0 by appending a new root node. Obviously, this construction does not increase the right-height, and it constructs all such trees. On the level of generating functions this translates into

$$R_0(z) = 1 + zR_0(z).$$

Solving the equation and extracting coefficients gives the result. \square

Note that the previous result does not need an exponential generating function based calculus, as the reasoning in the previous proof directly implies a recursion $r_{n+1} = (n + 1)r_n$ with $r_0 = 1$, compare Figure 45. However, exponential generating functions are build in such a way that they model exactly this situation which will prove useful in more complicated examples.

We proceed now with other operations on combinatorial classes and generating functions. The next two might seem “strange” at first glance, as they do not produce relaxed trees. However, they are the atomic operations to construct other ones.

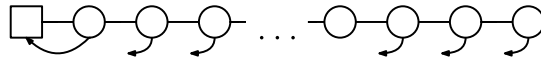

Figure 45: The number of relaxed trees of size n of right-height at most 0 is equal to $n!$.

Lemma 8.3.4 (Adding/deleting the root while ignoring pointers). *Let \mathcal{R} be a class of relaxed trees. Let \mathcal{I} be the class obtained from \mathcal{R} by adding a new root node without pointer, and let \mathcal{D} be the class obtained from \mathcal{R} by deleting the root node but preserving its pointer and deleting elements of size 0. Then,*

$$I(z) = \int R(z) dz,$$

$$D(z) = \frac{d}{dz}R(z).$$

Proof. Adding a new root node increases the size by one, whereas deleting it decreases it by one. Hence, elements of \mathcal{R} of size n are in bijection with elements of \mathcal{I} of size $n + 1$ as well as with elements of \mathcal{D} of size $n - 1$, compare Figure 46. Therefore, we get

$$I(z) = \sum_{n \geq 0} r_n \frac{z^{n+1}}{(n+1)!} = \int R(z) dz,$$

$$D(z) = \sum_{n \geq 1} r_n \frac{z^{n-1}}{(n-1)!} = \frac{d}{dz}R(z). \quad \square$$

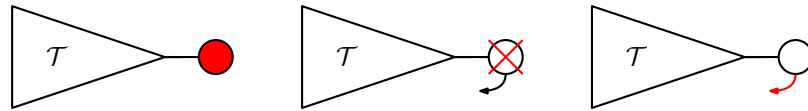

Figure 46: Adding a new root node without pointer, deleting a root node while preserving its (possible) pointer, and adding a new pointer to the existing root node.

These can then be used to derive the following to operations:

Proposition 8.3.5 (Sequences and pointers). *The generating function $S(z)$ obtained by appending an arbitrary (possibly empty but finite) sequence of root nodes to a class \mathcal{R} is given by*

$$S(z) = \frac{1}{1-z}R(z).$$

The generating function $P(z)$ obtained by adding a new, additional pointer to all root nodes of a class \mathcal{R} is given by

$$P(z) = z \frac{d}{dz}R(z) + r_0.$$

Proof. This is a direct consequence of the Lemmas 8.3.2 and 8.3.4, compare Figures 46 and 47. □

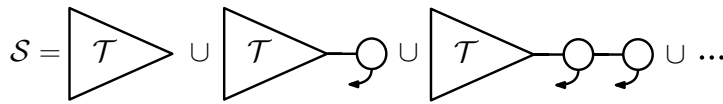

Figure 47: Appending a finite, possibly empty sequence to the root node.

In the sequel it will prove convenient to work with operators on generating functions. For this purpose we will use the same letters for the operators as were used for the combinatorial classes (or generating functions) in the previous results.

Now we have all operations needed to continue our investigation of trees with bounded right-height. In the next sections we show how the derived calculus can be used to derive differential equation of relaxed and compacted trees of bounded right-height.

8.4 RELAXED BINARY TREES

We will now show how to use the methods from Section 8.3 to derive ordinary differential equations for the exponential generating functions of relaxed trees of bounded right-height. In this context we introduce the following notation: Let \mathcal{R} be the combinatorial class of relaxed trees. Its exponential generating function is given by $R(z) = \sum_{n \geq 0} r_n \frac{z^n}{n!}$ where r_n denotes the number of elements in \mathcal{R} of size n . We denote the class of relaxed trees of right-height at most k by \mathcal{R}_k and its corresponding exponential generating function by $R_k(z) = \sum_{n \geq 0} r_{k,n} \frac{z^n}{n!}$.

We have derived $R_0(z)$ in Corollary 8.3.3 as

$$R_0(z) = \frac{1}{1-z} = \sum_{n \geq 0} n! \frac{z^n}{n!}.$$

Let us now consider relaxed trees of right-height at most 1.

Relaxed trees of right-height at most 1

Let \mathcal{R}_1 be the combinatorial class of relaxed trees with right-height at most 1, compare Figure 48. The corresponding generating function is given by $R_1(z) = \sum_{n \geq 0} r_{1,n} \frac{z^n}{n!}$.

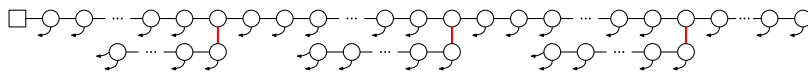

Figure 48: A relaxed tree from \mathcal{R}_1 , i.e. with right-height at most 1.

We will break the problem into smaller parts by decomposing $R_1(z)$ into

$$R_1(z) = \sum_{\ell \geq 0} R_{1,\ell}(z), \tag{158}$$

where $R_{1,\ell}(z)$ is the exponential generating function of relaxed binary trees with exactly ℓ right-subtrees, i.e. ℓ right-edges in the spine going from level 0 to level 1. Obviously, we have $R_{1,0}(z) = R_0(z) = \frac{1}{1-z}$. In order to get $R_{1,1}(z)$ we apply the previously derived constructions. An illustration of such a tree is shown in Figure 49.

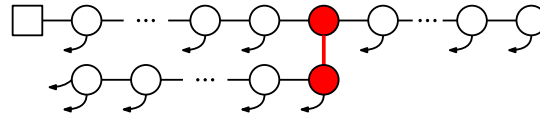

Figure 49: A relaxed tree with exactly one right-edge in the spine.

Proposition 8.4.1. *The generating function of relaxed trees with exactly one right-edge in the spine is given by*

$$R_{1,1}(z) = \frac{1}{1-z} \int \frac{1}{1-z} z (zR_{1,0}(z))' dz.$$

Proof. The idea is to decompose the structure of $R_{1,1}(z)$ into smaller parts, which are in bijection to constructible classes.

1. On level 0, after the unique right-edge there is a sequence of nodes, whose pointers may only point to elements of itself. This is an element of \mathcal{R}_0 and thus counted by $R_0(z)$. Hence, we can delete this sequence, see Figure 50.

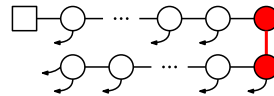

Figure 50: Step 1: We delete the first sequence of nodes on level 0.

2. Next, we see that the elements on level 1 form a sequence with a cherry (2 pointers at one node) as its last element. Its pointers may point to nodes of elements further down and to elements in the previously discussed sequence of 1. By moving the $R_0(z)$ instance on level 0 to the end of this sequence on level 1 we get a sequence, with one special node inside which has two pointers, compare Figure 51. In terms of generating functions we get

$$\hat{R}_{1,0}(z) := \frac{1}{1-z} \underbrace{z (zR_{1,0}(z))'}_{\text{add root with 2 pointers}}. \tag{159}$$

Note that due to the cherry every element has at least one internal node.

3. Furthermore, notice that the node on level 0 of the right-edge has no pointers. However, elements of the sequence before may point to it. Therefore, we reinsert the node deleted in level 0 by adding it as a new root. The constructed object bijectively corresponds to $R_{1,1}(z)$ elements without an initial sequence.

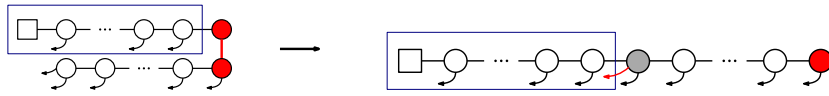

Figure 51: Step 2: Nodes of level 1 can only point to nodes on level 0 (left); moving these nodes to level 1 and deleting the level 0 node gives $\hat{R}_{1,0}(z)$ (right).

4. Finally, adding this initial sequence is achieved by a factor $\frac{1}{1-z}$, compare Proposition 8.3.5. See Figure 52 for the final class of elements.

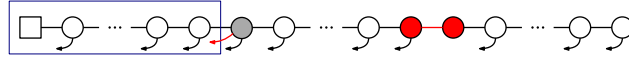

Figure 52: Step 4: The final sequence-like object bijectively corresponding to $R_{1,1}(z)$.

By the previously derived operations from Section 8.3 we get the claimed relation on generating functions. \square

The main idea of the previous proof was to cut and glue the $R_{1,1}(z)$ instance in such a way that a sequence-like object appears which is in bijection with the previous one. This new object has the advantage of being constructible by the operations introduced in Section 8.3.

Of course one can easily compute $R_{1,1}(z)$ explicitly. Yet, it is better to generalize this representation to $R_{1,\ell}(z)$.

Corollary 8.4.2. *The generating function of relaxed trees with exactly ℓ right-edges in the spine from level 0 to level 1 is given by*

$$R_{1,\ell}(z) = \frac{1}{1-z} \int \frac{1}{1-z} z (zR_{1,\ell-1}(z))' dz, \quad \ell > 1,$$

$$R_{1,0}(z) = R_0(z) = \frac{1}{1-z}.$$

Proof. By cutting at the first right-edge from level 0 to level 1 we observe a decomposition into an initial sequence, a right-edge from level 0 to level 1 with 2 nodes, a sequence on level 1 and an instance counted by $R_{1,\ell-1}(z)$. Compare with Figure 53. Thus, we may reuse the construction from Proposition 8.4.1 by exchanging the initial value $R_{1,0}(z)$ with $R_{1,\ell-1}(z)$. \square

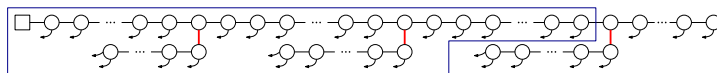

Figure 53: The decomposition of $R_{1,\ell}(z)$ into an initial sequence, the first right-edge, a sequence on level 1, and an instance of $R_{1,\ell-1}(z)$.

Finally, we are able to combine the previous results to derive the generating function of $R_1(z)$. We will need the notion of *double factorials* $n!! := \prod_{k=0}^{\lfloor \frac{n-1}{2} \rfloor} (n - 2k)$ for $n \in \mathbb{N}$.

Theorem 8.4.3. *The exponential generating function of relaxed trees of right-height at most 1 is D-finite and satisfies*

$$(1 - 2z)R_1'(z) - R_1(z) = 0, \quad R_1(0) = 1.$$

The closed form and the coefficients are given by

$$R_1(z) = \frac{1}{\sqrt{1-2z}}, \quad r_{1,n} = (2n - 1)!!.$$

Proof. We start with the result from Corollary 8.4.2. But instead of the integral representation, we use the following differential equation valid for $\ell \geq 1$:

$$(1 - z) ((1 - z)R_{1,\ell}(z))' = z (zR_{1,\ell-1}(z))'.$$

Remembering the initial decomposition in (158) we sum over all $\ell \geq 1$ and get

$$(1 - z) ((1 - z) (R_1(z) - R_{1,0}(z)))' = z (zR_1(z))'.$$

Rearranging this equation and replacing $R_{1,0}(z) = R_0(z)$ we get

$$(1 - 2z)R_1'(z) - R_1(z) - (1 - z) ((1 - z)R_0(z))' = 0. \tag{160}$$

Now, $R_0(z) = \frac{1}{1-z}$, hence the differential equation simplifies to

$$(1 - 2z)R_1'(z) - R_1(z) = 0.$$

Solving this equation by separation of variables yields the closed-form expression. Finally, extracting coefficients is easy while remembering $\frac{1}{\sqrt{1-4z}} = \sum_{n \geq 0} \binom{2n}{n} z^n$. \square

Remark 25. The number of increasing trees of size n is equal to $(2n - 3)!!$. Its generating function is given by $1 - \sqrt{1 - 2z}$. So far we were not able to find a bijection between these or any other objects counted by the sequence OEIS A001147. Note that all mentioned objects are labeled objects.

Relaxed trees of right-height at most 2

Let \mathcal{R}_2 be the combinatorial class of relaxed trees with right-height at most 2, compare Figure 54. The corresponding generating function is given by $R_2(z) = \sum_{n \geq 0} r_{2,n} \frac{z^n}{n!}$.

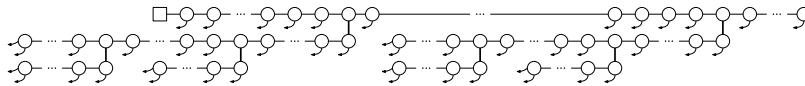

Figure 54: A relaxed tree from R_2 , i.e. with right-height at most 2.

As before, we will break the problem into smaller parts by decomposing $R_2(z)$ into

$$R_2(z) = \sum_{\ell \geq 0} R_{2,\ell}(z), \tag{161}$$

where $R_{2,\ell}(z)$ is the exponential generating function of relaxed trees of right-height at most 2 with exactly ℓ right-subtrees on level 0, i.e. ℓ right-edges in the spine going from level 0 to level 1. Obviously, we have $R_{2,0}(z) = R_0(z) = \frac{1}{1-z}$.

Proposition 8.4.4. *The exponential generating function of relaxed trees of right-height at most 2 with exactly one right-edge from level 0 to level 1 in the spine satisfies*

$$(1-2z) \left((1-z)R_{2,1}(z) \right)'' - \left((1-z)R_{2,1}(z) \right)' - \left(z(zR_{2,0}(z))' \right)' = 0. \tag{162}$$

Proof. The main idea is to decompose the structure of $R_{2,1}(z)$ again into 4 parts (compare Figure 55): an initial sequence, the first right-edge from level 0 to level 1, the sequence on level 0 after this right edge, and an instance of $R_1(z)$ starting on level 1 after this right-edge. Then we use the same transformation idea as in the proof of Proposition 8.4.1. We take the sequence on level 0 after the right-edge and move it to the end of the $R_1(z)$ instance. Note that this is legitimate concerning the pointers. But it generates a node with 2 pointers within a sequence of $R_1(z)$. With respect to $R_1(z)$ this change happens on its top level to the very left.

We can now neglect the initial sequence and the level 0 node of the right-edge, as they can be created again by known operations. Let us call the object obtained by deleting these two parts $F(z)$. By Lemma 8.3.4 and Proposition 8.3.5 we get

$$F(z) = \left((1-z)R_{2,1}(z) \right)'.$$

Note that $F(z)$ is a structure with right-height at most 1. It is nearly an instance of $R_1(z)$. There are only 2 differences:

First, it has a special construction after its last right-edge. With respect to the differential equation (160) defining the class $R_1(z)$, this change affects the initial condition $R_0(z)$. Thus, we can reuse this specification, by replacing the initial condition. It is given by the expression $\frac{1}{1-z} (zR_{2,0}(z))'$, because a (possibly empty) sequence, is followed by a node with a double pointer, and another sequence (compare Fig-

ure 51). Hence, this restriction is satisfied by a function $G(z)$ given by

$$(1 - 2z)G'(z) - G(z) - (1 - z)((1 - z)G_0(z))' = 0, \quad \text{with}$$

$$G_0(z) = \frac{1}{1 - z}(zR_{2,0}(z))'.$$

Second, due to the unique right-edge from level 0 to level 1, every object in $F(z)$ has at least one node. The elements in $G(z)$ which do not satisfy this condition are leaves, and are a part of $G_0(z)$. As $G_0(z)$ is a sequence construction, we can express the generating function of elements in the class $G_0(z)$ which are not leaves by $zG_0(z)$. This then gives

$$F(z) = G(z) - (1 - z)G_0(z).$$

This gives

$$G(z) = ((1 - z)R_{2,1}(z))' + (zR_{2,0}(z))'. \tag{163}$$

Putting everything together some tedious calculations show the claimed differential equation (162). \square

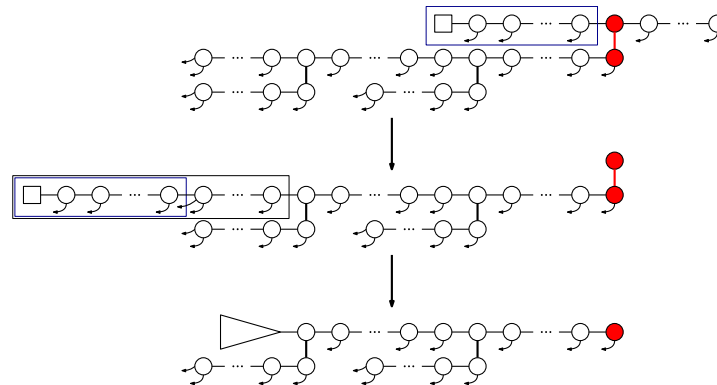

Figure 55: Transforming $R_{2,1}$ into an instance of R_1 .

Remark 26. We want to comment on the last reasoning in the previous proof. It might seem complicated to delete the leaf by subtracting $G_0(z)$ and adding the shifted version $zG_0(z)$. Another solution would obviously be to subtract only the occurrence of a leaf, i.e. set $F(z) = G(z) - 1$. This is of course legitimate, however it leads to an inhomogeneous differential equation. We will see that it is crucial to have a homogeneous equation, because we want to sum over infinitely many of them.

As in the $R_{1,\ell}(z)$ case, we get $R_{2,\ell}(z)$ for $\ell \geq 2$ by a recursive application of the previous arguments.

Corollary 8.4.5. *The generating function of relaxed trees with right-height at most 2, and exactly $\ell > 1$ right-edges in the spine from level 0 to level 1 is given by*

$$(1 - 2z) ((1 - z)R_{2,\ell}(z))'' - ((1 - z)R_{2,\ell}(z))' - (z(zR_{2,\ell-1}(z)))' = 0,$$

with the initial value

$$R_{1,0}(z) = R_0(z) = \frac{1}{1 - z}.$$

Proof. By cutting at the first right-edge from level 0 to level 1 we observe a decomposition into an initial sequence, a right-edge from level 0 to level 1 with 2 nodes, a sequence on level 1 and an instance counted by $R_{2,\ell-1}(z)$. Thus, we may reuse the construction from Proposition 8.4.4 by exchanging the initial value $R_{2,0}(z)$ with $R_{2,\ell-1}(z)$. \square

Note that for the final result it is crucial that we found homogeneous differential equations.

Theorem 8.4.6. *The exponential generating function of relaxed trees of right-height at most 2 is D-finite and satisfies*

$$(z^2 - 3z + 1)R_2''(z) + (2z - 3)R_2'(z) = 0, \quad R_2(0) = 1, \quad R_2'(0) = 1.$$

A closed form and the coefficients are given by

$$R_2(z) = -\frac{2}{\sqrt{5}} \operatorname{artanh} \left(\frac{2z - 3}{\sqrt{5}} \right) - \frac{1}{\sqrt{5}} \left(\log \left(\frac{7 + 3\sqrt{5}}{2} \right) - \pi i \right),$$

$$r_{2,n} = \frac{(n - 1)!}{\sqrt{5}} \left(\left(\frac{3 + \sqrt{5}}{2} \right)^n - \left(\frac{3 - \sqrt{5}}{2} \right)^n \right).$$

Proof. Again, let us take the result of Corollary 8.4.5 and sum over all $\ell \geq 1$, while remembering the decomposition (161). By linearity this gives

$$(1 - 2z) ((1 - z)(R_2(z) - R_{2,0}(z)))'' - ((1 - z)(R_2(z) - R_{2,0}(z)))' - (z(zR_2(z)))' = 0. \tag{164}$$

A simplification gives

$$(z^2 - 3z + 1)R_2''(z) + (2z - 3)(R_2'(z) - R_{2,0}'(z)) - (1 - 2z)((1 - z)R_{2,0}(z))'' + ((1 - z)R_{2,0}(z))' = 0.$$

Inserting the initial value $R_{2,0}(z) = \frac{1}{1-z}$ we get the D-finite expression. The correctness of the closed form can then be easily checked with e.g. a computer algebra system.

In order to deduce its coefficients we observe that the differential equation can be simplified further by an integration with respect to z . Thus, it is equivalent to

$$(z^2 + 3z + 1)R_2'(z) = 1, \quad R_2(0) = 1,$$

as $R_2'(0) = 1$. Next, observe that as we are dealing with exponential generating functions, the derivative is just a shift on the level of coefficients. In other words, $[z^n]R_2(z) = [z^{n-1}]R_2'(z)$. Therefore, a partial fraction decomposition enables a direct extraction of the coefficients. \square

Relaxed trees of right-height at most k

The approach from the previous section can then be generalized to arbitrary right-height at most k for $k \geq 2$. Let $R_k(z) = \sum_{n \geq 0} r_{k,n} \frac{z^n}{n!}$ be the corresponding generating function. The idea is to use the previous construction, and to derive the differential equation for $R_k(z)$ from the one of $R_{k-1}(z)$.

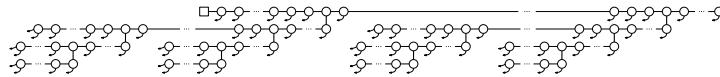

Figure 56: A relaxed tree from R_3 , i.e. with right-height at most 3.

We introduce a family of linear differential operators L_k , $k \geq 1$ which describe all differential equations constructed for $R_k(z)$. We use the notation $D \cdot F = \frac{d}{dz}F(z)$ for the differential operator and $1 \cdot F(z) = F(z)$ for the identity operator.

Theorem 8.4.7 (Differential operators). *Let $(L_k)_{k \geq 0}$ be a family of differential operators given by*

$$\begin{aligned} L_0 &= (1 - z), \\ L_1 &= (1 - 2z)D - 1, \\ L_k &= L_{k-1} \cdot D - L_{k-2} \cdot D^2 \cdot z, \quad k \geq 2. \end{aligned}$$

Then the exponential generating function $R_k(z)$ for relaxed trees with right-height at most k satisfies

$$L_k \cdot R_k = 0.$$

Proof. We are going to derive two families of operators: The differential operator L_k and an auxiliary operator H_k for the inhomogeneity:

$$L_k \cdot R_k = H_k \cdot R_0.$$

For $k = 1$ this claim holds due to Theorem 8.4.3 and Equation (160). We have that $H_1 \cdot F = (1 - z)((1 - z)F)' = L_0 \cdot ((1 - z)F)'$.

We continue with the case $k = 2$. In (163) we have derived the necessary substitution to get the differential equation of $R_2(z)$ from the one of $R_1(z)$. The idea was to decompose $R_2(z)$ with respect to the number of right-edges from level 0 to level 1, and to get one differential equation for each case. Observe that after summing these equations we arrive at the final expression (164). Here we see the influence of the previous substitution and derive the claim:

$$\begin{aligned} L_2 \cdot F &= L_1 \cdot (((1-z)F)' + (zF)') - H_1 \cdot \left(\frac{1}{1-z} (zF)' \right) \\ &= L_1 \cdot (F') - L_0 \cdot ((zF)''). \end{aligned}$$

Furthermore, also from (164) we see that (terms involving $R_{2,0}(z)$)

$$H_2 \cdot F = L_1 \cdot (((1-z)F)'). \tag{165}$$

Inserting $R_0(z) = \frac{1}{1-z}$ reproves the case $k = 2$.

Finally, for larger k we can recycle the previous arguments for $k = 2$ and apply them recursively. This holds, as we may again cut an instance of $R_k(z)$ at the first right-edge in the spine from level 0 to level 1 and decompose it in the repeatedly shown fashion, compare Figure 55. Then the same reasoning as in Section 8.4 allows us to extract the differential equation of $R_k(z)$ from the one of $R_{k-1}(z)$ by

$$\begin{aligned} L_k \cdot F &= L_{k-1} \cdot (F') - H_{k-1} \cdot \left(\frac{1}{1-z} (zF)' \right), \\ H_k \cdot F &= L_{k-1} \cdot (((1-z)F)'). \end{aligned}$$

Hence, by induction the claim holds. □

Let us apply the last theorem and compute the first few differential equations.

$$\begin{aligned} (1-2z) \frac{d}{dz} R_1(z) - R_1(z) &= 0, \\ (z^2-3z+1) \frac{d^2}{dz^2} R_2(z) + (2z-3) \frac{d}{dz} R_2(z) &= 0, \\ (3z^2-4z+1) \frac{d^3}{dz^3} R_3(z) + (9z-6) \frac{d^2}{dz^2} R_3(z) + 2 \frac{d}{dz} R_3(z) &= 0, \\ -(z^3-6z^2+5z-1) \frac{d^4}{dz^4} R_4(z) - (6z^2-24z+10) \frac{d^3}{dz^3} R_4(z) \\ - (6z-11) \frac{d^2}{dz^2} R_4(z) &= 0. \end{aligned}$$

The initial conditions can be obtained from lower solutions. Note from the construction that the first $k + 1$ coefficients of $R_k(z)$ enumerate all relaxed trees up to size $k + 1$. This is due to the fact that a tree of size $k + 1$ has always right-height at most k .

Next, we take a closer look at these operators.

Theorem 8.4.8 (Properties of L_k). *For any $k \in \mathbb{N}$, let L_k be as in Theorem 8.4.7. Let $\ell_{k,i} \in \mathbb{C}[z]$ be such that*

$$L_k = \ell_{k,k}(z)D^k + \ell_{k,k-1}(z)D^{k-1} + \dots + \ell_{k,0}(z).$$

Then we have

$$\begin{aligned} \ell_{k,0}(z) &= 0, \\ \ell_{k,1}(z) &= \ell_{k-1,0}(z) - 2\ell_{k-2,0}(z), \\ \ell_{k,i}(z) &= \ell_{k-1,i-1}(z) - (i+1)\ell_{k-2,i-1}(z) \\ &\quad - z\ell_{k-2,i-2}(z), \qquad 2 \leq i \leq k-1, \\ \ell_{k,k}(z) &= \ell_{k-1,k-1}(z) - z\ell_{k-2,k-2}(z). \end{aligned}$$

The initial polynomials are $\ell_{0,0}(z) = 1 - z$, $\ell_{1,0}(z) = -1$, and $\ell_{1,1}(z) = 1 - 2z$. Furthermore, we have

$$\ell_{k,k}(z) = \sum_{n=0}^{\lfloor \frac{k+2}{2} \rfloor} (-1)^n \binom{k+2-n}{n} z^n. \tag{166}$$

Proof. The initial polynomials are given by Theorem 8.4.7. The linearity and the degree constraint follow by induction using the recursive definition of L_k . Using an ansatz and comparing coefficients gives the recurrence relations.

The closed form of the leading coefficient can be also verified by induction. Observe that the leading term depends only on the two previous leading terms. □

The asymptotic behavior of the number $r_{k,n}$ of relaxed trees with right-height at most k is governed by these differential equations [85, Chapter VII.9]. These are characterized to belong to a certain class. Consider an ordinary generating function of the kind

$$D^r Y(z) + a_1(z)D^{r-1}Y(z) + \dots + a_r(z)Y(z) = 0, \tag{167}$$

where the $a_i \equiv a_i(z)$ are meromorphic in a simply connected domain Ω . Given a meromorphic function $f(z)$, let $\omega_\zeta(f)$ be the order of the pole of f at ζ , and $\omega_\zeta(f) = 0$ meaning that $f(z)$ is analytic at ζ .

Definition 8.4.9 (Regular singularity, [85, p. 519]). *The differential equation (167) is said to have a singularity at ζ if at least one of the $\omega_\zeta(f)$ is positive. The point ζ is said to be a regular singularity if*

$$\omega_\zeta(a_1) \leq 1, \quad \omega_\zeta(a_2) \leq 2, \quad \dots, \quad \omega_\zeta(a_r) \leq r,$$

and an irregular singularity otherwise.

Definition 8.4.10 (Indicial polynomial, [85, p. 520]). *Given an equation of the form (167) and a regular singular point ζ , the indicial polynomial $I(\alpha)$ at ζ is defined as*

$$I(\alpha) = \alpha^r + \delta_1 \alpha^{r-1} + \dots + \delta_r, \quad \alpha^\ell := \alpha(\alpha-1) \cdots (\alpha-\ell+1),$$

where $\delta_i := \lim_{z \rightarrow \zeta} (z - \zeta)^i a_i(z)$. The indicial equation at ζ is the algebraic equation $I(\alpha) = 0$.

The following technical lemma will be needed to derive the asymptotics (see Theorem 8.4.12) of a special type of differential equations.

Lemma 8.4.11. *Let $p_0, \dots, p_r \in \mathbb{C}[x]$ and consider the differential operator*

$$L = p_r D^r + \dots + p_1 D + p_0.$$

Suppose that x is a simple factor of p_r , and suppose that for some $\alpha \in \mathbb{C}$, the operator L admits a generalized series solution $f(x) = \sum_{n \in \alpha + \mathbb{Z}} c_n x^n$. Then the coefficient sequence $(c_n)_{n \in \alpha + \mathbb{Z}}$ satisfies a recurrence of the form

$$\begin{aligned} & (([x^1]p_r)(n-r+1) + ([x^0]p_{r-1}))n^{r-1}c_n \\ & + [\dots](n-1)^{r-2}c_{n-1} \\ & + [\dots](n-2)^{r-3}c_{n-2} \\ & + \dots \\ & + [\dots]c_{n-s} = 0, \end{aligned}$$

where $[\dots]$ are certain polynomials in n and s is some fixed non-negative integer.

Proof. We have $x^j D^i f = \sum_{n \in \alpha + \mathbb{Z}} c_n n^i x^{n-i+j} = \sum_{n \in \alpha + \mathbb{Z}} c_{n+i-j} (n+i-j)^i x^n$ for all $i, j \in \mathbb{N}$.

Write $p_i = \sum_j p_{i,j} x^j$ for $i = 0, \dots, r$, in the understanding that j runs through all integers but $p_{i,j}$ is zero for all negative and almost all positive indices j . By assumption, we know that $p_{r,0} = 0 \neq p_{r,1}$.

It follows that $p_i D^i f = \sum_{n \in \alpha + \mathbb{Z}} \sum_j p_{i,j} c_{n+i-j} (n+i-j)^i x^n$ for $i = 0, \dots, r$, and

$$Lf = \sum_{n \in \alpha + \mathbb{Z}} \sum_{i=0}^r \sum_j p_{i,j} c_{n+i-j} (n+i-j)^i x^n = 0$$

implies, by comparing coefficients of x^n ,

$$0 = \sum_{i=0}^r \sum_j p_{i,j} c_{n+i-j} (n+i-j)^i = \sum_j \sum_{i=0}^r p_{i,i+j} (n-j)^i c_{n-j} \tag{168}$$

for all $n \in \alpha + \mathbb{Z}$.

Consider a fixed $j \in \mathbb{Z}$. From the definition $(n-j)^i = (n-j)(n-j-1) \dots (n-j-i+1)$ it follows that $(n-j)^i \mid (n-j)^{i+1}$ for every $i \in \mathbb{N}$. Therefore, if k is minimal such that $p_{k,k+j} \neq 0$, then $(n-j)^k \mid \sum_{i=0}^r p_{i,i+j} (n-j)^i$.

Note also that for each fixed j , the polynomial $\sum_{i=0}^r p_{i,i+j} (n-j)^i$ is nonzero if and only if at least one of the coefficients $p_{i,i+j}$ are nonzero, because the falling factorials form a basis of the vector space of polynomials.

For $j < -r$, we have $i+j < 0$ for all $i = 0, \dots, r$, and therefore $p_{i,i+j} = 0$ for all i and $\sum_{i=0}^r p_{i,i+j} (n-j)^i = 0$. Therefore there are no terms c_{n-j} with $j < -r$ present in equation (168).

For $j = -r$, we have $i + j < 0$ for all $i = 0, \dots, r-1$, and therefore $p_{i,i+j} = 0$ for all these i . In addition, we have $p_{r,r-r} = p_{r,0} = 0$ by assumption, so again $\sum_{i=0}^r p_{i,i+j}(n-j)^i = 0$, and no term c_{n-j} with $j = -r$ is present in equation (168).

Next, for $j = -r + 1$ we have $p_{r,r+(-r+1)} = p_{r,1} \neq 0$ by assumption, so the term $c_{n-(r-1)}$ does occur in equation (168). Moreover, since $p_{i,i+(-r+1)} = 0$ for all $i < r-1$, we have $\sum_{i=0}^r p_{i,i+j}(n-j)^i = p_{r,1}(n-j)^r + p_{r-1,0}(n-j)^{r-1} = (p_{r,1}n + p_{r-1,0})(n+r-1)^{r-1}$.

In general, for any $j > -r + 1$, we have $p_{i,i+j} = 0$ for all $i < -j$ and therefore $(n-j)^{-j} \mid \sum_{i=0}^r p_{i,i+j}(n-j)^i$. (The understanding here is that $(n-j)^{-j} = 1$ if $-j$ is not positive.) Substituting $n-r+1$ for n , we have shown the claimed form of the recurrence. \square

If ζ is a regular singularity of a differential equation, then all the solutions of the differential equations behave for $z \rightarrow \zeta$ like $(z - \zeta)^\alpha \log(z - \zeta)^\beta$ for some $\alpha \in \mathbb{C}, \beta \in \mathbb{N}$. The exponents α are the roots of the indicial polynomial, and exponents of the logarithmic terms are related to multiple roots of the indicial polynomial and roots at integer distances. More precisely, in our case the following theorem will be applicable. It is a variant of [85, Theorem VII.9] which works due to $\omega_\zeta(a_i) = 1$ for all $i = 1, \dots, r$.

Theorem 8.4.12. *Consider a differential equation (167) and a regular singular point ζ such that $\omega_\zeta(a_i) = 1$ for all $i = 1, \dots, r$, and $\delta_1 := \lim_{z \rightarrow \zeta} (z - \zeta)a_1(z) \geq 0$. Then, the vector space of analytic solutions defined in a slit neighborhood of ζ has a basis of $r-1$ analytic solutions*

$$(z - \zeta)^m H_m(z - \zeta), \quad m = 0, 1, \dots, r-2,$$

where H_m are analytic at 0 with $H_m(0) \neq 0$. The r -th basis function depends on δ_1 :

1. For $\delta_1 \in \{0, 1, \dots, r-1\}$ it is of the form

$$(z - \zeta)^{r-1-\delta_1} H(z - \zeta) \log(z - \zeta);$$

2. For $\delta_1 \in \{r, r+1, \dots\}$ it is of the form

$$(z - \zeta)^{r-1-\delta_1} H(z - \zeta) + H_0(z - \zeta) (\log(z - \zeta))^k, \quad k \in \{0, 1\};$$

3. For $\delta_1 \notin \mathbb{Z}$ it is of the form

$$(z - \zeta)^{r-1-\delta_1} H(z - \zeta);$$

where H is analytic at 0 with $H(0) \neq 0$.

Proof. Due to $\omega_\zeta(a_i) = 1$ we get by the definition of the indicial polynomial that $\delta_i = 0$ for $i \geq 2$. Hence, it is given by

$$I(\alpha) = \alpha^r + \delta_1 \alpha^{r-1} = \alpha^{r-1}(\alpha - r + 1 + \delta_1).$$

Therefore, the roots are $0, 1, \dots, r - 2$, and $r - 1 - \delta_1$.

Let us treat the consecutive range of roots $0, 1, \dots, r - 2$ first. Consider the equivalent recurrence relation of the coefficients $(c_n)_{n \in \mathbb{N}}$ of the series solution expanded at ζ and associated to the differential equation. It has the form

$$I(n)y_n = \Phi(y_{n-1}, \dots, y_{n-N}),$$

where $I(n)$ is the indicial polynomial, $N = \max_i(r + \deg(a_i))$, and Φ is a linear operator with polynomial coefficients in n . Let α be a root of the indicial polynomial, and consider the sequence $(c_n)_{n \in \mathbb{N}}$ extended to \mathbb{Z} with $c_n = 0$ for $n < \alpha$ for $\alpha = 0, 1, \dots, r - 2$. At $n = \alpha$ we have

$$0 \cdot y_\alpha = \Phi(0, \dots, 0). \tag{169}$$

Hence, y_m can be chosen arbitrarily. By Lemma 8.4.11 for each choice, the recurrence uniquely extends the sequence towards $+\infty$. Therefore, each root α gives rise to a different solution of our recurrence relation. The set of all these solutions is linear independent. The consecutive range of zeros implies that the values y_0, \dots, y_{r-2} can be chosen arbitrarily, as they do not interfere with each other. Such a situation does not give rise to any log-terms.

Next, let us treat the missing basis solution associated to $r - 1 - \delta_1$.

In the first case, there is a multiple root of order 2. Then, the classical theory of linear differential equations implies the appearance of logarithmic terms, see [104, 114, 163, 184].

In the second case, it is analogous to (169): The solution starts to exist at $n = r - 1 - \delta_1$. But this solution then needs to be continued further, and at $n = 0$ we might have a problem. Then, there might emerge a log term or not, this depends on the specific problem. If the solution cannot be extended, then a log term multiplied to the solution at $n = 0$ is added, see [114].

In the third case, the root does not interfere with the other solutions, as it is not in the same modulo class mod 1. Thus, it can be continued without problems, and has the claimed form. \square

Remark 27. Theorem 8.4.12 treats only the case of consecutive zeros at the beginning. Note however that one might run into trouble in a situation with roots like $\{0, 1, 2, 5\}$. In this case it is clear that there exists a solution with y_5 arbitrary and $y_n = 0$ for $n < 5$. This solution can be extended indefinitely by the recurrence towards the right. We further expect three linearly independent solutions starting at 0, 1, 2, respectively. A full three dimensional space of such solutions may however not exist, because we must choose y_0, y_1, y_2 in such a way that the recurrence extends them to y_4, y_5 in accordance with the requirement

$$0 \cdot y_5 = \phi_1 c_4 + \phi_2 c_3 + \dots \tag{170}$$

as the recurrence is supposed to hold everywhere. In general, the requirement for the right-hand side to be zero forces a linear constraint on the initial values y_0, y_1, y_2 , reducing the expected 3-dimensional solution space to a 2-dimensional one. In this situation, the clash can be repaired by introducing a log into the series of which y_n is the coefficient sequence. It can also happen that the right-hand side of (170) accidentally is zero for any choice of y_0, y_1, y_2 , because of certain relation between the coefficient polynomials ϕ_1, ϕ_2, \dots . In this case, we have only power series solutions and it is not necessary (and not possible) to create a solution with a log-term.

Series solutions with higher powers of logarithms appear if and only if the phenomenon described above happens several times as we walk through the index range. This is impossible when the roots are 0, 1, 2, 5, but it may already happen for 0, 1, 2, 5, 6.

By Theorem 8.4.7 the differential equations of relaxed trees are of the kind (167). The roots of the leading term are under these conditions responsible for the singularities. The dominant one is as usual the one closest to the origin. Our first aim is to show that for every bounded right-height there exists a unique dominant singularity.

We start with the analysis of the leading polynomials. The coefficient $\ell_{k,k}(z)$ has a nice bivariate generating function representation.

The following results are supplemented by the ones in Section 8.6 which are often more general and more explicit. After the first version of this thesis had been submitted to the referees the simplifications of Section 8.6 were discovered. This subsequent discussion shows the necessary steps if nothing is known about the polynomials. Then, properties like having real, positive, and distinct roots, need to be proven. Yet in our case, we discovered that the polynomials we are dealing with are transformations of the well-known Chebyshev polynomials. We decided to add this part in order to show two parallel techniques of deriving the needed results. Thus, the following technical discussions can be skipped and replaced with the (less technical) ones of Section 8.6. But note that both lead to the same results.

Lemma 8.4.13 (Bivariate generating function of leading coefficient). *Let $L(x, z) = \sum_{n,k \geq 0} \ell_{k,k}(z)x^k$ be the bivariate generating function of the leading coefficient of the L_k operators. Then,*

$$L(x, z) = \frac{1 - z - xz}{1 - x + zx^2}. \quad (171)$$

Proof. We start from the closed form of $\ell_{k,k}(z)$ given in (166). Note that the upper limit can be set to ∞ , as the binomial coefficients are zero for large n . Then,

$$\begin{aligned} L(x, z) &= \sum_{k \geq 0} \sum_{n \geq 0} \binom{k+2-n}{n} (-z)^n x^k \\ &= \sum_{n \geq 0} (-z)^n \sum_{k \geq 0} \binom{n+k}{n} x^{k+2n-2} - \frac{1}{x} - \frac{1}{x^2} \\ &= \frac{x^{-2}}{1-x} \sum_{n \geq 0} \left(-\frac{zx^2}{1-x} \right)^n - \frac{x+1}{x^2} = \frac{x^{-2}}{1-x+zx^2} - \frac{x+1}{x^2}, \end{aligned}$$

where we used that $\sum_{k \geq 0} \binom{n+k}{n} x^k = \frac{1}{(1-x)^{n+1}}$, see for example [187, Equation (2.5.7)]. Simplifying this expression shows the claim. \square

This bivariate generating function also helps us to get a different representation of the leading coefficient. It will be the key to find the exponential growth of compacted (relaxed) trees.

Lemma 8.4.14 (Leading coefficient via Catalan generating function).

Let $B(z) = \frac{1-\sqrt{1-4z}}{2}$ be the generating function¹ of the Catalan numbers, and $\bar{B}(z) = \frac{1+\sqrt{1-4z}}{2}$. Then,

$$\ell_{k,k}(z) = \frac{1}{\sqrt{1-4z}} \left(\bar{B}(z)^{k+3} - B(z)^{k+3} \right). \tag{172}$$

Proof. Solving the denominator of (171) with respect to x we see that $B(z)/z$ and $\bar{B}(z)/z$ are its roots. A partial fraction decomposition of the Laurent representation gives for $k \geq 0$

$$[x^k]L(x, z) = [x^k] \frac{z^3}{\sqrt{1-4z}} \left(-\frac{B(z)^{-2}}{xz - B(z)} + \frac{\bar{B}(z)^{-2}}{xz - \bar{B}(z)} \right).$$

Finally, extracting coefficients and using that $B(z)\bar{B}(z) = z$ shows the claim. \square

We now apply this lemma twice. First, we show that there is no root in the open domain $|z| < \frac{1}{4}$.

Proposition 8.4.15. *There is no root of $\ell_{k,k}(z)$ inside the open disc $|z| < \frac{1}{4}$. Furthermore, for sufficiently large k there is no root inside the domain*

$$\left\{ z : |z| < \frac{1}{4} \left(1 + \frac{2\pi^2}{k^2} + \mathcal{O}\left(\frac{1}{k^3}\right) \right) \right\} \setminus \left[\frac{1}{4}, +\infty \right).$$

Proof. Representation (172) is a priori valid for $|z| < \frac{1}{4}$. Let z_0 be a root inside this domain. Then, we must have

$$\left(1 + \sqrt{1-4z_0} \right)^{k+3} = \left(1 - \sqrt{1-4z_0} \right)^{k+3}. \tag{173}$$

¹ In order not to conflict with our notation, we use the notation $B(z)$ instead of the commonly used $C(z)$. The letter B should remind you of binary trees.

Let $\omega = \exp\left(\frac{2\pi i}{k+3}\right)$ be a $(k+3)$ -rd root of unity. Then this expression is equivalent to the existence of a $j \in \{0, \dots, k+2\}$ such that

$$z_0 = \frac{1}{4} \left(1 - \frac{(1 - \omega^j)^2}{1 + \omega^j}\right), \quad \Re(z_0) = \frac{1}{4} \left(1 + \frac{1 - \cos\left(\frac{4\pi j}{k+3}\right)}{2 + \cos\left(\frac{2\pi j}{k+3}\right)}\right).$$

This however implies $\Re(z_0) \geq \frac{1}{4}$ contradicting $|z_0| < \frac{1}{4}$. Note that this representation is not valid for $\omega^j = -1$, which appears for k odd and $j = \frac{k+3}{2}$. Such a case is by (173) not possible.

In order to show the second claim, note that by cutting the complex plane along the ray $[\frac{1}{4}, +\infty)$ on the positive real axis we create a domain in which $\ell_{k,k}(z)$ can be uniquely extended. For sufficiently large k the cosines in $\Re(z_0)$ can be expanded in a series, and the same reasoning yields the result. \square

Using Lemma 8.4.14 a second time establishes another closed form of $\ell_{k,k}(z)$, which is expanded at $z = 1/4$. By doing so, we find the smallest real root.

Proposition 8.4.16. *Let ρ_k be the smallest real root of $\ell_{k,k}(z)$. Then, we have $\rho_k \in (\frac{1}{4}, \frac{1}{4}(1 + \frac{10}{k^2}))$ and $\rho_{k+1} < \rho_k$ for $k \geq 0$.*

Proof. For the first claim we start from (172). Let us use the shorthand $x = \sqrt{1 - 4z}$ to increase readability. Then, by the binomial theorem we have

$$\begin{aligned} \ell_{k,k}(z) &= \frac{1}{2^{k+3}} \frac{(1+x)^{k+3} - (1-x)^{k+3}}{x} \\ &= \frac{1}{2^{k+2}} \sum_{i=0}^{\lfloor \frac{k+2}{2} \rfloor} \binom{k+3}{2i+1} x^{2i} \\ &= \frac{1}{2^{k+2}} \sum_{i=0}^{\lfloor \frac{k+2}{2} \rfloor} \binom{k+3}{2i+1} (1-4z)^i. \end{aligned} \tag{174}$$

As odd powers cancel, we obtain a polynomial expression. Note that the first expression was only valid for $|z| < 1/4$, however, the polynomial is analytic on \mathbb{C} . As they are equal on the disc, it is the unique analytic continuation.

This representation implies that $\ell_{k,k}(z) > 0$ for $z \leq 1/4$. However, in a close neighborhood of $z_0 = \frac{1}{4}(1 + \frac{10}{k^2})$ we claim

$$\ell_{k,k}(z_0) = \frac{1}{2^{k+2}} \sum_{i=0}^{\lfloor \frac{k+3}{2} \rfloor} (-1)^i \binom{k+3}{2i+1} \frac{10^i}{k^{2i}} < 0.$$

The absolute value of the summands is for $i > 0$ a monotonically decreasing sequence. Let S_m be the m -th partial sum

$$S_m = \frac{1}{2^{k+2}} \sum_{i=0}^m (-1)^i \binom{k+3}{2i+1} \frac{10^i}{k^{2i}}.$$

As it is an alternating sum and $S_0 = 1$ we get $S_{2n-1} \leq l_{k,k}(z_0) \leq S_{2n}$ for $n \geq 1$. Finally, one easily shows that $S_3 < 0$ and $S_4 < 0$. By continuity there exists a root inside the claimed interval.

For the second claim, we start with (166). W.l.o.g. we assume k to be even. As $l_{k,k}(\rho_k) = 0$ we have

$$\begin{aligned}
 l_{k+1,k+1}(\rho_k) &= l_{k+1,k+1}(\rho_k) - l_{k,k}(\rho_k) \\
 &= \sum_{n=0}^{\lfloor \frac{k+2}{2} \rfloor} (-1)^n \underbrace{\left(\binom{k+3-n}{n} - \binom{k+2-n}{n} \right)}_{=: a_n} \rho_k^n.
 \end{aligned}$$

This is again an alternating sum, as $a_n \geq 0$. We consider the partial sums $S'_m = \sum_{n=0}^m (-1)^n a_n \rho_k^n$. As $a_0 = 0$ we get $S'_0 = 0$ and $S'_1 < 0$. Hence, we conclude $l_{k+1,k+1}(\rho_k) < 0$. This implies $\rho_{k+1} < \rho_k$, as ρ_{k+1} is the smallest positive root and $l_{k,k}(0) = 1$. \square

Remark 28. With the same techniques one can derive a lower bound for ρ_k and show that it lies in the interval $(\frac{1}{4}(1 + \frac{9}{k^2}), \frac{1}{4}(1 + \frac{10}{k^2}))$. Thus, the upper bound is a very good approximation of the actual value.

But ρ_k is not the only positive root of $\ell_{k,k}(z)$. Much more is true: all its roots are positive. Not much is known about real-rootedness of polynomial families. However, we can adapt a result from [138] exactly dealing with our situation.

Proposition 8.4.17 ([138, Variant of Corollary 2.4]). *Let $\{P_n(z)\}$ be a sequence of polynomials that satisfies the recurrence relation*

$$P_n(z) = \alpha_n(z)P_{n-1}(z) + \beta_n(z)P_{n-2}(z),$$

where $\alpha_n(z)$ and $\beta_n(z)$ are polynomials such that $\deg P_n = \deg P_{n-1}$ or $\deg P_{n-1} + 1$. If for each n the coefficients of $P_n(z)$ are alternating in sign and $\beta_n(z) \leq 0$ for $z \geq 0$ all roots of $P_n(z)$ are real and positive.

Note that Descartes' rule of signs directly implies for alternating signs that all roots have to be positive if they are real. Now it is easy to give the result of our initial problem.

Corollary 8.4.18. *All roots of $\ell_{k,k}(z)$, $k \geq 0$ are real, positive, and distinct.*

Proof. Lemma 8.4.8 implies that all conditions of Proposition 8.4.17 are satisfied for $\{\ell_{k,k}(z)\}$. Thus, all roots are real and positive.

Next, assume $r \neq 0$ to be a multiple root of $\ell_{k,k}(z)$. Hence, from the closed-form (172) we deduce that

$$\bar{B}(r)^{k+3} = B(r)^{k+3}.$$

A multiple root is also a root of the derivative, thus $\ell'_{k,k}(r) = 0$. But this implies, again by (172) and the previous identity that

$$0 = \ell'_{k,k}(r) = -\frac{1}{r^2} \frac{k+3}{1-4r} B(r)^{k+3} = -\frac{1}{r^2} \frac{k+3}{1-4r} \left(\frac{1 - \sqrt{1-4r}}{2} \right)^{k+3},$$

which gives a contradiction. \square

Remark 29. One can show even more: With [138, Lemma 2.5] one gets that the roots of $\ell_{k,k}(z)$ and $\ell_{k+1,k+1}(z)$ are interlaced. That means that after ordering the roots of both polynomials in an increasing order, they are alternating in the sense that the smallest one belongs to $\ell_{k+1,k+1}(z)$, the next one belongs to $\ell_{k,k}(z)$, the next one to $\ell_{k+1,k+1}(z)$ again, and so on.

Remark 30. On the one hand, by its definition it is easy to see that the coefficients of $\ell_{k,k}(-z)$ are an ultra log concave sequence. On the other hand, it is known that polynomials with real coefficients and only real roots have ultra log concave coefficients. Note that the converse is not true. This notion was introduced by Pemantle [152], see also [136, 183]. A finite sequence $a_k, 0 \leq k \leq n$ is ultra log concave, if the sequence $a_k / \binom{n}{k}$ is log concave, and it is log concave if $a_i^2 \geq a_{i-1}a_{i+1}$ for all $0 < i < n$.

In order to analyze the other polynomials we need the following lemmas.

Lemma 8.4.19. For $k \geq 2$ and $0 \leq i \leq \lfloor \frac{k-2}{2} \rfloor$ we have $\ell_{k,i}(z) \equiv 0$.

Proof. Let us start with the cases $i = 0$ and $i = 1$. By definition in Lemma 8.4.8 we have $\ell_{k,0}(z) = 0$ for $k \geq 2$. The case $i = 1$ is valid for $k \geq 4$. Then, we have

$$\ell_{k,1}(z) = \ell_{k-1,0}(z) - \ell_{k-2,0}(z) = 0.$$

For the cases $i \geq 0$ we use induction on k . Assume the claim holds for $2, \dots, k-1$ and arbitrary i . Then, we have

$$\ell_{k,i}(z) = \ell_{k-1,i-1}(z) - (i+1)\ell_{k-2,i-1}(z) - z\ell_{k-2,i-2}(z) = 0.$$

In all three cases it is easy to check that $i \leq \lfloor \frac{k-2}{2} \rfloor$ implies by the induction hypothesis that these terms are equal to 0. \square

Lemma 8.4.20. Let ρ_k be the smallest real root of $\ell_{k,k}(z)$. Then, the polynomials $\ell_{k,i}(z)$ for $\lfloor \frac{k}{2} \rfloor \leq i \leq k-1$ have no root in the interval $[0, \rho_k]$.

Proof. We will show by induction on k that the polynomials are either strictly positive or strictly negative in the specified interval. The first thing we notice is that $\ell_{k,k}(z) \geq 0$ in $[0, \rho_k]$ as $\ell_{k,k}(0) = 1$ by (166). In particular, we will show

$$\begin{cases} \ell_{k,i}(z) > 0, & \text{for } k-i \text{ even,} \\ \ell_{k,i}(z) < 0, & \text{for } k-i \text{ odd.} \end{cases}$$

The initial cases are true by $\ell_{1,0}(z) = -1$, $\ell_{2,1}(z) = 2z - 3$, $\ell_{3,1}(z) = 2$, and $\ell_{3,2}(z) = 9z - 6$. In all other cases we have $i \geq 2$.

Assume the hypothesis holds for $k \in \{2, \dots, k-1\}$ and arbitrary i . The intervals $[0, \rho_k]$ are decreasing subsets, i.e., $[0, \rho_k] \subset [0, \rho_{k-1}]$.

Thus, by the hypothesis fixed polynomials stay positive or negative if k increases.

Let us now investigate the indices in the recursion of Lemma 8.4.8:

$$\ell_{k,i}(z) = \underbrace{\ell_{k-1,i-1}(z)}_{k-i \pmod 2} - (i+1) \underbrace{\ell_{k-2,i-1}(z)}_{k-i-1 \pmod 2} - z \underbrace{\ell_{k-2,i-2}(z)}_{k-i \pmod 2}.$$

Observe that the “ $-$ ” in front of the last two terms changes the sign. Hence, the first two terms are either both strictly positive or negative. However, the last one has a different sign. The idea is now to apply the recursion repeatedly on the first term. In order to simplify notation we define

$$e_j(z) := \ell_{k-j,i-j}(z).$$

This gives

$$\begin{aligned} e_0(z) &= e_1(z) - ze_2(z) - (i+1)\ell_{k-2,i-1}(z) \\ &= \underbrace{(1-z)}_{=\ell_{0,0}(z)} e_2(z) - ze_3(z) - (i+1)\ell_{k-2,i-1}(z) - i\ell_{k-3,i-2}(z). \end{aligned}$$

Note that, as discussed above, the last term will always have the same sign as the left-hand side. Thus, it has no influence and we can neglect it. By this argument the sign is the same as the one of the recursion

$$\bar{e}_j(z) = \bar{e}_{j+1}(z) - z\bar{e}_{j+2}(z),$$

where we want to find the sign of $e_0(z)$. By Lemma 8.4.19 the recursion terminates. In particular $\bar{e}_j(z) \equiv 0$ for $i-j \leq \lfloor \frac{k-j}{2} \rfloor - 1$. Let j_0 be the smallest j such that this happens. It is given by

$$j_0 = \begin{cases} 2 \left(i - \lfloor \frac{k}{2} \rfloor \right) + 2, & \text{for } k \text{ even,} \\ 2 \left(i - \lfloor \frac{k}{2} \rfloor \right) + 1, & \text{for } k \text{ odd.} \end{cases}$$

Finally, this recurrence is the same as the one for $l_{k,k}(z)$. Thus, we know its behavior and get

$$\begin{aligned} \ell_{k,i}(z) &= e_0(z) = \ell_{j_0-2,j_0-2}(z)e_{j_0-1}(z) + h(z) \\ &= \ell_{j_0-2,j_0-2}(z)\ell_{k-j_0+1,i-j_0+1}(z) + h(z), \end{aligned}$$

where the function $h(z)$ is a sum of neglected polynomials with the sign $(-1)^{k-i}$, which of course also holds for $\ell_{k-j_0+1,i-j_0+1}(z)$. And the function $\ell_{j_0-2,j_0-2}(z) \geq 0$ on $[0, \rho_k]$ and does not influence the sign. By the induction hypothesis the claim holds. \square

With this information we are finally able to characterize the indicial polynomials.

Proposition 8.4.21. *The indicial polynomial $I_k(\alpha)$ of the k -th differential equation is given by $I_k(\alpha) = \alpha^{k-1}(\alpha - (\frac{k}{2} - 1))$.*

Proof. By Definition 8.4.10 we need to show that $\delta_i = 0$ for $i \geq 1$ and $\delta_1 = \frac{k}{2}$. The first claim holds by Lemma 8.4.20, as the pole of $\ell_{k,i}(z)/\ell_{k,k}(z)$ is a simple one for $i \geq 1$.

Let us reformulate the second claim.

$$\delta_1 = \lim_{z \rightarrow \rho_k} \frac{\ell_{k,k-1}(z)}{\frac{\ell_{k,k}(z)}{z-\rho_k}} = \frac{\ell_{k,k-1}(\rho_k)}{\ell'_{k,k}(\rho_k)} \stackrel{?}{=} \frac{k}{2}, \tag{175}$$

where the second equality sign holds because of L'Hospital's rule and Lemma 8.4.20 (ρ_k is not a root of $\ell_{k,k-1}(z)$). The last equality still needs to be proved. To finish the proof we will show the stronger claim:

$$\ell_{k,k-1}(z) = \frac{k}{2} \ell'_{k,k}(z),$$

for $k \geq 1$ and arbitrary z . From Lemma 8.4.8 it holds for $k = 1$ and $k = 2$. We proceed by induction. Assume the claim holds for $1 \leq i \leq k$. Then, differentiating the defining equation of $\ell_{k,k}(z)$ from Lemma 8.4.8 we get

$$\ell'_{k,k} = \ell'_{k-1,k-1} - z\ell'_{k-2,k-2} - \ell_{k-2,k-2}.$$

Next, we apply the induction hypothesis and get

$$= \frac{2}{k-1} \ell_{k-1,k-2} - z \frac{2}{k-2} \ell_{k-2,k-3} - \ell_{k-2,k-2}.$$

Rearranging the equation and utilizing the defining recurrence relation of $\ell_{k,k-1}$ gives

$$\begin{aligned} &= \frac{2}{k} \left(\underbrace{\ell_{k-1,k-2} - z\ell_{k-2,k-3} - k\ell_{k-2,k-2}}_{=\ell_{k,k-1}} \right) \\ &\quad + \frac{1}{k} \left(\underbrace{\ell_{k-1,k-1} - 2z\ell'_{k-2,k-2} + k\ell_{k-2,k-2}}_{=0} \right). \end{aligned}$$

The last expression is equal to 0 as we know the polynomial $\ell_{k,k}(z)$ explicitly from (172) in terms of the Catalan generating function. \square

With the help of Lemma 8.4.19 we are able to simplify the indicial polynomials further. The reason is that the differential equation of order k is actually a differential equation of order

$$\tilde{r} := \left\lceil \frac{k}{2} \right\rceil \quad \text{for the function} \quad \tilde{R}_k(z) := \frac{d^{\lfloor \frac{k}{2} \rfloor}}{dz^{\lfloor \frac{k}{2} \rfloor}} R_k(z).$$

In other words,

$$\ell_{k,k}(z) D^{\tilde{r}} \cdot \tilde{R}_k + \ell_{k,k-1}(z) D^{\tilde{r}-1} \cdot \tilde{R}_k + \dots + \ell_{k, \lfloor \frac{k}{2} \rfloor}(z) \tilde{R}_k = 0. \tag{176}$$

Corollary 8.4.22. *Let $\tilde{I}_k(\alpha)$ be the indicial polynomial of the reduced differential equation (176). Then,*

$$\tilde{I}_k(\alpha) = \begin{cases} \alpha^{\tilde{r}-1}(\alpha + 1), & \text{if } k \text{ even,} \\ \alpha^{\tilde{r}-1}(\alpha + \frac{1}{2}), & \text{if } k \text{ odd.} \end{cases}$$

Proof. This is a direct consequence of Proposition 8.4.21. As only the order of the differential equation changed but not the coefficients, we get

$$\tilde{I}_k(\alpha) = \alpha^{\tilde{r}} + \delta_1 \alpha^{\tilde{r}-1} = \alpha^{\tilde{r}-1} \left(\alpha - \left\lfloor \frac{k}{2} \right\rfloor + \frac{k}{2} + 1 \right).$$

Considering the even and odd case separately yields the result. □

After these technical steps, we finally arrive at our first main result.

Theorem 8.4.23 (Asymptotics of relaxed binary trees with bounded right-height). *The number $r_{k,n}$ of relaxed trees with right-height at most k is given asymptotically equal to*

$$r_{k,n} \sim \gamma_k n! \rho_k^{-n} n^{-k/2},$$

where $\rho_k \in (\frac{1}{4}, \frac{1}{4}(1 + \frac{10}{k^2}))$ is the unique minimal real root of $l_{k,k}(z)$, and a constant $\gamma_k \in \mathbb{R}$.

Proof. Firstly, by Propositions 8.4.15 and 8.4.16 the real root ρ_k is the closest one to the origin and unique in the disc of convergence.

Secondly, Lemma 8.4.20 shows that it is a simple pole of $\frac{\ell_{k,i}(z)}{\ell_{k,k}(z)}$ for $i = 1, \dots, k - 1$. Thus, by Definition 8.4.9 it is a regular singularity.

Thirdly, by Corollary 8.4.22 the roots of the reduced indicial polynomial are either $\{-1, 0, 1, \dots, \tilde{r} - 2\}$ for k even, or $\{-\frac{1}{2}, 0, 1, \dots, \tilde{r} - 2\}$ for k odd. In both cases by Theorem 8.4.12 a basis in a slit neighborhood of ρ_k consists of the analytic functions

$$(1 - z/\rho_k)^s H_s(1 - z/\rho_k),$$

for $s = 0, \dots, \tilde{r} - 2$ and analytic function H_s at 0, and a singular function

$$\begin{cases} \frac{1}{1-z/\rho_k} H(1 - z/\rho_k) + G(1 - z/\rho_k) \log(1 - z/\rho_k), & \text{if } k \text{ is even,} \\ \frac{1}{\sqrt{1-z/\rho_k}} H(1 - z/\rho_k), & \text{if } k \text{ is odd,} \end{cases}$$

with analytic functions G, H at 0. This is a basis for $\tilde{R}_k(z)$.

In order to obtain a basis for $R_k(z)$ we need to integrate $\lfloor \frac{k}{2} \rfloor$ times. The analytic basis functions remain analytic and the singular ones singular. As there is always just one singular function, but we know that they are singular at ρ_k , these must be responsible for the asymptotic growth. In both cases we get the singular expansion for $z \rightarrow \rho_k$ of the kind

$$R(z) \sim \gamma_k (1 - z/\rho_k)^{k/2-1}.$$

Finally, applying the transfer theorems, the claim holds. Note that in the even case there might be a polynomial in front of the log-term yielding a coefficient asymptotic of $n^{-k/2}$. \square

Let us comment on the even case. It is a priori not clear if this logarithmic term appears or not (if not we set $G \equiv 0$). But due to the appearance of the term with the polar singularity, the logarithmic term does not influence the asymptotic main term. Obviously, it plays a role for the error terms. For specific cases we can of course answer this question. For $k = 2$ we have seen in Section 8.4 that there are no log terms. However, in this case the reduced indicial polynomial is only of order 1, see Corollary 8.4.22. Therefore, the consecutive range of roots starting with 0 does not exist.

But they appear in the case of $k = 4$. In particular, we have the operator

$$(-z^3 + 6z^2 - 5z + 1)D^2 + (-6z^2 + 24z - 10)D + (11 - 6z)$$

and the expansion point ρ_4 , that is a root of $-z^3 + 6z^2 - 5z + 1$. Then, the solution space is generated by the following two series:

$$\begin{aligned} & 1 \\ & - \frac{48\rho_4^2 - 267\rho_4 + 118}{14}(\rho_4 - z) \\ & + \frac{249\rho_4^2 - 2340\rho_4 + 5560}{588}(\rho_4 - z)^2 \\ & - \frac{206442\rho_4^2 - 1141941\rho_4 + 502699}{7056}(\rho_4 - z)^3 \\ & + \mathcal{O}((\rho_4 - z)^4), \end{aligned}$$

$$\begin{aligned} & (z - \rho_4)^{-1} + 0(z - \rho_4)^{-1} \log(z - \rho_4) \\ & + 0 - \frac{6\rho_4^2 - 33\rho_4 + 14}{7} \log(z - \rho_4) \\ & + \frac{159\rho_4^2 - 888\rho_4 + 440}{196}(\rho_4 - z) + \frac{3\rho_4^2 - 54\rho_4 + 194}{98}(\rho_4 - z) \log(z - \rho_4) \\ & - \frac{2484\rho_4^2 - 14439\rho_4 + 9541}{1764}(\rho_4 - z)^2 - \frac{3834\rho_4^2 - 21183\rho_4 + 9221}{588}(\rho_4 - z)^2 \log(z - \rho_4) \\ & + \mathcal{O}((\rho_4 - z)^3 \log(z - \rho_4)). \end{aligned}$$

8.5 COMPACTED BINARY TREES

After the successful application of exponential generating functions to relaxed trees of bounded right-height, we will extend this method to compacted binary trees. In this context we introduce the following notation: Let \mathcal{C} be the combinatorial class of compacted trees. Its exponential generating function is given by $C(z) = \sum_{n \geq 0} c_n \frac{z^n}{n!}$ where c_n denotes the number of elements in \mathcal{C} of size n . In this section we solve the problem of finding the generating function of compacted trees of

bounded right-height. We denote the class of compacted trees of right-height at most k by \mathcal{C}_k and its corresponding exponential generating function by $C_k(z) = \sum_{n \geq 0} c_{k,n} \frac{z^n}{n!}$.

As every subtree in a relaxed tree of right-height at most 0 is unique, we immediately get by Corollary 8.3.3

$$C_0(z) = \frac{1}{1-z}.$$

In order to handle the uniqueness of the subtrees we need to understand the cherries. By Proposition 8.1.5 this will guarantee uniqueness.

The cherry operator

We start with the subclass \mathcal{C}_1 of compacted trees of right-height at most 1. The same ideas as in Section 8.4 will work. However, this case is more subtle as we have to guarantee uniqueness of the subtrees. The main observation in this context is that in order to establish uniqueness of the subtrees one needs to restrict the pointers of the cherries, see Proposition 8.1.5.

Consider a situation where the pointers of a cherry are pointing into a tree of size k . Thus, every pointer has $k + 1$ (leaf!) possibilities. In a relaxed setting this would mean that there are $(k + 1)^2$ different configurations.

In a compacted tree every internal node (or spine node) corresponds to a unique subtree. Therefore, the cherry has only $(k + 1)^2 - k$ different options. Let us introduce the corresponding operator now.

Lemma 8.5.1 (Cherry operator). *Let \mathcal{C} be a class of compacted trees. Let \mathcal{K} be the class obtained from \mathcal{C} by adding a new node with two pointers, where the (decompacted) tree of this new node (left pointer is left child, right pointer is right child) is not part of \mathcal{C} . Then,*

$$\begin{aligned} K(z) &= z(zC(z))' - \int zC'(z) dz \\ &= z^2C'(z) + \int C(z) dz. \end{aligned}$$

Proof. The first term corresponds to the (unconstrained) operation of adding a root with two pointers, see (159). The second one is responsible for the correction, by deleting the number of subtrees which are already part of \mathcal{C} , see Figure 57:

Consider a tree of \mathcal{C} of size k . The integrand creates a pointer attached to the root possibly pointing to all elements of the subtree. The integration operator adds a new root node without a pointer. By attaching the newly created pointer to this new root, and changing the pointer in the case of it pointing to the leaf by letting it point to the old root, we generate k new elements from this specific tree. (A new

root with a pointer to every internal node of the tree.) This is exactly the number of elements which we need to subtract in order to ensure uniqueness.

The second representation results from an integration by parts. \square

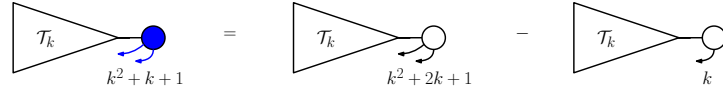

Figure 57: The construction of the cherry operator. The formulae below the pointers state the possible destinations of the pointers in the tree \mathcal{T}_k . The left tree is the desired one, the other ones are constructible ones.

Let us also define the corresponding operator $K(\cdot)$ which performs the previous operation:

$$K(C(z)) := z(zC(z))' - \int zC'(z) dz.$$

Next, we decompose $C_1(z)$ into

$$C_1(z) = \sum_{\ell \geq 0} C_{1,\ell}(z),$$

where $C_{1,\ell}(z)$ is the exponential generating function of compacted trees of right-height at most 1 with exactly ℓ right-subtrees on level 0.

Corollary 8.5.2. *The generating function of compacted trees with exactly ℓ right-edges in the spine from level 0 to level 1 is given by*

$$C_{1,\ell}(z) = \frac{1}{1-z} K(C_{1,\ell-1}(z)), \quad \ell \geq 1,$$

$$C_{1,0}(z) = \frac{1}{1-z}.$$

Proof. The construction is exactly the same as in Corollary 8.4.2. The only difference is the use of the cherry operator in (159). \square

Theorem 8.5.3. *The exponential generating function of compacted trees of right-height at most 1 is D-finite and satisfies*

$$(1 - 2z)C_1''(z) - (3 - z)C_1'(z) = 0, \quad C_1(0) = 1, \quad C_1'(0) = 1.$$

The closed form for $C_1'(z)$, and the asymptotics of the coefficients are given by

$$C_1'(z) = \frac{e^{z/2}}{(1 - 2z)^{5/4}}, \quad c_{1,n} = \frac{e^{1/4}}{\Gamma(1/4)} \frac{n!2^{n+1}}{n^{3/4}} \left(1 + \mathcal{O}\left(\frac{1}{n}\right)\right).$$

Proof. Summing the result of Corollary 8.5.2 for $l \geq 1$, and interchanging summation, differentiation, and integration by linearity gives

$$(1 - 2z)C_1'(z) - C_1(z) - (1 - z) \left((1 - z)C_{1,0} \right)' - \int zC_1'(z) dz = 0.$$

Due to the remaining integral we differentiate both sides once more and get

$$(1 - 2z)C_1''(z) - (3 - z)C_1'(z) - \left((1 - z) \left((1 - z)C_{1,0} \right)' \right)' = 0. \tag{177}$$

Inserting $C_{1,0}(z) = C_0(z) = \frac{1}{1-z}$ we get the claimed differential equation

$$(1 - 2z)C_1''(z) - (3 - z)C_1'(z) = 0$$

It can be solved by separation of variables with respect to $C_1'(z)$. The asymptotics follow then directly from this representation. \square

Compacted trees of bounded right-height

Let $C_2(z)$ decomposed such that

$$C_2(z) = \sum_{\ell \geq 0} C_{2,\ell}(z),$$

where $C_{2,\ell}(z)$ is the exponential generating function of compacted trees of right-height at most 2 with exactly ℓ right-subtrees on level 0. Obviously, we have $C_{2,0}(z) = \frac{1}{1-z}$.

In the sequel we will use the notation for operators introduced in Section 8.3 to simplify notation.

Proposition 8.5.4. *The generating function of compacted trees with right-height at most 2, and exactly ℓ right-edges in the spine from level 0 to level 1 is for $\ell \geq 1$ given by*

$$\begin{aligned} C_{2,\ell}(z) &= C_{2,\ell,A}(z) + C_{2,\ell,B}(z), \\ C_{2,\ell,A}(z) &= A(C_{2,\ell-1}(z)), \\ \bar{D}_2(C_{2,\ell,B}(z)) &= \bar{H}_2(C_{2,\ell-1}(z)), \end{aligned}$$

with the linear operators $A = S \cdot I \cdot S \cdot K$, $\bar{D}_2 = M_1 \cdot D \cdot S^{-1}$, $\bar{H}_2 = (H_1 - M_1) \cdot (D \cdot z + S \cdot K)$, and M_1 and H_1 are defined in Equations (178) and (179), respectively.

Proof. Using the same ideas as in the case of relaxed trees, we reduce the number of levels by deleting the initial sequence, and moving the last sequence to the end of the next lower level, compare Figure 55. This produces an instance of $C_1(z)$ with

- a new initial condition $\hat{C}_{2,0}(z)$ and

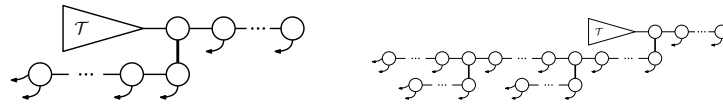

Figure 58: The 2 possible cases for $C_2(z)$ instances: Case (A) on the left, where level 2 does not exist; and case (B) on the right, where level 3 exists.

- the restriction of being non-empty.

In contrast to the relaxed case of $R_{2,1}(z)$ we need to distinguish whether level 2 exists or not, compare Figure 58. The different behaviors of single pointers and (double) cherry pointers are responsible for these two cases.

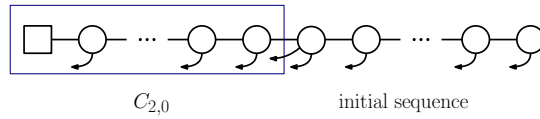

Figure 59: The new initial condition $\hat{C}_{2,0}(z)$. In case (A) the initial sequence cannot be empty, whereas in case (B) it may.

- (A) Let $C_{2,1,A}(z)$ be the generating function of this case. In this case level 2 does not exist (i.e. the tree is part of $C_1(z)$). Then we need to have a cherry on level 1, as this level is not allowed to be empty. This implies that the initial sequence of $\hat{C}_{2,0}(z)$ shown Figure 59 cannot be empty. Then, due to previous reasoning on relaxed trees (compare Proposition 8.4.1), and results on $C_1(z)$ trees (compare Corollary 8.5.2) we get the new initial condition of case (A):

$$\hat{C}_{2,0,A}(z) := \frac{1}{1-z} K(C_{2,0}(z)) = \frac{z(zC_{2,0}(z))' - \int zC_{2,0}'(z) dz}{1-z}.$$

This implies

$$\begin{aligned} C_{2,1,A}(z) &= A(C_{2,0,A}(z)) := \frac{1}{1-z} \int \hat{C}_{2,0,A}(z) dz \\ &= \frac{1}{1-z} \int \frac{1}{1-z} K(C_{2,0,A}(z)) dz. \end{aligned}$$

The first factor $\frac{1}{1-z}$ corresponds to the initial sequence on level 0, and the integral generates the level 0 node of the distinguished right-edge. In anticipation of the subsequent result, we introduced the operator $A(\cdot)$.

- (B) Let $C_{2,1,B}(z)$ be the generating function of this case. In this case level 3 exists. Then, the initial sequence of $\hat{C}_{2,0}(z)$ is allowed to be empty, compare Figure 59. This means that no cherry was lost during the transformation into an instance of $C_1(z)$ as there

is just one pointer pointing into $C_{2,0}(z)$. Such a case is modeled by $(zC_{2,0}(z))'$. Combining it with the case of a non-empty sequence we get the new initial condition of case (B):

$$\begin{aligned} \hat{C}_{2,0,B}(z) &:= (zC_{2,0}(z))' + \frac{1}{1-z}K(C_{2,0}(z)) \\ &= \frac{(zC_{2,0}(z))' - \int zC'_{2,0}(z) dz}{1-z}. \end{aligned}$$

The only difference to case (A) is the lack of the factor z in front of $(zC_{2,0}(z))'$.

By assumption we have nodes on level 2. This means that after the transformation into an instance of $C_1(z)$ we have nodes on level 1. Let $\bar{C}_1(z)$ be the exponential generating function of compacted trees of right-height at most 1 with at least one node on level 1:

$$\bar{C}_1(z) = \sum_{\ell \geq 1} C_{1,\ell}(z) = C_1(z) - C_{1,0}(z).$$

We will continue to work in terms of operators. These are new operators, which fulfill the same tasks as the ones from Theorem 8.4.7 for relaxed trees. From (177) we get

$$M_1(F) := (1 - 2z)F'' - (3 - z)F', \tag{178}$$

$$H_1(F) := \left((1 - z) \left((1 - z)F \right)' \right)', \tag{179}$$

such that $C_1(z)$ satisfies $M_1(C_1(z)) = H_1(C_0(z))$. Thus, for $\bar{C}_1(z)$ we get the following differential equation:

$$M_1(\bar{C}_1(z)) = M_1(C_1(z) - C_{1,0}(z)) = H_1(C_{1,0}(z)) - M_1(C_{1,0}(z)).$$

Then, the differential equation for $C_{2,1,B}(z)$ is given by

$$\begin{aligned} \bar{D}_2(C_{2,1,B}(z)) &:= M_1 \left(\left((1 - z)C_{2,1,B}(z) \right)' \right) \\ &= H_1(\hat{C}_{2,0,B}(z)) - M_1(\hat{C}_{2,0,B}(z)) =: \bar{H}_2(C_{2,0}(z)), \end{aligned}$$

because we are able to reuse the differential equation (177), with the new initial condition $\hat{C}_{2,0,B}(z)$. By Proposition 8.4.4 its solution is equal to $\left((1 - z)C_{2,1,B}(z) \right)'$. The new differential operator is thus given by

$$\bar{D}_2(F) = (2z^2 - 3z + 1)F''' - (z^2 - 10z + 6)F'' - (2z - 6)F'.$$

This process can now be continued recursively, compare Corollary 8.4.5. In order to derive $C_{2,2}(z)$ we exchange $C_{2,0}(z)$ by $C_{2,1}(z)$, and so on. □

Using the last result we are able to characterize compacted trees of right-height at most 2.

Theorem 8.5.5. *The exponential generating function of compacted trees of right-height at most 2 is D -finite and satisfies*

$$(z^2 - 3z + 1)C_2'''(z) - (z^2 - 6z + 6)C_2''(z) - (2z - 3)C_2'(z) = 0,$$

$$C_2(0) = 1, C_2'(0) = 1, C_2''(0) = 3.$$

Proof. The generating function $C_2(z)$ is decomposed into three parts:

$$C_2(z) = C_{2,0}(z) + C_{2,A}(z) + C_{2,B}(z),$$

where $C_{2,A}(z) = \sum_{\ell \geq 0} C_{2,\ell,A}(z)$, $C_{2,B}(z) = \sum_{\ell \geq 0} C_{2,\ell,B}(z)$, and the initial values $C_{2,0,A}(z) = C_{2,0,B}(z) = 0$. Summing the results of Proposition 8.5.4 for $\ell \geq 1$ gives

$$C_{2,A}(z) = A(C_2(z)),$$

$$\bar{D}_2(C_{2,B}(z)) = \bar{H}_2(C_2(z)).$$

Finally, we get

$$\begin{aligned} \bar{D}_2(C_2) &= \bar{D}_2(C_{2,0} + C_{2,A} + C_{2,B}) \\ &= \bar{D}_2(C_{2,0}) + \bar{D}_2(A(C_2)) + \bar{H}_2(C_2), \end{aligned}$$

which gives the new differential operator $M_2(\cdot)$ and its inhomogeneous part $H_2(\cdot)$:

$$M_2(C_2) := \bar{D}_2(C_2) - \bar{D}_2(A(C_2)) - \bar{H}_2(C_2) = \bar{D}_2(C_{2,0}) =: H_2(C_{2,0}).$$

Note that like Equation (165) in the relaxed case we have

$$H_2(F) = M_1(((1-z)F)').$$

For the computation of $M_2(C_2)$ we used Maple. □

The first few differential equations computed by Maple are

$$(1 - 2z) \frac{d^2}{dz^2} C_1(z) + (z - 3) \frac{d}{dz} C_1(z) = 0,$$

$$(z^2 - 3z + 1) \frac{d^3}{dz^3} C_2(z) - (z^2 - 6z + 6) \frac{d^2}{dz^2} C_2(z) - (2z - 3) \frac{d}{dz} C_2(z) = 0,$$

$$(3z^2 - 4z + 1) \frac{d^4}{dz^4} C_3(z) - (4z^2 - 18z + 10) \frac{d^3}{dz^3} C_3(z)$$

$$+ (z^2 - 12z + 14) \frac{d^2}{dz^2} C_3(z) + (z - 3) \frac{d}{dz} C_3(z) = 0.$$

Theorem 8.5.6 (Properties of M_k). *The operator $M_k(\cdot)$ is a linear differential operator of order $k + 1$. It decomposes into*

$$M_k = m_{k,k}(z)D^{k+1} + m_{k,k-1}(z)D^k + \dots + m_{k,0}(z)D + m_{k,-1}(z),$$

where the $m_{k,i}(z)$ are polynomials given by the following recurrence relation for $k \geq 2$

$$\begin{aligned}
 m_{k,-1}(z) &= 0, \\
 m_{k,0}(z) &= \begin{cases} -2z + 3, & \text{for } k \text{ even,} \\ z - 3, & \text{for } k \text{ odd,} \end{cases} \\
 m_{k,i}(z) &= m_{k-1,i-1}(z) + (i+1)m_{k-2,i}(z) \\
 &\quad + (z-i-2)m_{k-2,i-1}(z) - zm_{k-2,i-2}(z), \quad 1 \leq i \leq k-1, \\
 m_{k,k}(z) &= m_{k-1,k-1}(z) - zm_{k-2,k-2}(z), \\
 m_{k,i}(z) &= 0, \quad i > k.
 \end{aligned}$$

The initial polynomials are $m_{0,-1}(z) = -1$, $m_{0,0} = 1 - z$, $m_{1,-1} = 0$, $m_{1,0} = z - 3$, and $m_{1,1}(z) = 1 - 2z$. The leading coefficients $m_{k,k}(z)$ are the same as $\ell_{k,k}(z)$ from the relaxed case.

Proof. The proof is analogous to the one of Lemma 8.4.8. We omit the tedious calculations. \square

It may seem artificial to start the second index at -1 . However, this value is equal to 0 except when $k = 0$. Thus, we are actually dealing with a differential equation of order k in $F'(z)$. Another advantage is that the leading polynomial $m_{k,k}(z)$, which is the same as the one in the relaxed case $\ell_{k,k}(z)$, has the same indices. This will also help us to simplify the subsequent analysis, as the most important part is to find the roots of the leading polynomial. We can simply reuse the results from Lemmas 8.4.13 and 8.4.14, as well as Propositions 8.4.15 and 8.4.16.

First, we need to reveal the structure of the indicial polynomial. Like in the relaxed case none of the other polynomials will have a root at ρ_k .

Lemma 8.5.7. *Let ρ_k be the smallest real root of $m_{k,k}(z)$. Then, the polynomials $m_{k,i}(z)$ for $0 \leq i \leq k-1$ have no root in the interval $[0, \rho_k]$.*

Proof. We apply the same techniques as were used in the proof of Lemma 8.4.20. In particular, we want to show the stronger claim that

$$\begin{cases} m_{k,i}(z) > 0, & \text{for } k-i \text{ even,} \\ m_{k,i}(z) < 0, & \text{for } k-i \text{ odd.} \end{cases}$$

The key idea is an inductive proof. The main observation is that the recurrence relation for $m_{k,i}(z)$ is just a perturbed version of the one for $\ell_{k,i}(z)$. Let us analyze the parity of the involved polynomials:

$$\begin{aligned}
 m_{k,i}(z) &= \underbrace{m_{k-1,i-1}(z)}_{k-i \pmod 2} + (i+1) \underbrace{m_{k-2,i}(z)}_{k-i \pmod 2} \\
 &\quad + (z-i-2) \underbrace{m_{k-2,i-1}(z)}_{k-i-1 \pmod 2} - z \underbrace{m_{k-2,i-2}(z)}_{k-i \pmod 2}.
 \end{aligned}$$

Observe that on the interval $[0, \rho_k]$ the coefficient $(z - i - 2)$ is negative. Thus, by the induction hypothesis the first three terms are of the correct parity. The third term is the same one as in the case of relaxed trees. Therefore, the structure is the same. Only the perturbation, which is not influencing the result, changed. We have

$$m_{k,i}(z) = m_{k-1,i-1}(z) - zm_{k-2,i-2}(z) + \tilde{h}(z),$$

where $\tilde{h}(z)$ contains the neglected polynomials. Yet the remaining part is the same as in the previous case. \square

This implies that only the first two summands will contribute to the indicial polynomial. In order to compute the value $\delta_1 = \lim_{z \rightarrow \zeta} (z - \zeta)a_1(z)$ (compare the differential equation (167)) we need the following result on $m_{k,k-1}(z)$.

Lemma 8.5.8 (Bivariate generating function of $m_{k,k-1}(z)$). *Let the function $M(x, z) = \sum_{n,k \geq 0} m_{k,k-1}(z)x^k$ be the bivariate generating function of $m_{k,k-1}(z)$ of the M_k operators. Then,*

$$M(x, z) = -\frac{1 - xz - x^2z^2 - 2x^3z^3 + x^4z^3}{(1 - x + zx^2)^3}. \quad (180)$$

Proof. This result is simply a reformulation of the defining recurrence relation of $m_{k,k-1}(z)$ combined with the result on the generating function of $m_{k,k}(z)$ from Lemma 8.4.13. \square

Before we continue, we need to analyze the polynomial $m_{k,k-1}(z)$. We derive three different expressions for it in the next Lemma: a ‘‘Catalan-expansion’’, an expansion at $z = 1/4$, and an expansion at $z = 0$.

Lemma 8.5.9. *Let $B(z) = \frac{1 - \sqrt{1-4z}}{2}$ be the generating function of the Catalan numbers, and $\bar{B}(z) = \frac{1 + \sqrt{1-4z}}{2}$. Then,*

$$\begin{aligned} m_{k,k-1}(z) &= \frac{1}{(1-4z)^{3/2}} \left(\frac{k^2 + 5k + 4 - 2z(k-1)}{2} (\bar{B}(z)^{k+2} - B(z)^{k+2}) \right. \\ &\quad \left. - (k^2 + 4k + 3 - 2kz) (\bar{B}(z)^{k+3} - B(z)^{k+3}) \right) \\ &= -\frac{1}{2^{k+2}} \sum_{i=0}^{\lfloor \frac{k+2}{2} \rfloor} (1-4z)^i \left(\frac{k}{2} \binom{k+2}{2i} + \frac{1}{2} \binom{k+2}{2i+1} \right) \\ &\quad + \left(k^2 + \frac{7k}{2} + 3 \right) \binom{k+2}{2i+2} - \left(k + \frac{3}{2} \right) \binom{k+2}{2i+3} \\ &= -\binom{k+2}{2} + \sum_{n=1}^{\lfloor \frac{k+2}{2} \rfloor} \frac{(-1)^{n+1} z^n}{2n} \binom{k-n+1}{n-1} (k^3 - (4n-5)k^2 \\ &\quad + 4(n-1)(n-2)k + 2(n-1)(3n-2)). \end{aligned} \quad (181)$$

Proof. The roots of the denominator of (180) with respect of x are given by $B(z)$ and $\bar{B}(z)$. A partial fraction decomposition gives then first result, and extraction of the coefficients yields the result. The second expression is a simplification of the first one, by an expansion of $(1 \pm x)^i$ with $x = \sqrt{1-4z}$ and a proper reordering. The third result can be directly checked to be valid with the recurrence relation. (It was found via a guess-and-prove approach, built on the sequences of the coefficients of powers of z .) \square

Before we proceed we want to point out that the first expression for $m_{k,k-1}(z)$ is only valid for $|z| < \frac{1}{4}$. The second one however is a polynomial in z and thus analytic in the complete complex plane. It is the analytic expansion of the first one.

As a next step we will compute the indicial polynomial of compacted trees. However, first we need to strengthen the results on ρ_k from Proposition 8.4.16.

Corollary 8.5.10. *The smallest real root ρ_k of $m_{k,k}(z)$ satisfies for $k \rightarrow \infty$ the following expansion*

$$\rho_k = \frac{1}{4} \left(1 + \frac{\pi^2}{k^2} - \frac{6\pi^2}{k^3} + \frac{2\pi^4 + 81\pi^2}{3k^4} - \frac{97\pi^4 + 1288\pi^2}{12k^5} + \mathcal{O}\left(\frac{1}{k^6}\right) \right).$$

Proof. From Proposition 8.4.16 we know that $\rho_k = \frac{1}{4}(1 + \frac{c}{k^2})$, for $9 < c < 10$. Inserting this value into (174) we get

$$0 = \sum_{i=0}^{\lfloor \frac{k+2}{2} \rfloor} \frac{(-c)^i}{(2i+1)!} \frac{(k+3)_{2i+1}}{k^{2i}},$$

with the falling factorial $(k+3)_{2i+1} = \prod_{j=0}^{2i} (k+3-j)$. Next, we expand the last factor for $k \rightarrow \infty$. This gives

$$\frac{(k+3)_{2i+1}}{k^{2i}} = k - (2i-1)(i-3) + \mathcal{O}\left(\frac{1}{k}\right). \tag{182}$$

As the monomials k^{-i} form a basis we may split the initial sum into multiple sums. Additionally, note that the error from changing the upper bound to ∞ is of order $\mathcal{O}(k^{-k})$. Thus, as $c > 0$ we get for large k that

$$0 = k \sum_{i=0}^{\infty} (-1)^i \frac{c^i}{(2i+1)!} + \mathcal{O}(1) = k \frac{\sin(\sqrt{c})}{\sqrt{c}} + \mathcal{O}(1).$$

This implies, together with $9 < c < 10$ that $c = \pi^2$. Continuing this ansatz with higher order terms one can use a computer algebra system to get the given expansion. \square

Proposition 8.5.11. *Let $I_k(\alpha) = \alpha^{k+1} + \delta_1 \alpha^k + \dots + \delta_{k+1}$ be the indicial polynomial of the k -th differential equation, and let ρ_k be the smallest real*

root of $m_{k,k}(z)$. Then, we have $\delta_i = 0$ for $i > 1$, and $\delta_1 = \frac{m_{k,k-1}(\rho_k)}{m'_{k,k}(\rho_k)}$. Furthermore, we have

$$\delta_1 = \frac{k}{2} + \frac{3}{4} - \frac{\pi^2}{4k^2} + \mathcal{O}\left(\frac{1}{k^3}\right).$$

The indicial polynomial is given by $I_k(\alpha) = \alpha^k(\alpha - (k - \delta_1))$.

Proof. The first results are analogous to the ones in Proposition 8.4.21: First, due to Lemma 8.5.7 we have $\delta_i = 0$ for $i > 0$. Second, the expression for δ_1 is the same as in (175), and follows from L'Hospital's rule. Thus, the indicial polynomial is given by $I_k(\alpha) = \alpha^{k+1} + \delta_1 \alpha^k$.

For the expansion of δ_1 we start with Corollary 8.5.10 and use the shorthand $\rho_k = \frac{1}{4}(1 + \frac{c}{k^2})$, where c depends on k . Then, from (174) and (181) we get

$$m'_{k,k}(\rho_k) = -\frac{1}{2^{k+2}} \sum_{i=0}^{\lfloor \frac{k+3}{2} \rfloor} 4(i+1) \frac{(-c)^i}{(2i+3)!} \frac{(k+3)^{2i+3}}{k^{2i}},$$

$$m_{k,k-1}(\rho_k) = -\frac{1}{2^{k+2}} \sum_{i=0}^{\lfloor \frac{k+2}{2} \rfloor} p(i,k) \frac{(-c)^i}{(2i+3)!} \frac{(k+2)^{2i}}{k^{2i}},$$

where $p(i,k) = 2k^4 + \dots$ is a polynomial of degree 4 in i and k . We will now compute several asymptotic expansions. For this purpose we applied the computer algebra system Maple. Firstly, similar to (182) we derive the expansions

$$\frac{(k+3)^{2i+3}}{k^{2i}} = k^3 \left(1 - \frac{(2i+3)(i-2)}{k} + \mathcal{O}\left(\frac{1}{k^2}\right) \right),$$

$$\frac{(k+2)^{2i}}{k^{2i}} = 1 - \frac{i(2i-5)}{k} + \mathcal{O}\left(\frac{1}{k^2}\right).$$

Secondly, combining these results, and splitting the series with respect to k we are able to find closed-form expressions for the summations with respect to i (recall that $c > 0$). In particular, this gives

$$2^{k+2}m'_{k,k}(\rho_k) = -2k^3 \left(\frac{\cos(\sqrt{c})}{c} - \frac{\sin(\sqrt{c})}{\sqrt{c^3}} \right) + \mathcal{O}(k^2),$$

$$2^{k+2}m_{k,k-1}(\rho_k) = -k^4 \left(\frac{\cos(\sqrt{c})}{c} - \frac{\sin(\sqrt{c})}{\sqrt{c^3}} \right) + \mathcal{O}(k^3).$$

Finally, we get $\delta_1 = \frac{k}{2} + \mathcal{O}(1)$. Redoing the same computations with more error terms and using the expansion of $c = \pi^2 + \mathcal{O}(k^{-1})$ with sufficiently many terms shows the claim. \square

Theorem 8.5.12 (Asymptotics of compacted binary trees with bounded right-height). *The number $c_{k,n}$ of compacted trees with right-height at most k is asymptotically equal to*

$$c_{k,n} \sim \gamma_k n! n^{\delta_1 - k - 1} \rho_k^{-n} = o\left(n! n^{-k/2 - 1/4} \rho_k^{-n}\right),$$

where $\gamma_k \in \mathbb{R}$ is a constant, $\rho_k \in (\frac{1}{4}, \frac{1}{4}(1 + \frac{10}{k^2}))$ is the root of $m_{k,k}(z)$, and $\delta_1 = \frac{m_{k,k-1}(\rho_k)}{m'_{k,k}(\rho_k)}$.

In contrast to relaxed trees, the asymptotic of compacted trees involves in general an irrational critical exponent. In Table 20 we list their first explicit values.

k	ρ_k	$\rho_k \approx$	α	$\alpha \approx$	β	$\beta \approx$
1	$\frac{1}{2}$	0.500	$-\frac{3}{4}$	-0.750	$-\frac{1}{2}$	-0.5
2	$\frac{3}{2} - \frac{\sqrt{5}}{2}$	0.382	$-\frac{3}{2} + \frac{\sqrt{5}}{10}$	-1.276	-1	-1.0
3	$\frac{1}{3}$	0.333	$-\frac{16}{9}$	-1.778	$-\frac{3}{2}$	-1.5
4	ρ_4	0.308	$49\alpha^3 + 441\alpha^2 + 1260\alpha + 1161 = 0$	-2.275	-2	-2.0
5	$1 - \frac{\sqrt{2}}{2}$	0.293	$-\frac{25}{8} + \frac{\sqrt{2}}{4}$	-2.772	$-\frac{5}{2}$	-2.5
6	ρ_6	0.283	$243\alpha^3 + 3483\alpha^2 + 15066\alpha + 20519 = 0$	-3.268	-3	-3.0
7	$\frac{1}{2} - \frac{\sqrt{5}}{10}$	0.276	$-\frac{39}{10} + \frac{3\sqrt{5}}{50}$	-3.766	$-\frac{7}{2}$	-3.5

Table 20: The number $c_{k,n}$ ($r_{k,n}$) of compacted (relaxed) trees with n internal nodes and right-height at most k is asymptotically equal to $\kappa_k n! \rho_k^n n^\alpha$ ($\gamma_k n! \rho_k^n n^\beta$). The missing radii of convergence are $\rho_4 = 2 - \sqrt{7} \sin\left(\frac{1}{3} \arctan\left(\frac{\sqrt{3}}{9}\right)\right) - \frac{\sqrt{21}}{3} \cos\left(\frac{1}{3} \arctan\left(\frac{\sqrt{3}}{9}\right)\right)$, and $\rho_6 = 3 - \sqrt{21} \sin\left(\frac{1}{3} \arctan\left(\frac{\sqrt{3}}{37}\right)\right) - \sqrt{7} \cos\left(\frac{1}{3} \arctan\left(\frac{\sqrt{3}}{37}\right)\right)$.

We can finally answer the question (at least asymptotically) of how many relaxed trees are actually compacted trees. Combining Theorems 8.4.23 and 8.5.12 we get the following result.

Corollary 8.5.13 (Ratio of compacted among relaxed trees). *Let $c_{k,n}$ ($r_{k,n}$) be the number of compacted (relaxed) binary trees with right-height at most k . Then, for $n \rightarrow \infty$ we have*

$$\frac{c_{k,n}}{r_{k,n}} \sim \kappa n^{\delta_1 - \frac{k}{2} - 1} = \kappa n^{-\frac{1}{4} \left(1 + \frac{\pi^2}{k^2} + \mathcal{O}\left(\frac{1}{k^3}\right)\right)} = o\left(n^{-1/4}\right).$$

Thus, the number of compacted trees among relaxed trees for large n is negligible. This result quantifies the restriction of uniqueness of subtrees in the compacted trees.

8.6 CONNECTIONS WITH CHEBYSHEV POLYNOMIALS

This section was added after this thesis had been submitted to the referees. In order not to alter the structure of the previous version, it was put at the end of the chapter. In here we present connections of the $\ell_{k,i}(z)$ and $m_{k,i}(z)$ polynomials from Theorems 8.4.8 and 8.5.6 with Chebyshev polynomials. This explains the nice results of the technical

lemmas needed to derive the asymptotics of relaxed and compacted binary trees.

Let us start with the definitions of *Chebyshev polynomials* of the first and second kind, see [61, Chapter 18] or [2, Chapter 22].

Definition 8.6.1 (Chebyshev polynomials). *The Chebyshev polynomials of the first kind $T_n(z)$ are defined by the recurrence relation*

$$\begin{aligned} T_0(z) &= 1, \\ T_1(z) &= z, \\ T_{n+2}(z) &= 2zT_{n+1}(z) - T_n(z). \end{aligned}$$

The Chebyshev polynomials of the second kind $U_n(z)$ are defined by the recurrence relation

$$\begin{aligned} U_0(z) &= 1, \\ U_1(z) &= 2z, \\ U_{n+2}(z) &= 2zU_{n+1}(z) - U_n(z). \end{aligned}$$

Relaxed binary trees

The first result gives a closed-form expression of the leading coefficients $\ell_{k,k}(z)$ (and $m_{k,k}(z)$).

Lemma 8.6.2 (Transformed leading coefficient). *Let $\ell_{k,i}(z)$ be the coefficients of the operator L_k from Theorem 8.4.8. Then, for the leading coefficient we get*

$$\ell_{k,k}(z) = z^{\frac{k+2}{2}} U_{k+2} \left(\frac{1}{2\sqrt{z}} \right) = \sum_{n=0}^{\lfloor \frac{k+2}{2} \rfloor} (-1)^n \binom{k+2-n}{n} z^n,$$

where $T_k(z)$ and $U_k(z)$ are the Chebyshev polynomials of first and second kind, respectively.

Proof. Let us start with the recurrence relation of $\ell_{k,k}(z)$ from Theorem 8.4.8. Replacing z by $\frac{1}{4z^2}$ and multiplying by $(2z)^{k+2}$ we get

$$(2z)^{k+2} \ell_{k,k} \left(\frac{1}{4z^2} \right) = 2z \cdot (2z)^{k+1} \ell_{k-1,k-1} \left(\frac{1}{4z^2} \right) - (2z)^k \ell_{k-2,k-2} \left(\frac{1}{4z^2} \right),$$

and we recognize the recurrence relation for the Chebyshev polynomials of the second kind for $(2z)^k \ell_{k-2,k-2} \left(\frac{1}{4z^2} \right)$, compare [61, Section 18.9]. Transforming the initial conditions, gives $U_2(z)$ and $U_3(z)$, respectively.

The closed-form is derived from $U_k(z) = \sum_{n=0}^{\lfloor \frac{k}{2} \rfloor} (-1)^n \binom{k-n}{n} z^n$. \square

Chebyshev polynomials are well-studied objects. We summarize the implied results in the following lemma. It implies the results of Propositions 8.4.15 and 8.4.16, Corollaries 8.4.18 and 8.5.10, and partly the ones of Lemma 8.4.20.

Lemma 8.6.3. *The roots of $\ell_{k,k}(z)$ are real, positive, and distinct. Let ρ_k be the smallest real root of $\ell_{k,k}(z)$. Then, we have*

$$\rho_k = \frac{1}{4 \cos^2 \left(\frac{\pi}{k+3} \right)}.$$

Furthermore, ρ_k is no root of $\ell_{k,k-1}(z)$.

Proof. The results follow from the well-known results on Chebyshev polynomials [61, Section 18.5]. In particular, the roots $x_{k,j}$ of $U_k(z)$ admit the closed-form expressions

$$x_{k,j} = \cos \left(\frac{j\pi}{k+1} \right).$$

This implies the closed-form expression of ρ_k . The last result follows from the closed form expression of $\ell_{k,k-1}(z)$ from Lemma 8.6.2. \square

Compacted binary trees

In order to compute the value $\delta_1 = \lim_{z \rightarrow \zeta} (z - \zeta) a_1(z)$ (compare the differential equation (167)) we need the following result on $m_{k,k-1}(z)$. It makes the results of Lemma 8.5.9 more specific.

Lemma 8.6.4 (Transformed $m_{k,k-1}(z)$). *For the coefficient $m_{k,k-1}(z)$ of the operator M_k from Theorem 8.5.6 we get*

$$m_{k,k-1}(z) = z^{\frac{k+2}{2}} h_{k+2} \left(\frac{1}{2\sqrt{z}} \right),$$

where

$$h_k(z) = \frac{(k-3-2(k^2+k-2)z^2) T_k(z) + (1+2(k-1)z^2) U_k(z)}{2(z^2-1)},$$

and $T_k(z)$ and $U_k(z)$ are the Chebyshev polynomials of first and second kind, respectively.

Proof. From Theorem 8.5.6 we get the recurrence relation of $m_{k,k-1}(z)$:

$$m_{k,k-1}(z) = m_{k-1,k-2}(z) - z m_{k-2,k-3}(z) + (z-k-1) m_{k-2,k-2}(z).$$

Its structure is similar to the one of $m_{k,k}(z)$, but with an additional perturbation $(z-k-1) m_{k-2,k-2}(z)$. Transforming it in the same way as the one of $m_{k,k}(z)$ we get with

$$h_{k+2}(z) := (2z)^{k+2} m_{k,k-1} \left(\frac{1}{4z^2} \right),$$

for $k \geq 0$ the recurrence

$$h_{k+2}(z) = 2z h_{k+1}(z) - h_k(z) + (1 - 4z^2(k+1)) U_k(z).$$

From the theory of recurrences with constant coefficients (with respect to k) [122, Chapter 4] we get that the solution space is generated by $U_k(z), T_k(z), kU_k(z), kT_k(z), k^2U_k(z), k^2T_k(z)$. Making an ansatz and comparing coefficients gives the result. \square

The following result gives a closed-form of the expansion derived in Proposition 8.5.11.

Proposition 8.6.5. *Let $I_k(\alpha) = \alpha^{k+1} + \delta_1 \alpha^k + \dots + \delta_{k+1}$ be the indicial polynomial of the k -th differential equation, and let ρ_k be the smallest real root of $m_{k,k}(z)$. Then, we have $\delta_i = 0$ for $i > 1$, and $\delta_1 = \frac{m_{k,k-1}(\rho_k)}{m'_{k,k}(\rho_k)}$. Furthermore, we have*

$$\delta_1 = \frac{k}{2} + 1 - \frac{1}{k+3} - \left(\frac{1}{4} - \frac{1}{k+3} \right) \frac{1}{\cos^2\left(\frac{\pi}{k+3}\right)}.$$

The indicial polynomial is given by $I_k(\alpha) = \alpha^k(\alpha - (k - \delta_1))$.

Proof. The first results are the same as the ones of Proposition 8.5.11. It remains to prove the closed-form of δ_1 .

We start with two simplifications for the root $x_k = \cos^2\left(\frac{\pi}{k+1}\right)$ of $U_k(z)$ when inserted into $T_k(z)$. By the explicit expression $T_k(z) = \cos(k \arccos(z))$, for $|z| \leq 1$, we get

$$T_k(x_k) = -\cos\left(\frac{\pi}{k+1}\right) = -x_k, \quad \text{and} \quad T_{k+1}(x_k) = -1.$$

First, we consider $m_{k,k-1}(z)$. By Lemma 8.6.4 we directly get

$$m_{k,k-1}(\rho_k) = \rho_k^{\frac{k+2}{2}} \frac{(k-1)x_{k+2} - 2((k+2)^2 + k)x_{k+2}^3}{2(x_{k+2}^2 - 1)},$$

where $\rho_k = \frac{1}{4x_{k+2}}$, and recall that $U_k(x_k) = 0$.

Second, we consider the derivative of $m_{k,k}(z)$. Therefore, we use the following connection of Chebyshev polynomials of the first and second kind, see [61, Section 18.9]:

$$U'_k(z) = \frac{(k+1)T_{k+1}(z) - zU_k(z)}{z^2 - 1}.$$

Thus, we get by Lemma 8.6.2 that

$$m'_{k,k}(\rho_k) = \frac{\rho_k^{\frac{k-1}{2}}}{4} \frac{k+3}{x_{k+2}^2 - 1}.$$

Combining these results shows the claim. \square

With these results we are able to refine our main result on compacted binary trees, Theorem 8.5.12.

Theorem 8.6.6 (Refined asymptotics of compacted binary trees with bounded right-height). *The number $c_{k,n}$ of compacted trees with right-height at most k is asymptotically equal to*

$$c_{k,n} \sim \kappa_k n! \left(4 \cos\left(\frac{\pi}{k+3}\right) \right)^n n^{-\frac{k}{2} - \frac{1}{k+3} - \left(\frac{1}{4} - \frac{1}{k+3}\right) \frac{1}{\cos^2\left(\frac{\pi}{k+3}\right)}},$$

where $\kappa_k \in \mathbb{R}$ is independent of n .

Proof. The proof follows the same lines as the one of Theorem 8.4.23. In particular, the third case of Theorem 8.4.12 gives the asymptotic result, as δ_1 is irrational for all $k \in \mathbb{N}$. \square

In contrast to relaxed trees, the asymptotics of compacted trees involves in general an irrational critical exponent. In Table 21 we list their first explicit values. It replaces Table 20.

k	r	$r \approx$	α	$\alpha \approx$	β	$\beta \approx$
1	2	2.000	$-\frac{3}{4}$	-0.750	$-\frac{1}{2}$	-0.5
2	$4 \cos(\frac{\pi}{5})^2$	2.618	$-\frac{6}{5} - \frac{1}{20 \cos(\frac{\pi}{5})^2}$	-1.276	-1	-1.0
3	3	3.000	$-\frac{16}{9}$	-1.778	$-\frac{3}{2}$	-1.5
4	$4 \cos(\frac{\pi}{7})^2$	3.246	$-\frac{15}{7} - \frac{3}{28 \cos(\frac{\pi}{7})^2}$	-2.275	-2	-2.0
5	$4 \cos(\frac{\pi}{8})^2$	3.414	$-\frac{21}{8} - \frac{1}{8 \cos(\frac{\pi}{8})^2}$	-2.772	$-\frac{5}{2}$	-2.5
6	$4 \cos(\frac{\pi}{9})^2$	3.532	$-\frac{28}{9} - \frac{5}{36 \cos(\frac{\pi}{9})^2}$	-3.268	-3	-3.0
7	$4 \cos(\frac{\pi}{10})^2$	3.618	$-\frac{18}{5} - \frac{3}{20 \cos(\frac{\pi}{10})^2}$	-3.766	$-\frac{7}{2}$	-3.5

Table 21: The number $c_{k,n}$ ($r_{k,n}$) of compacted (relaxed) trees with n internal nodes and right-height at most k is asymptotically equal to $\kappa_k n! r^n n^\alpha$ ($\gamma_k n! r^n n^\beta$) with $r = \rho_k^{-1}$.

Furthermore, we get the following more specific result on the ratio of compacted trees among relaxed trees. This refines Corollary 8.5.13.

Corollary 8.6.7 (Refined ratio of compacted among relaxed trees). *Let $c_{k,n}$ ($r_{k,n}$) be the number of compacted (relaxed) binary trees with right-height at most k . Then, for $n \rightarrow \infty$ we have*

$$\frac{c_{k,n}}{r_{k,n}} \sim \frac{\kappa_k}{\gamma_k} n^{-\frac{1}{k+3} - (\frac{1}{4} - \frac{1}{k+3}) \frac{1}{\cos^2(\frac{\pi}{k+3})}} = o(n^{-1/4}).$$

8.7 CONCLUSION

In this chapter we solved the (asymptotic) counting problem of compacted and relaxed binary trees of bounded right-height. In a compacted binary tree every subtree is unique, and repeatedly occurring subtrees have been deleted and replaced by pointers to the first appearance. By doing so, the tree structure is destroyed and we end up with a directed acyclic graph (DAG). In a relaxed binary tree the uniqueness condition of subtrees is dropped.

The construction also already explains the difficulty of this counting problem: a compacted binary tree of size n arises from a binary

tree of size n as well as from a binary tree of size 2^n . Our main results are recurrence relations for compacted and relaxed binary trees in Theorem 8.2.1 and Corollary 8.2.3, respectively.

Due to their super-exponential growth of order $\mathcal{O}(n!4^n)$ exponential generating functions are the natural choice. Our second main contribution is the derivation of a calculus on such exponential generating functions modeling the structural properties of compacted trees in Section 8.3.

Resulting from these ideas, we were able to give our last main result: the derivation of ordinary differential equations for relaxed and compacted binary trees of bounded right-height. The right-height of a tree is the maximal number of right edges from the root to any leaf. Furthermore, we extracted the asymptotics by extending the theory of coefficient extractions of ordinary differential equations with polynomial coefficients in Theorem 8.4.12. This yielded the sought asymptotics in Theorems 8.4.23 and 8.5.12.

This gives quite “exotic” families of trees. The radii of convergence are in both cases algebraic numbers, and in the case of compacted trees, also the critical exponents are (compare Table 20 or Table 21 for the first 7 families).

It remains an open problem to find the asymptotics of relaxed and compacted trees without any restrictions. For our methods it was crucial that the right-height was bounded by a fixed value k . The limit $k \rightarrow \infty$ is therefore not computable. Note that we showed that the radius of convergence ρ_k converges to $1/4$. But the subexponential growth is of the shape $n^{-\lambda k}$ for $\lambda > 0$. Thus, it would converge to 0. Hence, the limits $n \rightarrow \infty$ and $k \rightarrow \infty$ are not interchangeable.

Finally, it was interesting to compare the number of compacted trees among relaxed trees in Corollary 8.5.13. We showed that their number is negligible for large n .

Many new questions arise after this analysis. It would be interesting to consider parameters such as their average height or right-height. Furthermore, these results give us the generating functions of a large family of DAGs which should allow us to do a uniform random sampling of these trees. Such results are interesting in computer science and the analysis of algorithms, as DAGs are efficient data structures and widely-used. Among other things, new algorithms need to be tested on very large and non-trivial elements of an efficiently computable class.

Part IV

APPLICATIONS TO NUMBER THEORY

This part deals with applications of analytic combinatorics to number theory. It considers the exact divisibility of the rows of Pascal's triangle by powers of primes p^j . Building on recent results it can be expressed by polynomials in variables counting the occurrences of certain blocks of patterns in the base- p expansion of the row. We express these polynomials using generating functions and show uniqueness and existence. Finally, singularity analysis gives us access to certain bounds.

DIVISIBILITY OF BINOMIAL COEFFICIENTS BY
 POWERS OF PRIMES

This chapter is based on joint work with Lukas Spiegelhofer. A manuscript has recently been submitted to a journal and a preprint can be found on arxiv.org [172].

The history of binomial coefficients in congruence classes modulo m begins not later than in the middle of the 19th century, when Kummer [132] stated his famous theorem on the highest power m of a prime p dividing a binomial coefficient $\binom{n}{t}$: m is the number of borrows occurring in the subtraction $n - t$ in base p . In other words, this is the number of indices k such that $n \bmod p^k < t \bmod p^k$. Kummer's theorem was generalised to multinomial and q -multinomial coefficients by Fray [89], and to generalised binomial coefficients by Knuth and Wilf [128].

A complete list of results related to Pascal's triangle modulo powers of primes would go beyond the scope of any research paper; we refer the reader to the surveys [102, 168] by Granville and Singmaster respectively for an overview of the topic. The question also attracts other areas of research: in [7, Section 14.6] and [5], connections with automatic sequences and combinatorics on words are highlighted. Moreover, the paper [8] considers the related question of counting coefficients equal to a given value of a polynomial over a finite field.

In this chapter we restrict ourselves to questions concerning *exact divisibility* of binomial coefficients by powers of primes. This means that we are only concerned with the residue class p^j modulo p^{j+1} , in other words, we study the case $v_p\binom{n}{t} = j$, where $v_p(m)$ denotes the largest k such that $p^k \mid m$.

We therefore introduce the following notion. Let j and n be non-negative integers and p a prime number, and define

$$\vartheta_p(j, n) = \left| \left\{ t \in \{0, \dots, n\} : v_p\binom{n}{t} = j \right\} \right|. \quad (183)$$

Put into words, $\vartheta_p(j, n)$ is the number of entries in the n -th row of Pascal's triangle that are exactly divisible by p^j . The case $j = 0$ can be reduced to properties of the base- p expansion of the row number n by appealing to Lucas' congruence [139]. This well-known congruence asserts that for $t \leq n$ having the (not necessarily proper) base- p representations $n = (n_{v-1} \cdots n_0)_p$ and $t = (t_{v-1} \cdots t_0)_p$, we have

$$\binom{n}{t} \equiv \binom{n_{v-1}}{t_{v-1}} \cdots \binom{n_0}{t_0} \pmod{p}.$$

Since p is a prime number, we have $p \nmid \binom{n}{i}$ if and only if none of the factors is divisible by p , which in turn is equivalent to $t_i \leq n_i$ for all $i < v$. We obtain, denoting by $|n|_a$ the number of times the digit $a \neq 0$ occurs in the base- p expansion of n ,

$$\vartheta_2(0, n) = 2^{|n|_1} \tag{184}$$

for the case $p = 2$ (Glaisher [98]) and more generally (Fine [82])

$$\vartheta_p(0, n) = \prod_{0 \leq i < v} (n_i + 1) = 2^{|n|_1} 3^{|n|_2} 4^{|n|_3} \dots p^{|n|_{p-1}}. \tag{185}$$

Lucas' congruence has been generalised and extended in different directions, see for example [89], [123] (reproved in [166]), [58, 101, 102]; moreover [60] for an account of less recent results. In order to be able to formulate our results concerning general $j \geq 0$, we need some notation.

Notation. The letter p always denotes a prime number; we use type-writer font to indicate digits in the base- p expansion, except for variables representing digits. For the $(p - 1)$ -st digit we write q , a letter supposed to be a mnemonic relating to 9 in the decimal expansion. If v is an infinite word over the alphabet $\{0, \dots, q\}$ such that $v_i \neq 0$ for only finitely many $i \geq 0$, let $(v)_p = \sum_{i \geq 0} v_i p^i$ be the integer represented by v in base p . Moreover, if $w = (w_{v-1} \dots w_0) \in \{0, \dots, q\}^v$ contains at least one non-zero digit and v is as above, let $|v|_w$ be the number of times that w occurs as a factor of v . More precisely,

$$|v|_w = |\{i \geq 0 : (v_{i+v-1}, \dots, v_i) = (w_{v-1}, \dots, w_0)\}|. \tag{186}$$

For finite words v we extend the above notions by padding with zeros. Moreover, if n is a non-negative integer and $n = (v)_p$, we set $|n|_w := |v|_w$. Occurrences of factors may overlap: for example, for $p = 2$ we have $|42|_{1010} = |101010|_{1010} = 2$. Moreover, as a consequence of the padding with zeros we have $|1|_1 = |1|_{01} = |1|_{001} = \dots = 1$, while $|1|_{10} = 0$.

The following statement is an easy reformulation of [160, Theorem 2]. The method used for proving this theorem is very similar to the method used in the older paper [33, Theorem 5], which proves a less detailed form of the result, but can be adapted to yield the full statement. See also Remark 31.

Theorem 9.0.1 (Rowland [160], Barat–Grabner [33]). *Let p be a prime and $j \geq 0$. Then $\vartheta_p(j, n) / \vartheta_p(0, n)$ is given by a polynomial P_j of degree j in the variables X_w , where w ranges over the set*

$$W_j = \{w \in \{0, \dots, q\}^v : 2 \leq v \leq j + 1, w_{v-1} \neq 0, w_0 \neq q\}, \tag{187}$$

and X_w is set to $|n|_w$.

Note that $W_0 = \emptyset$ and $P_0(x) = 1$. Determining $\vartheta_p(j, n)/\vartheta_p(0, n)$ by means of this theorem is a two-step procedure:

$$n \mapsto (|n|_w)_{w \in W_j} \mapsto P_j\left((|n|_w)_{w \in W_j}\right) = \frac{\vartheta_p(j, n)}{\vartheta_p(0, n)}. \tag{188}$$

Barat and Grabner [33, Theorem 5] used a representation of $\frac{\vartheta_p(j, n)}{\vartheta_p(0, n)}$ of this kind in order to establish an asymptotic formula for the partial sums $\sum_{0 \leq n < N} \vartheta_p(j, n)$. Their Theorem 5 generalises the case $j = 0$ [84] (see also [34, 176]), and yields a quantitative version of the statement “any integer divides almost all binomial coefficients” [167].

Theorem 9.0.1 implies, as noted by Rowland, that the sequence $n \mapsto \vartheta_p(j, n)/\vartheta_p(0, n)$ is p -regular in the sense of Allouche and Shallit [6, 7]. We will however not follow this line of research in this chapter.

In Proposition 9.3.1 we will prove that a polynomial P_j as in Theorem 9.0.1 is uniquely determined, so that we may talk about the coefficients of P_j without ambiguity. These polynomials are the main object of study in this chapter, and want to obtain a better understanding of its coefficients. Our main theorem concerns the behavior of the coefficients of a single monomial in the sequence $(P_j)_{j \geq 0}$ of polynomials.

Theorem 9.0.2. *Let W be the set of all words $(w_{v-1}, \dots, w_0) \in \{0, \dots, q\}^v$ such that $v \geq 2$, $w_{v-1} \neq 0$ and $w_0 \neq q$. Assume that $w^{(1)}, \dots, w^{(\ell)} \in W$, and k_1, \dots, k_ℓ are positive integers. Let c_j be the coefficient of the monomial*

$$X_{w^{(1)}}^{k_1} \cdots X_{w^{(\ell)}}^{k_\ell}$$

in the polynomial P_j . Then

$$\sum_{j \geq 0} c_j x^j = \frac{1}{k_1!} (\log r_{w^{(1)}}(x))^{k_1} \cdots \frac{1}{k_\ell!} (\log r_{w^{(\ell)}}(x))^{k_\ell},$$

where r_w is a rational function defined at 0 such that $r_w(0) = 1$.

The rational function r_w can be determined explicitly by means of a recurrence, see Proposition 9.3.6. The easiest nontrivial example is $r_{10}(x) = 1 + x/2$. Note that the coefficients c_j always belong to a fixed monomial $X_{w^{(1)}}^{k_1} \cdots X_{w^{(\ell)}}^{k_\ell}$. However, in order to increase readability we will not emphasize this relationship by additional sub- or superscripts. It will always be clear from the context which monomial is referred to.

As a direct consequence of our results we will obtain the following corollary.

Corollary 9.0.3. *The coefficient c_j of the monomial X_{10} in P_j is equal to $[x^j] \log(1 + x/2)$. In particular,*

$$\sum_{j \geq 0} c_j = \log(3/2).$$

This special case confirms an observation by Rowland [160], who noted that a plot of the first few partial sums $c'_j = c_0 + \cdots + c_{j-1}$ “suggests that the limit of this sequence exists”. He computed the first seven polynomials

$$P'_j = P_0 + \cdots + P_{j-1}$$

with the help of his Mathematica package `BINOMIALCOEFFICIENTS`, which is based on his paper [160] and available from his website, and determined the coefficients c'_j that way. By the above corollary the limit does exist indeed, and its value is $\log(3/2)$. It is however not true for each monomial M that the sequence of coefficients of M in P'_j converges as $j \rightarrow \infty$, nor is it the case that all coefficients of P'_j are non-negative. A simultaneous counterexample for both questions is given by X_{1010} (see the examples after Corollary 9.4.3). The sequence of coefficients of this monomial has the generating function

$$\log\left(1 + \frac{1}{2}x^3 / (1 + x/2)^2\right),$$

which has a unique dominant singularity $x_0 \sim -0.86408$. Therefore negative signs occur infinitely often and the sequence of coefficients diverges to ∞ in absolute value (this is true for the coefficients in P_j as well as in P'_j).

While the above results concern the behavior of a single monomial in different polynomials P_j , we will also prove an “orthogonal” result, namely an asymptotic estimate of the number of non-zero coefficients in P_j and P'_j (Corollary 9.3.8).

The results that we have outlined above provide answers to questions posed by Rowland [160] at the end of his paper. For more details, we refer to Section 9.2. Finally, we want to note that our main theorem together with the recurrence for r_w enables us to compute the polynomials P_j very efficiently (see Remark 35).

We will also use the following notations in this chapter. The integer $s_2(n) := |n|_1$ is the *sum of digits* of n in base 2, more generally $s_p(n) := |n|_1 + 2|n|_2 + \cdots + (p-1)|n|_q$ is the sum of digits of n in base p . For a finite word w we denote by $|w|$ the length of w . Finally, \mathbb{N} denotes the set of non-negative integers.

Plan of this chapter. In Section 9.1 we will meet the fundamental recurrence relation for the values $\vartheta_p(j, n)$, found by Carlitz [54], while in Section 9.2 we list some of the polynomials P_j . In Sections 9.3 and 9.4, we will state in detail the results we announced above, and study the rational functions r_w more carefully. Section 9.5 gives an alternative form of the fundamental recurrence relation for $\vartheta_p(j, n)$, which can be written as an elegant but enigmatic infinite product. This also yields a new proof of Carlitz’ recurrence relation. Finally, we note in Section 9.6 that we can reuse the polynomials P_j for the columns in Pascal’s triangle. Proofs not given in the main section are stated in Section 9.7.

9.1 A RECURRENCE FOR THE VALUES $\vartheta_p(j, n)$

Carlitz [54] gave a recurrence relation for the values $\vartheta_p(j, n)$, which also involves another family ψ_p defined by¹

$$\psi_p(j, n) = \left| \left\{ t \in \{0, \dots, n\} : \nu_p \binom{n}{t} = j - \nu_p(n+1) \right\} \right|. \quad (189)$$

He then obtains [54, Equations (1.7)–(1.9)] for $n \geq 0$ and $j \geq 1$, using the convention $\psi_p(j, -1) = 0$,

$$\begin{aligned} \vartheta_p(j, pn+a) &= (a+1)\vartheta_p(j, n) \\ &\quad + (p-a-1)\psi_p(j-1, n-1), \quad 0 \leq a < p; \\ \psi_p(j, pn+a) &= (a+1)\vartheta_p(j, n) \\ &\quad + (p-a-1)\psi_p(j-1, n-1), \quad 0 \leq a < p-1; \\ \psi_p(j, pn+p-1) &= p\psi_p(j-1, n). \end{aligned} \quad (190)$$

Rewriting the recurrence (190) using the obvious identity

$$\psi_p(j, n) = \begin{cases} \vartheta_p(j - \nu_p(n+1), n), & j \geq \nu_p(n+1); \\ 0, & j < \nu_p(n+1), \end{cases}$$

we obtain for $0 \leq a < p$

$$\begin{aligned} \vartheta_p(j, pn+a) &= (a+1)\vartheta_p(j, n) \\ &\quad + \begin{cases} (p-a-1)\vartheta_p(j-1 - \nu_p(n), n-1), & j > \nu_p(n); \\ 0, & j \leq \nu_p(n). \end{cases} \end{aligned} \quad (191)$$

Among other things, Carlitz evaluates $\vartheta_p(j, n)$ for special values of n and studies associated generating functions. Moreover, he proves the explicit formula [54, Equation (2.5)], saying that for the base- p expansion $n = \sum_{i=0}^{v-1} n_i p^i$ we have

$$\begin{aligned} \vartheta_p(1, n) &= \sum_{0 \leq i < v-1} (n_{v-1} + 1) \cdots (n_{i+2} + 1) n_{i+1} (p - n_i - 1) \times \\ &\quad (n_{i-1} + 1) \cdots (n_0 + 1). \end{aligned} \quad (192)$$

By (185) this implies that

$$\frac{\vartheta_p(1, n)}{\vartheta_p(0, n)} = \sum_{0 \leq i < v-1} \frac{n_{i+1}}{n_{i+1} + 1} \cdot \frac{p - n_i - 1}{n_i + 1}. \quad (193)$$

In particular, counting identical summands, we obtain

$$\frac{\vartheta_p(1, n)}{\vartheta_p(0, n)} = \sum_{\substack{0 \leq c, a < p \\ c \neq 0, a \neq p-1}} \frac{c}{c+1} \cdot \frac{p-a-1}{a+1} |n|_{ca}. \quad (194)$$

¹ Our notation differs slightly from Carlitz' who wrote $\theta_j(n)$ instead of $\vartheta_p(j, n)$ and $\psi_j(n)$ instead of $\psi_p(j, n)$, omitting p altogether.

Note that we defined the quantity $|n|_{ca}$ as the number of occurrences of $(c, a) = (n_{i+1}, n_i)$ in the base- p expansion $n = \sum_{i=0}^{\infty} n_i p^i$. Since c is non-zero, this is equal to the number of occurrences of this pattern for $0 \leq i < \nu - 1$. For the prime $p = 2$ only one summand remains, yielding the formula

$$\frac{\vartheta_2(1, n)}{\vartheta_2(0, n)} = \frac{1}{2} |n|_{10}. \quad (195)$$

This formula was observed by Howard [107, Equation (2.4)], compare also [106, Theorem 2.2]. (The latter is however not correct if n is a power of 2.)

9.2 THE POLYNOMIALS P_j FOR $j > 1$

In 1971, Howard [107] also found formulae for $\vartheta_2(2, n)$, $\vartheta_2(3, n)$, and $\vartheta_2(4, n)$ in terms of factor counting functions $|n|_w$. In different notation, he obtained the formulae

$$\begin{aligned} \frac{\vartheta_2(2, n)}{\vartheta_2(0, n)} &= -\frac{1}{8} |n|_{10} + |n|_{100} + \frac{1}{4} |n|_{110} + \frac{1}{8} |n|_{10}^2, \\ \frac{\vartheta_2(3, n)}{\vartheta_2(0, n)} &= \frac{1}{24} |n|_{10} - \frac{1}{8} |n|_{110} - \frac{1}{2} |n|_{100} + \frac{1}{8} |n|_{1110} + \frac{1}{2} |n|_{1100} \\ &\quad + \frac{1}{2} |n|_{1010} + 2 |n|_{1000} - \frac{1}{16} |n|_{10}^2 + \frac{1}{8} |n|_{10} |n|_{110} \\ &\quad + \frac{1}{2} |n|_{10} |n|_{100} + \frac{1}{48} |n|_{10}^3, \\ \frac{\vartheta_2(4, n)}{\vartheta_2(0, n)} &= -\frac{1}{64} |n|_{10} + \frac{11}{384} |n|_{10}^2 - \frac{1}{64} |n|_{10}^3 + \frac{1}{384} |n|_{10}^4 - \frac{1}{4} |n|_{100} \\ &\quad - \frac{3}{8} |n|_{10} |n|_{100} + \frac{1}{8} |n|_{10}^2 |n|_{100} + \frac{1}{2} |n|_{100}^2 + \frac{1}{32} |n|_{110} - \frac{1}{2} |n|_{1100} \\ &\quad - \frac{3}{32} |n|_{10} |n|_{110} + \frac{1}{32} |n|_{10}^2 |n|_{110} + \frac{1}{4} |n|_{100} |n|_{110} + \frac{1}{32} |n|_{110}^2 \\ &\quad - |n|_{1000} - \frac{1}{2} |n|_{1010} + |n|_{10} |n|_{1000} + \frac{1}{4} |n|_{10} |n|_{1100} + \frac{1}{4} |n|_{10} |n|_{1010} \\ &\quad - \frac{1}{16} |n|_{1110} + \frac{1}{16} |n|_{10} |n|_{1110} + 4 |n|_{10000} + |n|_{11000} + |n|_{10100} \\ &\quad + \frac{1}{4} |n|_{11100} + |n|_{10010} + \frac{1}{4} |n|_{11010} + \frac{1}{4} |n|_{10110} + \frac{1}{16} |n|_{11110}. \end{aligned}$$

Moreover, Howard [108] found an expression for $\vartheta_p(2, n)$ for general primes p ; see also [109, 185]. We also refer to Spearman and Williams [171, Theorem 1]. They reproved the formulae above by expressing the quotient $\vartheta_2(j, n)/\vartheta_2(0, n)$ as a sum of nonoverlapping subwords of the binary expansion of n . We note that the factors that

are counted in the expressions for $\vartheta_2(j, n)$ always start with the digit 0 (read from right to left) and end with the digit 1. That is, the words w occurring in these expressions belong to the set W_j defined in Theorem 9.0.1. By this theorem we can always require the condition $w \in W_j$, while Proposition 9.3.1 ensures uniqueness of an expression for $\vartheta_2(j, n)$ as above.

We refrained from listing formulae for $j \geq 5$ for the obvious reason: P_5 contains 69 monomials, P_6 already 174.

Remark 31. As we noted before, the statement of the Theorem 9.0.1 formulated by Rowland can already be found implicitly in Barat and Grabner [33]. That is, their method of proof can be adapted to show the theorem. More precisely, in the course of proving [33, Theorem 5], they proved that $\vartheta_p(j, n)/\vartheta_p(0, n)$ is a sum of products of block-additive functions. Here a function $f : \mathbb{N} \rightarrow \mathbb{C}$ is called ℓ -block-additive in base p , if there is a function $F : \{0, \dots, q\}^\ell \rightarrow \mathbb{C}$ satisfying $F(0, \dots, 0) = 0$ such that for the base- p expansion $n = \sum_{i \geq 0} \varepsilon_i p^i$ we have

$$f(n) = \sum_{i \geq 0} F(\varepsilon_{i+\ell-1}, \dots, \varepsilon_i).$$

These functions were first defined by Cateland in his thesis [55]. We note that ℓ -block-additive functions are precisely the complex linear combinations of factor counting functions $|\cdot|_w$, where w contains a non-zero letter and the length $|w|$ is bounded by ℓ . It follows from [33, (3.3), (3.4)] that the ℓ -block-additive functions occurring in the representation of $\vartheta_p(j, n)/\vartheta_p(0, n)$ take only those factors $(w_{v-1} \cdots w_0) \in \{0, \dots, q\}^v$ into account such that $w_{v-1} \neq 0$ and $w_0 \neq q$. Moreover, enhancing the induction hypothesis in the proof of [33, Theorem 5], it can be shown that only ℓ -block-additive functions, where $1 \leq \ell \leq j$, appear, and that the occurring products of block-additive functions have length $\leq j$.

Rowland [160] used an approach very similar to Barat and Grabner's [33] (see also Spearman and Williams [171]) in order to obtain Theorem 9.0.1. More precisely, it follows from the proof of this theorem that the monomials $X_{w^{(1)}} \cdots X_{w^{(\ell)}}$ occurring in the polynomial P_j satisfy

$$|w^{(1)}| + \cdots + |w^{(\ell)}| - \ell \leq j. \tag{196}$$

For example, if $p = 2$ and $j = 2$, only the monomials $1, X_{10}, X_{10}^2, X_{100}$ and X_{110} can occur. Based on (196) we will derive in Corollary 9.3.8 an upper bound for the number of monomials in P_j .

We note that we always write words from right to left, since our interest in them stems from base- p expansions of an integer. Correspondingly, to name a consequence of this convention, a prefix of a word starts with the rightmost letter.

9.3 COMPUTING THE COEFFICIENTS OF P_j

Let p be a prime number throughout this section. For brevity of notation, we omit the index p whenever there is no risk of confusion. As in Theorem 9.0.1, let

$$W_j = \{w \in \{0, \dots, q\}^v : 2 \leq v \leq j + 1, w_{v-1} \neq 0, w_0 \neq q\},$$

moreover we define the set of *admissible* words,

$$W = \bigcup_{j \geq 1} W_j.$$

In order to get meaningful statements on the coefficients of P_j , let us first show that the polynomial P_j is well-defined, i.e., uniquely determined. Note that it is not clear a priori that there is only one polynomial P_j representing $\vartheta_p(j, n) / \vartheta_p(0, n)$ as in (188): the values inserted into this polynomial are not independent of each other, therefore we can not use Lagrange interpolation directly for establishing uniqueness. For example, for $p = 2$ we have $|n|_{10} \geq |n|_{100}$ for all n , so that not all tuples $(n_w)_{w \in W_j}$ of non-negative integers can occur as family $(|n|_w)_{w \in W_j}$ of block counts of a non-negative integer n . Moreover, for the polynomial to be unique it is necessary that the blocks we are counting satisfy some restrictions, since there are obvious identities such as $|n|_1 = |n|_{01} + |n|_{11}$. We will show that the restriction $w_{v-1} \neq 0, w_0 \neq q$ in Theorem 9.0.1 leads to a unique polynomial P_j after all.

Proposition 9.3.1. *There is at most one polynomial P_j in the variables X_w , where $w \in W$, such that*

$$\frac{\vartheta_p(j, n)}{\vartheta_p(0, n)} = P_j((|n|_w)_{w \in W})$$

for all $n \geq 0$.

In order to prepare for the main theorem, we define generating functions of the values $\vartheta_p(j, n)$, which occupy a central position in the statements of the main results.

$$T_n(x) := \sum_{j \geq 0} \vartheta_p(j, n) x^j = \sum_{0 \leq t \leq n} x^{v_p \binom{n}{t}}. \tag{197}$$

Obviously, $T_n(x)$ is a polynomial of degree $\max_{t \leq n} v_p \binom{n}{t}$, which is sequence A119387 in Sloane’s OEIS for the case $p = 2$. The recurrence (191) for ϑ_p translates to the generating functions $T_n(x)$ as follows:

$$\begin{aligned} T_a(x) &= a + 1, \\ T_{pn+a}(x) &= (a + 1)T_n(x) + (p - a - 1)x^{s+1}T_{n-1}(x), \end{aligned} \tag{198}$$

for $n \geq 1$ and $0 \leq a < p$, where $s = v_p(n)$. We note the special case

$$T_{cp^t-1}(x) = cp^t, \quad 1 \leq c < p, t \geq 0,$$

which we will use often.

Remark 32. Using the recurrence (198), one can show by induction that

$$\deg T_n(x) = \lambda - v_p(m + 1)$$

for $n \geq 1$, where $\lambda \geq 0$ and $m \in \{0, \dots, p^\lambda - 1\}$ are chosen such that $n = cp^\lambda + m$ for some $c \in \{1, \dots, p - 1\}$.

Let us compute some polynomials T_n for $p = 2$. From the recurrence (198), we obtain

$$\begin{aligned} T_0(x) &= 1, & T_1(x) &= 2, \\ T_2(x) &= 2 + x, & T_3(x) &= 4, \\ T_4(x) &= 2 + x + 2x^2, & T_5(x) &= 4 + 2x, \\ T_6(x) &= 4 + 2x + x^2, & T_7(x) &= 8, \\ T_8(x) &= 2 + x + 2x^2 + 4x^3, & T_9(x) &= 4 + 2x + 4x^2. \end{aligned}$$

Note that $T_n(1) = n + 1$, since the n -th row of Pascal's triangle contains $n + 1$ entries. Moreover, we define normalized generating functions \bar{T}_n :

$$\bar{T}_n(x) = \frac{1}{\vartheta_p(0, n)} T_n(x).$$

By definition, we have $[x^0] \bar{T}_n(x) = 1$. We are extending these notations to finite words v in $\{0, \dots, q\}$ via the base- p expansion: if $(v)_p = n$, we set $T_v := T_n$ and $\bar{T}_v := \bar{T}_n$. Based on the polynomials $\bar{T}_n(x)$, we shall define the rational functions r_w occurring in the main theorem. In order to do so, we define the *left truncation* w_L and the *right truncation* w_R on the set $W \cup \{\varepsilon\}$, as follows. For $w \in W$, $r \geq 1$ $s \geq 0$, and digits $c \neq 0$ and $a \neq q$, let

$$\begin{aligned} \varepsilon_L &= \varepsilon, & (c0^r)_L &= \varepsilon, & (c0^s a)_L &= \varepsilon, & (c0^s w)_L &= w; \\ \varepsilon_R &= \varepsilon, & (q^r a)_R &= \varepsilon, & (cq^s a)_R &= \varepsilon, & (wq^s a)_R &= w. \end{aligned}$$

In other words, for $w \in W$ the word w_L is the longest proper prefix u of w (read from right to left) such that $u \in W \cup \{\varepsilon\}$. Analogously, w_R is the longest proper suffix u of w such that $u \in W \cup \{\varepsilon\}$. Note that we have $(w_L)_R = (w_R)_L$ for all $w \in W \cup \{\varepsilon\}$; we write w_{LR} for the common value. In what follows, we write $\bar{T}_n \equiv \bar{T}_n(x)$ as a shorthand. The following proposition, a telescoping product, is one of the central points of this chapter, and leads directly to the main theorem.

Proposition 9.3.2. *Let $v \in W \cup \{\varepsilon\}$. Then we have the identity*

$$\bar{T}_v = \prod_{w \in W} \left(\frac{\bar{T}_w \bar{T}_{w_{LR}}}{\bar{T}_{w_R} \bar{T}_{w_L}} \right)^{|v|_w}. \tag{199}$$

We note that we do not use the explicit definition of \overline{T}_w in the proof of this proposition. We only need the property $\overline{T}_w(0) = 1$, so that we may take quotients, and the property $\overline{T}_\varepsilon = 1$. In other words, we will show that the product reduces to the fraction $\overline{T}_v/\overline{T}_\varepsilon$ by canceling identical factors. The following example clarifies this point.

Example 9.3.3. Let $p = 2$ and $v = 100100$. Then we have

$$\frac{\overline{T}_v}{\overline{T}_\varepsilon} = \left(\frac{\overline{T}_{10}\overline{T}_\varepsilon}{\overline{T}_\varepsilon\overline{T}_\varepsilon}\right)^2 \left(\frac{\overline{T}_{100}\overline{T}_\varepsilon}{\overline{T}_{10}\overline{T}_\varepsilon}\right)^2 \left(\frac{\overline{T}_{10010}\overline{T}_\varepsilon}{\overline{T}_{100}\overline{T}_{10}}\right) \left(\frac{\overline{T}_{100100}\overline{T}_{10}}{\overline{T}_{10010}\overline{T}_{100}}\right).$$

The use of this proposition will reveal itself in a moment, when we will combine it with the uniqueness of the coefficients of P_j (Proposition 9.3.1). For each admissible word w we can finally define the rational generating function

$$r_w(x) := \frac{\overline{T}_w(x)\overline{T}_{w_{LR}}(x)}{\overline{T}_{w_L}(x)\overline{T}_{w_R}(x)}.$$

Now that we know r_w , our main theorem 9.0.2 can be stated completely explicitly.

Theorem 9.3.4. Assume that $w^{(1)}, \dots, w^{(\ell)}$ are admissible words and that k_1, \dots, k_ℓ are positive integers. Let c_j be the coefficient of the monomial

$$X_{w^{(1)}}^{k_1} \cdots X_{w^{(\ell)}}^{k_\ell}$$

in the polynomial P_j . Then

$$\sum_{j \geq 0} c_j x^j = \frac{1}{k_1!} (\log r_{w^{(1)}}(x))^{k_1} \cdots \frac{1}{k_\ell!} (\log r_{w^{(\ell)}}(x))^{k_\ell}.$$

Proof. By (199), by the definition of \overline{T}_n as $[x^j]\overline{T}_n(x) = \vartheta_p(j, n)/\vartheta_p(0, n)$, and by Theorem 9.0.1, we have

$$[x^j] \prod_{w \in W_j} r_w(x)^{|n|_w} = P_j \left((|n|_w)_{w \in W_j} \right)$$

for all $n \in \mathbb{N}$. Let us reveal how the polynomial structure emerges in the left-hand side. The idea is to apply an exp-log decomposition on (199). This is legitimate, as the constant term of $\overline{T}_n(x)$ and therefore of $r_w(x)$ is 1, compare (197). We have the identity

$$\begin{aligned} [x^j] \prod_{w \in W_j} r_w(x)^{|n|_w} &= [x^j] \prod_{w \in W_j} \exp(|n|_w \log r_w(x)) \\ &= [x^j] \prod_{w \in W_j} \sum_{k \geq 0} |n|_w^k \frac{(\log r_w(x))^k}{k!} \\ &= \sum_{\substack{k_w \geq 0 \\ w \in W_j}} \left([x^j] \prod_{w \in W_j} \frac{(\log r_w(x))^{k_w}}{k_w!} \right) \prod_{w \in W_j} |n|_w^{k_w}, \end{aligned}$$

where the last step is justified since there are only finitely many summands contributing to the j -th coefficient. (This is the case by the condition $r_w(0) = 1$, which implies $\log r_w(x) = \mathcal{O}(x)$ for $x \rightarrow 0$.)

The right-hand side is a polynomial in $|n|_w$ for $w \in W$, and by the uniqueness result (Proposition 9.3.1) the theorem is proved. \square

Remark 33. In fact the argument given in the proof also gives a new proof of existence of the polynomials P_j .

As a straightforward application of Theorem 9.3.4 we obtain the corollary 9.0.3 from the introduction, which we restate here.

Corollary 9.3.5. *The coefficient of X_{10} in the polynomial P_j is equal to $[x^j] \log(1 + x/2)$. In particular,*

$$\sum_{j \geq 0} c_j = \log(3/2).$$

Proof. In this simple case all we need is $r_{10}(x) = \bar{T}_2(x) = 1 + \frac{x}{2}$, which does not have a singularity or a zero in the closed unit disc. \square

Here are the first few rational functions r_w :

$$\begin{aligned} r_{10}(x) &= 1 + \frac{1}{2}x, \\ r_{100}(x) &= 1 + \frac{x^2}{1 + x/2}, \\ r_{110}(x) &= 1 + \frac{\frac{1}{4}x^2}{1 + x/2}, \\ r_{1000}(x) &= 1 + \frac{2x^3}{1 + x/2 + x^2}, \\ r_{1010}(x) &= 1 + \frac{\frac{1}{2}x^3}{(1 + x/2)^2}, \\ r_{1100}(x) &= 1 + \frac{\frac{1}{2}x^3}{(1 + x/2 + x^2)(1 + x/2 + x^2/4)}. \end{aligned}$$

Continuing this computation, and performing analogous experiments for the prime numbers 3, 5, 7 in order to obtain a conjecture on the structure of r_w , we arrive at the statement of the following proposition.

Proposition 9.3.6. *Let p be a prime number and let $w = w_{v-1} \cdots w_0 \in W$. The rational function $r_w(x)$ satisfies*

$$r_w(x) = 1 + \frac{\alpha x^{v-1}}{\bar{T}_{w_L}(x)\bar{T}_{w_R}(x)},$$

where

$$\alpha = p^{v-2} \frac{w_{v-1}}{w_{v-1} + 1} \cdot \frac{p - w_0 - 1}{w_0 + 1} \prod_{2 \leq d \leq p} d^{-2|w'|_{d-1}}, \tag{200}$$

and $w' = w_{v-2} \cdots w_1$.

Consider the special case $w = ca$ of this proposition. We obtain $\alpha = \frac{c}{c+1} \frac{p-a-1}{a+1}$, which gives the formula $\bar{T}_{ca} = 1 + \frac{c}{c+1} \frac{p-a-1}{a+1} x$ (compare to (215)). By Theorem 9.3.4 we obtain the coefficient of X_{ca} in the polynomial P_1 by extracting the coefficient

$$[x^1] \log\left(1 + \frac{c}{c+1} \frac{p-a-1}{a+1} x\right) = \frac{c}{c+1} \frac{p-a-1}{a+1},$$

which is consistent with (194).

Remark 34. By Proposition 9.3.6 we can determine exactly for which j a given monomial occurs first. Since $\bar{T}_v(0) = 1$ for all admissible words v , we have $r_w(x) = 1 + \alpha x^k + \mathcal{O}(x^{k+1})$, where α is given by (200) and $k = |w| - 1$, therefore $\log r_w(x) = \alpha x^k + \mathcal{O}(x^{k+1})$ for some $\alpha \neq 0$. By Theorem 9.3.4 the monomial X_w occurs first in the polynomial P_j , where $j = |w| - 1$. More generally, the monomial $X_{w^{(1)}} \cdots X_{w^{(k)}}$ (repetitions allowed) occurs first in P_j , where $j = |w^{(1)}| + \cdots + |w^{(k)}| - k$. That is, the lower bound for the first occurrence of a monomial given by (196) is sharp.

We note that this observation is not sufficient to determine the number of terms in P_j ; in the generating function appearing in Theorem 9.3.4 some higher coefficients may vanish. This is for example the case for $w = 110$. We have

$$\log r_{110}(x) = \log\left(\frac{1 - (x/2)^3}{1 - (x/2)^2}\right) = \sum_{i \geq 1} \frac{x^{2i}}{i4^i} - \sum_{i \geq 1} \frac{x^{3i}}{i8^i},$$

and consequently the monomial X_{110} does not occur in P_j for $j = 6\ell \pm 1$, where $\ell \geq 1$. It is however true that each nontrivial monomial occurs in infinitely many P_j .

Corollary 9.3.7. *Each monomial $X_{w^{(1)}}^{k_1} \cdots X_{w^{(\ell)}}^{k_\ell}$ except for the constant term 1 occurs in infinitely many P_j .*

Proof. By Theorem 9.3.4 the claim is equivalent to the fact that

$$\prod_{i=1}^{\ell} (\log r_{w^{(i)}}(x))^{k_i}$$

is not a polynomial. We will analyze the possible singularities, which will contradict a polynomial behavior.

Assume that ρ_i is the radius of convergence of the power series $\log r_{w^{(i)}}(x)$ and choose $j \in \{1, \dots, \ell\}$ such that $\rho_j = \min_{1 \leq i \leq \ell} \rho_i$, moreover let x_j be a singularity of $\log r_{w^{(j)}}(x)$ on the circle $\{x : |x| = \rho_j\}$. By Proposition 9.3.6 we have $0 < \rho_j < \infty$, and that the power series $\log r_{w^{(i)}}(x)$ does not have a zero apart from $x = 0$. Therefore the singularities cannot cancel, which implies that x_j is a singularity of $(\log r_{w^{(1)}}(x))^{k_1} \cdots (\log r_{w^{(\ell)}}(x))^{k_\ell}$. Consequently, this expression is not a polynomial. \square

Moreover, we want to derive an asymptotic estimate of the number of terms in P_j , using Proposition 9.3.6.

Corollary 9.3.8. *The number of terms N_j in the polynomial P_j satisfies the bound*

$$N_j \leq [x^j] \frac{1}{1-x} \exp \left(\sum_{k \geq 1} \frac{1}{k} \frac{(p-1)^2 x^k}{1-px^k} \right).$$

Asymptotically, for $j \rightarrow \infty$, this upper bound is

$$\frac{e^{\mu(\sigma-1/2)}}{2p\mu^{1/4}\sqrt{\pi}} \frac{e^{2\sqrt{\mu j}} p^j}{j^{3/4}} \left(1 + \mathcal{O} \left(\frac{1}{\sqrt{n}} \right) \right),$$

with the constants $\mu = \frac{(p-1)^2}{p}$ and $\sigma = \sum_{k \geq 2} \frac{1}{k} \frac{1}{p^{k-1}-1}$. Moreover, we have

$$N_j = \Theta(p^j e^{2\sqrt{\mu j}} j^{-3/4}).$$

The same estimates are true for the number N'_j of terms in the polynomials P'_j .

Proof. The terms in P_j are built from the variables in W_j , see (187). In $W = \bigcup_{j \geq 1} W_j$ there are $p^{k-1}(p-1)^2$ many words w of weight $|w| - 1$ equal to k , for $k \geq 2$. The corresponding generating function is $\mathcal{W}(x) = (p-1)^2 \frac{x}{1-px}$.

First, we want to determine the number of monomials having total weight j . By (196) these are the monomials that are part of P_j but not of P_{j-1} , we obtain therefore the maximal number of “new” monomials in P_j .

A monomial is nothing else but a multiset of variables in W . Thus, by the multiset construction (see [85, page 27]) we obtain the exp-part of the generating function in the corollary. Finally, the factor $\frac{1}{1-x}$ stems from the fact that also monomials from P_0, \dots, P_{j-1} are allowed in P_j .

For the asymptotic result, we first need to find the dominant singularity, i.e., the one closest to the origin. Note that the possible singularities are at $\omega_k^\ell p^{-1/k}$, for $\ell = 0, \dots, k-1$, where $\omega_k = \exp(2\pi i/k)$ is a k -th root of unity. As $p \geq 2$ the dominant one is found at $1/p$ for $k = 1$. Thus, we may decompose our generating function into

$$\exp \left(\frac{(p-1)^2 x}{1-px} \right) S(x),$$

where $S(x)$ is the generating function of the remaining factors. The crucial observation is that $S(x)$ is analytic for $|x| < 1/\sqrt{p}$, hence, for $|x| < 1/p$. This is a well-known type of functions for which a complete asymptotic expansion is known. Using Wright’s result [188, Theorem 2] we get the final result. The constants are coming from $S(1/p)$. The last statement follows from Proposition 9.3.6 and the

asymptotic statement, since the number of “new” monomials occurring with a non-zero coefficient is a positive portion of the asymptotic main term. \square

This type of functions was already intensively considered in the literature. It appears in the enumeration of permutations. The analysis builds on a saddle point method, see [85, Example VIII.7, p. 562]. Wright [188] derived the asymptotics for the general form of an exponential singularity we encounter here, extending the work of Peron [154].

Remark 35. We note that for the upper bound in Corollary 9.3.8 we do not need Proposition 9.3.6, but it suffices to use Rowland’s paper, see (196). The lower bound however uses the fact that all “new” monomials do occur in the polynomial P_j , by Proposition 9.3.6.

For the prime $p = 2$, we implemented the method of finding the coefficients of P_j by Theorem 9.3.4 in the Sage computer algebra system. In particular, we retrieve the formulae for $\vartheta_2(2, n), \dots, \vartheta_2(4, n)$ obtained by Howard [107], Spearman and Williams [171] and Rowland [160] before. Computing P_0, \dots, P_{11} took less than five minutes using our implementation, which is a significant improvement over Rowland’s algorithm [160].

We compare the actual number of non-zero coefficients in P_j (first line of numbers) with the upper bound from Corollary 9.3.8 (second line).

P_0	P_1	P_2	P_3	P_4	P_5	P_6	P_7	P_8	P_9	P_{10}	P_{11}
1	1	4	11	29	69	174	413	995	2364	5581	13082
1	2	5	12	30	72	176	420	1005	2378	5611	13144

From this numerical evidence it seems reasonable to conjecture that the upper bound given in Corollary 9.3.8 gives in fact the asymptotic main term of the number N_j of non-zero coefficients of P_j . However, the exact behavior of the integers N_j seems to be difficult to grasp, and remains an open problem at the moment.

9.4 ASYMPTOTIC BEHAVIOR OF THE COEFFICIENTS

In this section we study the different asymptotic behaviors exhibited by a sequence $(c_j)_{j \geq 0}$ of coefficients of a monomial. More precisely, we restrict ourselves to $p = 2$ and monomials X_w for $w \in W$. The following lemma explains how the coefficients of the logarithm of a rational function behave asymptotically. We will apply it repeatedly in the subsequent discussion.

Lemma 9.4.1 (Coefficient asymptotics of $\log \circ \text{rat}$). *Let $r(x)$ be a rational function defined at 0 such that $r(0) = 1$. Choose $L \geq 0$, $\varepsilon_0, \dots, \varepsilon_{L-1} \in \mathbb{Z} \setminus \{0\}$ and pairwise different $\zeta_0, \dots, \zeta_{L-1} \in \mathbb{C} \setminus \{0\}$ in such a way that*

$$r(x) = (1 - \zeta_0 x)^{\varepsilon_0} \cdots (1 - \zeta_{L-1} x)^{\varepsilon_{L-1}}.$$

(Note that this decomposition is unique up to the order of the factors.) Then

$$[x^n] \log r(x) = -\frac{1}{n} \sum_{0 \leq i < L} \varepsilon_i \zeta_i^n \tag{201}$$

for $n \geq 1$. In particular, if we assume w.l.o.g. that $\zeta_0, \dots, \zeta_{m-1}$, for some $1 \leq m \leq L$, have maximal absolute value among the ζ_i , and $M = |\zeta_0|$, then

$$[x^n] \log r(x) = -\frac{1}{n} \sum_{0 \leq i < m} \varepsilon_i \zeta_i^n + \mathcal{O}((M - \varepsilon)^n) \tag{202}$$

for some $\varepsilon > 0$. If moreover $m = 1$, we have for all $k \geq 1$

$$[x^n] (\log r(x))^k = k(-\varepsilon_0)^k (\log n)^{k-1} \frac{\zeta_0^n}{n} \left(1 + \mathcal{O}\left(\frac{1}{n}\right)\right). \tag{203}$$

Proof. The first two statements follow immediately from the identity

$$[x^n] \log \left(\frac{1}{1-x} \right) = [x^n] \sum_{n \geq 1} \frac{x^n}{n} = \frac{1}{n}. \tag{204}$$

The asymptotic statements can be proved using standard results from singularity analysis (see Flajolet and Sedgewick [85]). We begin with the case that $m = 1$. First of all, the location of the dominant singularity (the one closest to the origin) is responsible for the exponential growth of the coefficients. Next note that the function $\log r(x)$ is singular if the rational function is either singular, or takes the value 0. If we assume that $\varepsilon_0 > 0$, the dominant singularity comes from the zero $1/\zeta_0$ of the numerator of $r(x)$, and the exponential growth of the n -th coefficient is given by ζ_0^n . More precisely, a Taylor expansion of $r(x)$ at $x = r$ shows that

$$\log(r(x)) = \log(h(x)(x-r)^{d_r}) = -d_r \log\left(\frac{1}{1-x/r}\right) + \log(h(x)),$$

where $\log(h(x))$ is analytic for $|x| \leq |r| + \varepsilon$. If $\varepsilon_0 < 0$, we simply swap numerator and denominator of $r(x)$ and adjust the sign. If $m > 1$ one deals separately with the different singularities.

If higher powers of the logarithm are considered we have to deal with Cauchy products. In this case one can elementarily show the appearance of the $(\log n)^{k-1}$ terms by partial summation combined with $\sum_{k=1}^n \frac{1}{k} = \log n + \mathcal{O}(1)$. For more details we refer to [85, Chapter VI]. \square

Examples. Let $p = 2$ and consider $\log(r_{110}(x)) = \log\left(\frac{1+x/2+x^2/4}{1+x/2}\right)$. Here, the numerator has the two roots $2e^{2\pi i/3}$ and $2e^{-2\pi i/3}$, whereas the denominator has the root -2 . In this case all roots lie on the same circle $|x| = 2$, and therefore cancellations take place (compare Remark 34). By (201) we obtain

$$[x^n] \log r_{110}(x) = \frac{2^{-n}}{n} \left((-1)^n - e^{2\pi i n/3} - e^{-2\pi i n/3} \right).$$

In this special case we have equality, as no other roots are involved. Since the radius of convergence is larger than 1, we can obtain the infinite sum of coefficients c_j of X_{110} by inserting 1 into the generating function:

$$\begin{aligned} \sum_{j \geq 0} c_j &= \sum_{j \geq 0} [x^j] \log r_{110}(x) = \lim_{j \rightarrow \infty} [x^j] \frac{\log r_{110}(x)}{1-x} \\ &= \log r_{110}(1) = \log(7/6). \end{aligned}$$

Now we consider the generating function $\frac{1}{2}(\log(1+x/2))^2$ corresponding to the coefficients c_j of X_{10}^2 . In this case we have, by (203),

$$c_j = \frac{(-1)^j \log j}{j \cdot 2^j} (1 + \mathcal{O}(1/j)).$$

In this simple case an exact form of the coefficients can be obtained from (201), using the Cauchy product of

$$\log r_{10}(x) = \sum_{j \geq 1} \frac{(-1)^j}{j \cdot 2^j} x^j$$

with itself:

$$c_j = [x^j] \frac{1}{2} (\log r_{10}(x))^2 = \frac{(-1)^j}{2^{j+1}} \sum_{\substack{i_1, i_2 \geq 1 \\ i_1 + i_2 = j}} \frac{1}{i_1 i_2}.$$

Moreover, similarly as in the first example we have

$$\sum_{j \geq 0} c_j = \frac{1}{2} (\log(3/2))^2.$$

Let us now consider special classes of monomials, whose generating function has a large radius of convergence and can be evaluated at $x = 1$.

Corollary 9.4.2. *Consider the words $w = 1^s 0$ or $w = 1^{4s+1} 00$ for $s \geq 1$. For fixed word w and an integer $k \geq 0$ let c_j be the coefficient of the corresponding monomial X_w^k . Then the radius of convergence of $\sum_{j \geq 0} c_j x^j$ is greater than 1 (more precisely, equal to 2 for the first family of values). Thus,*

$$\sum_{j \geq 0} c_j = \frac{1}{k!} \log(r_w(1))^k.$$

Proof. By the main theorem the considered generating function is given by $\frac{1}{k!} \log(r_w(x))^k$. Let us start with the first family of words. We need to analyze the rational function $r_w(x) = \frac{T_{1^s 0}(x)}{T_{1^s-1_0}(x)}$, as our plan is to apply Lemma 9.4.1. It is not difficult to show (see also (213)) that

$$T_{1^s 0}(x) = \frac{1 - (x/2)^{s+1}}{1 - x/2}.$$

Thus, $r_w(x) = \frac{1 - (x/2)^{s+1}}{1 - (x/2)^s}$, and we see that all roots of the numerator and the denominator are located on the circle $|x| = 2$.

For the second family of words, we get

$$T_{1^r 00}(x) = \frac{q_{r+1}(x/2)}{q_r(x/2)} \cdot \frac{1 - (x/2)^r}{1 - (x/2)^{r+1}}, \quad q_r(t) = 4t^{r+1} + t^r - 4t^2 - 1.$$

Hence, we are interested in the roots of the polynomials $q_r(x)$. By Rouché's Theorem there are exactly 2 roots inside the disc $|t| < 2^{-1}(1 + 2^{-r+2})$. These two are very close to $\pm i/2$. In particular, by Newton's method starting with $i/2$, we get after one iteration the very good approximation

$$\frac{i}{2} + \left(\frac{i}{2}\right)^r \left(\frac{1}{2} - \frac{i}{4}\right) + \mathcal{O}\left(\frac{1}{2^{2r}}\right).$$

Therefore, the roots of $q_r(t)$ are in absolute value greater than $1/2$ for $r \equiv 1, 2 \pmod{4}$ and less than $1/2$ for $r \equiv 0, 3 \pmod{4}$. In particular, for $r \equiv 1 \pmod{4}$ we have that the roots of $q_{r+1}(x/2)$ and $q_r(x/2)$ are both in absolute value greater than 1. Thus, the radius of convergence is larger than 1, and it is legitimate to insert 1. \square

By Lemma 9.4.1 the sequence of coefficients $(c_j)_{j \geq 0}$ for a given word w can exhibit different kinds of behaviors, corresponding to the position of the zeros and singularities of $r_w(x)$. Because of the construction of $r_w(x)$, there is a convergence–divergence dichotomy, which we summarize in the following corollary.

Corollary 9.4.3. *Let $w \in W$ and write $r_w(x) = (1 - \xi_0 x)^{\varepsilon_0} \cdots (1 - \xi_{L-1} x)^{\varepsilon_{L-1}}$ with pairwise different, non-zero $\xi_i \in \mathbb{C}$ and non-zero $\varepsilon_i \in \mathbb{Z}$, such that $|\xi_0| \geq \cdots \geq |\xi_{L-1}|$.*

(a) *If $|\xi_0| \leq 1$, the sequence c_w converges. Moreover we have the convergent series*

$$\sum_{j \geq 0} c_j = \log r_w(1).$$

(b) *If $|\xi_0| > 1$, the sequence c_w diverges. If moreover $1/\xi_0$ is the only dominant singularity, then ξ_0 is a real number in $(-\infty, -1]$, and we have $c_w(j) \sim -\varepsilon_0 \xi_0^j / j$.*

Proof. The case that $|\zeta_0| < 1$ is clear, since the function $\log r_w(x)$ has no singularity in the closed unit disc in this case. For the case $|\zeta_0| = 1$ we note that $\zeta_i \neq 1$ for all i , since T_v has only positive coefficients. Since the sum $\sum_{j \geq 1} \zeta^j/j$ converges for all $\zeta \neq 1$ on the unit circle, the sum $\sum_{j \geq 1} c_j$ converges by (201). Abel's limit theorem finishes the proof for this case. Finally, case (b) follows from Lemma 9.4.1 and the positivity of coefficients of T_v . \square

In the following, let $p = 2$. We have seen (Corollaries 9.3.5 and 9.4.2) that case (a) occurs for $w = 1^s 0$, where $s \geq 1$.

Case (b) appears for $w = 1010$ (dominant singularity at $x_0 \sim -0.86408$). In this case the singularity is coming from the log, as $r_w(x_0) = 0$. Thus log becomes singular. This is also called a supercritical composition scheme, as the outer function is responsible for the singularity.

This case also appears for $w = 10100$ (dominant singularity again at $x_0 \sim -0.86408$). In this case however, the denominator of r_w is zero at x_0 , thus the singularity is coming from a simple pole. This is also called a subcritical composition scheme, as the inner function is responsible for the singularity.

By approximate computation of the roots of \bar{T}_v using GNU Octave we determined all words of length at most 10 for which case (a) occurs. Besides for the words of the form $1^s 0$ or $1^{4s+1} 00$, this also seems to be the case for the words $1^s 0 1^t 0$, where $s \geq 1$ and $t \geq 2$. Here is the list of remaining words $w \in W$ of length at most 10, not falling into one of these three classes, for which this case occurs too.

10011110,	101101110,	101110110,
101111010,	101111100,	111011010,
1011011110,	1011101110,	1011110110,
1101101110,	1101110110,	1101111010,
1101111100,	1111011010.	

We leave the classification of the words $w \in W$ for which the sum $\sum_{j \geq 0} c_j$ converges as an open problem.

9.5 A SIMPLIFIED RECURRENCE FOR $\vartheta_p(j, n)$

Rarefying $\vartheta_p(j, n)$ in the first coordinate by the factor $p - 1$, and shifting j by $s_p(n)$ many places, the recurrence (191) is transformed into a simpler form: the term ν_p disappears, instead the maximal shift oc-

curing in the first coordinate is $2p - 1$. We pass to the details. Define, for $k, n \geq 0$,

$$\tilde{\vartheta}_p(k, n) = \begin{cases} \vartheta_p((k - s_p(n))/(p - 1), n), & k \geq s_p(n) \text{ and} \\ & p - 1 \mid k - s_p(n); \\ 0, & \text{otherwise.} \end{cases} \quad (205)$$

Setting for simplicity $\tilde{\vartheta}_p(k, n) = 0$ if $k < 0$ or $n < 0$, we obtain the following recurrence relation for $k, n \geq 0$, where we use the Kronecker delta, which is defined by $\delta_{i,i} = 1$, and $\delta_{i,j} = 0$ for $i \neq j$.

$$\begin{aligned} \tilde{\vartheta}_p(0, n) &= \delta_{0,n}, \quad \text{for } n \geq 0; \\ \tilde{\vartheta}_p(k, 0) &= \delta_{k,0}, \quad \text{for } k \geq 0, \end{aligned} \quad (206)$$

and for $n \geq 0$ and $0 \leq a < p$,

$$\begin{aligned} \tilde{\vartheta}_p(k, pn + a) &= (a + 1)\tilde{\vartheta}_p(k - a, n) \\ &\quad + (p - a - 1)\tilde{\vartheta}_p(k - p - a, n - 1). \end{aligned} \quad (207)$$

The proof of this new recurrence is straightforward and uses the identity

$$s_p(n + 1) - s_p(n) = 1 - (p - 1)v_p(n + 1), \quad (208)$$

which follows immediately by writing n in base p and counting the number of times the digit q occurs at the lowest digits of n , and also the recurrence

$$s_p(pn + a) = s_p(n) + a \quad \text{with } 0 \leq a < p.$$

In Tables 22–24 we list some coefficients of $\tilde{\vartheta}_p(k, n)$ for $p = 2, 3, 5$, respectively.

Next, we want to derive a product representation from the recurrence (207). In order to do so, we note the well-known fact due to Legendre stating that

$$v_p(n!) = \frac{n - s_p(n)}{p - 1}, \quad (209)$$

for prime p . This can be proved easily by summing the identity (208). Applying (209) three times, we obtain

$$v_p \binom{n}{t} = \frac{s_p(n - t) + s_p(t) - s_p(n)}{p - 1}. \quad (210)$$

We note that, by Kummer’s theorem [132], the left-hand side of (210) is the number of borrows occurring in the subtraction $n - t$.

Let us define the bivariate generating function $\tilde{T}(x, z)$ as follows $\sum_{k,n \geq 0} \tilde{\vartheta}_p(k, n)x^k z^n$. We will prove that \tilde{T} can be written compactly as

	0	1	2	3	4	5	6	7	8	9	10	11	12	13	14	15	16	17
0	1																	
1		2	2		2				2								2	
2			1	4	1	4	4		1	4	4		4				1	4
3					2	2	2	8	2	2	4	8	2	8	8		2	2
4							1		4	4	1	4	5	4	4	16	4	4
5											2		2	2	2		8	8
6															1			

Table 22: The first coefficients of $\tilde{\vartheta}_2(k, n)$, where empty entries denote 0's. The first variable corresponds to the row, the second one to the column.

	0	1	2	3	4	5	6	7	8	9	10	11	12	13	14	15	16	17
0	1																	
1		2		2						2								
2			3		4		3				4		4					
3				2		6		6		2		6		8		6		
4					1		4		9		4		5		12		12	
5								2		6		6		4		8		18
6											3		4		3		4	
7														2		2		
8																		1

Table 23: The first coefficients of $\tilde{\vartheta}_3(k, n)$, where empty entries denote 0's. The first variable corresponds to the row, the second one to the column.

an infinite product. By definition (205), the binomial coefficient $\binom{n}{t}$ contributes to $k = s_p(n) + (p - 1)v_p\binom{n}{t}$. Thus, we obtain by (210)

$$\begin{aligned} \tilde{T}(x, z) &= \sum_{n \geq 0} z^n \sum_{t=0}^n x^{s_p(n) + (p-1)v_p\binom{n}{t}} = \sum_{n \geq 0} z^n \sum_{t=0}^n x^{s_p(t) + s_p(n-t)} \\ &= \left(\sum_{n \geq 0} z^n x^{s_p(n)} \right)^2 = \prod_{i \geq 0} \left(1 + xz^{p^i} + x^2z^{2p^i} + \dots + x^{p-1}z^{(p-1)p^i} \right)^2, \end{aligned}$$

where the last equality holds due the uniqueness of the base- p expansion of an integer n . This product representation should be com-

	0	1	2	3	4	5	6	7	8	9	10	11	12	13	14	15	16	17
0	1																	
1		2				2												
2			3				4			3								
3				4				6			6				4			
4					5				8			9				8		
5						4				10			12				12	
6							3				8			15				
7								2				6			12			
8									1				4			9		
9														2			6	

Table 24: The first coefficients of $\tilde{\vartheta}_5(k, n)$, where empty entries denote 0's. The first variable corresponds to the row, the second one to the column.

pared to Carlitz [54, Equations (3.3), (3.12)]. Since he does not use the transformation in the first coordinate, his product takes a more complicated form. For $p = 2$ we have the special case

$$\sum_{k,n \geq 0} \tilde{\vartheta}_2(k, n) x^k z^n = \prod_{i \geq 0} (1 + xz^{2^i})^2.$$

We note that this product representation can be used for an alternative proof of Carlitz' recurrence (190).

We finish this section with a remark on divisibility in columns of Pascal's triangle.

9.6 DIVISIBILITY IN COLUMNS OF PASCAL'S TRIANGLE

In the recent paper [68] by Drmota, Kauers, and Spiegelhofer, we deal with a conjecture by Cusick (private communication, 2012, 2015) stating that

$$c_t := \text{dens}\{m \geq 0 : s_2(m + t) \geq s_2(m)\} > 1/2,$$

for all $t \geq 0$. Here $\text{dens } A$ denotes the asymptotic density of a set $A \subseteq \mathbb{N}$, which exists in this case. By (210) this corresponds to a problem

on divisibility in columns of Pascal’s triangle: if we define $\rho_2(j, t) = \text{dens}\{m \geq 0 : v_2\binom{m+t}{m} = j\}^2$, the conjecture states that

$$\sum_{j \leq s_2(t)} \rho_2(j, t) > 1/2. \tag{211}$$

The authors of [68, Theorem 1] gave a partial answer, solving the conjecture for almost all t in the sense of asymptotic density. The full statement is however still an open problem.

Surprisingly, the “column densities” $\rho_2(j, t)$ can be expressed by the same polynomial P_j as the “row counts” $\vartheta_2(j, n)$ (see [68, Sections 3.2 and 3.3]). We have $\rho_2(0, t) = 2^{-|t|_1}$ and, for example,

$$\begin{aligned} \rho_2(1, t)/\rho_2(0, t) &= \frac{1}{2} |t|_{01}, \\ \rho_2(2, t)/\rho_2(0, t) &= -\frac{1}{8} |t|_{01} + |t|_{011} + \frac{1}{4} |t|_{001} + \frac{1}{8} |t|_{01}^2. \end{aligned}$$

In general, if we denote by \bar{w} the Boolean complement of the word $w \in W$, these expressions are obtained by inserting the value $|t|_{\bar{w}}$ for the variable X_w in P_j (compare to (188)):

$$t \mapsto (|t|_{\bar{w}})_{w \in W_j} \mapsto P_j\left((|t|_{\bar{w}})_{w \in W_j}\right) = \frac{\rho_2(j, t)}{\rho_2(0, t)}.$$

9.7 PROOFS

Proof of Proposition 9.3.1. Assume that P_j and \tilde{P}_j are two polynomials in the variables X_w ($w \in W$), representing $\vartheta(j, n)/\vartheta(0, n)$, and let R be the maximal degree with which a variable X_w occurs in P_j or \tilde{P}_j . Moreover, let ℓ be such that $\ell + 1$ is the maximal length of a word w such that the variable X_w occurs in one of the polynomials. The strategy is to compute the coefficients of a polynomial starting from its values. For a multivariate polynomial in M variables, where the degree of each variable is bounded by R , this can be done by evaluating the polynomial at each tuple in $\{0, \dots, R\}^M$, and applying recursively the fact that a univariate polynomial q is determined by $\deg q + 1$ of its values. We adapt this strategy, taking the dependence between the variables into account.

On the set W_ℓ we have a partial order \preceq defined by $v \preceq w$ if and only if v is a factor of w . For convenience, we extend this order to a total order on W_ℓ and denote it the same symbol \preceq . Let w_0, \dots, w_{M-1} be the increasing enumeration of W_ℓ (where $M = |W_\ell|$). We will work with certain “test integers”, defined as follows. For a vector

2 In [68], the authors use the notations $\delta(j, t) = \text{dens}\{m \geq 0 : s_2(m+t) - s_2(m) = j\}$ for all $j \in \mathbb{Z}$, and $b_{2^j} = \text{dens}\{m : 2^j \nmid \binom{m+t}{m}\}$. We have $\rho_2(j, t) = \delta(s_2(t) - j, t)$ for all $j \geq 0$ and $b_{2^j}(t) = \rho_2(0, t) + \dots + \rho_2(j-1, t)$ for $j \geq 1$.

$a = (a_m)_{m < M}$ in $\{0, \dots, R\}^M$ let $n(a)$ be the integer whose binary expansion is given by the concatenation $v_{M-1} \cdots v_0$, where

$$v_m = \left(w_m q^\ell 0^\ell \right)^{a_m} \left(q^\ell 0^\ell \right)^{R-a_m}.$$

The idea behind this is that $q^\ell 0^\ell$ acts as a “separator” in the sense that admissible factors of length $\leq \ell + 1$ are contained completely in one of the building blocks $w_m q^\ell 0^\ell$ or $q^\ell 0^\ell$. (At this point the restrictions $w_{v-1} \neq 0, w_0 \neq q$ for a word $w_{v-1} \cdots w_0 \in W$ come into play.) By varying the values a_m we can therefore vary the factor count $|\cdot|_{w_m}$ without changing $|\cdot|_{w_{m'}}$ for $m' > m$. For simplicity, we rename the variables X_{w_m} to X_m . We prove the following statement by induction on s .

Claim. *Assume that $s \in [0, M]$. Then, for all $a_0, \dots, a_{M-1}, k_0, \dots, k_{s-1} \in \{0, \dots, R\}$ we have*

$$\left[X_0^{k_0} \cdots X_{s-1}^{k_{s-1}} \right] \left(P_j - \tilde{P}_j \right) \left(X_0, \dots, X_{s-1}, |n(a)|_{w_s}, \dots, |n(a)|_{w_{M-1}} \right) = 0.$$

The case $s = 0$ follows from the assumption that P_j and \tilde{P}_j yield the same value for all assignments $X_w = |n|_w$, where $n \geq 0$. The case $s = M$ is the desired statement that $P_j = \tilde{P}_j$, by the fact that the degree of each variable in P_j and \tilde{P}_j is bounded by R . Assume therefore that the statement holds for some $s < M$ and let $a_0, \dots, a_{M-1}, k_0, \dots, k_{s-1} \in \{0, \dots, R\}$. We define polynomials $Q(X_s)$ and $\tilde{Q}(X_s)$ in one variable, of degree at most R , by

$$Q(X_s) = \left[X_0^{k_0} \cdots X_{s-1}^{k_{s-1}} \right] P_j \left(X_0, \dots, X_s, |n(a)|_{w_{s+1}}, \dots, |n(a)|_{w_{M-1}} \right),$$

analogously \tilde{Q} . By the definition of the total order \preceq we have

$$|n(a^{(r)})|_{w_m} = |n(a)|_{w_m}$$

for $0 \leq r \leq R$ and $m > s$, where

$$a_\ell^{(r)} = \begin{cases} a_\ell, & \ell \neq s; \\ r, & \ell = s. \end{cases}$$

By the induction hypothesis for $a^{(0)}, \dots, a^{(R)}$, we obtain the equality $Q(N) = \tilde{Q}(N)$ for the $R + 1$ values $|n(a^{(0)})|_{w_s}, \dots, |n(a^{(R)})|_{w_s}$ of N , therefore

$$\begin{aligned} 0 &= \left[X_s^{k_s} \right] (Q - \tilde{Q})(X_s) \\ &= \left[X_0^{k_0} \cdots X_s^{k_s} \right] \left(P_j - \tilde{P}_j \right) \left(X_0, \dots, X_s, |n(a)|_{w_{s+1}}, \dots, |n(a)|_{w_{M-1}} \right). \end{aligned}$$

This proves that $P_j = \tilde{P}_j$. □

Proof of Proposition 9.3.2. Let $v \in W \cup \{\varepsilon\}$. The proof is by induction on the length of v , the case $v = \varepsilon$ being trivial. Moreover, for the words $c0^s a$, where $c \in \{1, \dots, q\}$, $s \geq 0$ and $a \in \{0, \dots, q-1\}$, we obtain

$$\prod_{w \in W} \left(\frac{\bar{T}_w \bar{T}_{w_{LR}}}{\bar{T}_{w_R} \bar{T}_{w_L}} \right)^{|v|_w} = \frac{\bar{T}_{c0^s a}}{\bar{T}_{c0^s}} \cdot \frac{\bar{T}_{c0^s}}{\bar{T}_{c0^{s-1}}} \cdots \frac{\bar{T}_{c0}}{\bar{T}_\varepsilon} = \bar{T}_{c0^s a}.$$

Suppose that the statement holds for some $v' \in W$. It is sufficient to show that it is also true for $v = a0^s v'$, where $a \in \{1, \dots, q\}$ and $s \geq 0$.

Since words in W do not end with the letter 0, an admissible factor of v is either a factor of v' or a suffix of v . This implies that the product corresponding to v is obtained from the product corresponding to v' , multiplying by $\bar{T}_w \bar{T}_{w_{LR}} / (\bar{T}_{w_R} \bar{T}_{w_L})$ for each suffix (read from right to left) w of v such that $w \in W$. This product of suffixes equals

$$\prod_{\substack{w \text{ suffix of } v \\ w \in W}} \frac{\bar{T}_w \bar{T}_{w_{LR}}}{\bar{T}_{w_R} \bar{T}_{w_L}} = \prod_{\substack{w \text{ suffix of } v \\ w \in W}} \frac{\bar{T}_w}{\bar{T}_{w_R}} \prod_{\substack{w \text{ suffix of } v' \\ w \in W}} \frac{\bar{T}_{w_R}}{\bar{T}_w} = \frac{\bar{T}_v}{\bar{T}_{v'}}.$$

This shows the desired form and together with the induction hypothesis it yields the claim. \square

Finally, we prove Proposition 9.3.6 by a somewhat tedious case distinction.

Proof of Proposition 9.3.6. Assume $w = w_{v-1} \cdots w_0 \in W$. The statement we want to prove is equivalent to

$$\bar{T}_w \bar{T}_{w_{LR}} - \bar{T}_{w_L} \bar{T}_{w_R} = \alpha x^{v-1}, \tag{212}$$

where

$$\alpha = p^{v-2} \frac{w_{v-1}}{w_{v-1} + 1} \frac{p - w_0 - 1}{w_0 + 1} \prod_{2 \leq d \leq p} d^{-2|w'|_{d-1}},$$

and w' is obtained from w by omitting the left- and rightmost digits. We want to prove the statement by induction on the *right depth* of $w \in W$. This is the number of right truncations needed to map w to a *base case*, which are words v such that $v_{LR} = \varepsilon$. Among the base cases there are words v satisfying $v_L = \varepsilon$. These are exactly the words of the form $c0^t a$, for $c \neq 0$, $t \geq 0$ and $a \neq q$. The remaining base cases fall into exactly one of the following classes, where $c \in \{1, \dots, q\}$ and $a \in \{0, \dots, q-1\}$.

- $v = cq^s a$ with $s \geq 1$;
- $v = cbq^s a$ with $b \notin \{0, q\}$ and $s \geq 0$;
- $v = c0^t bq^s a$ with $t \geq 1$, $b \notin \{0, q\}$ and $s \geq 0$;
- $v = c0^t q^s a$ with $t \geq 1$ and $s \geq 1$.

We begin with the following formulae, which can be proved from the recurrence (198) in a straightforward way, and which we will use throughout this proof. Assume that $w = \{0, \dots, q\}^*$, $s \geq 1$, $t \geq 0$, $c \in \{1, \dots, q\}$, and $a \in \{0, \dots, q-1\}$. Then

$$T_{wq^s a}(x) = p^s \left((a+1) + (p-a-1)(p-1) \sum_{1 \leq i < s} (x/p)^i \right) T_w(x) + (p-a-1)x^s T_{w(q-1)}(x), \quad (213)$$

$$T_{wc0^t a}(x) = \frac{1}{p} \left((p-a-1)(px)^{t+1} + (a+1)(p-1) \sum_{1 \leq i \leq t} (px)^i \right) \times T_{w(c-1)}(x) + (a+1)T_{wc}(x). \quad (214)$$

We note the following special case of (214):

$$T_{ca} = (c+1)(a+1) + c(p-a-1)x. \quad (215)$$

We proceed to evaluating $\bar{T}_w \bar{T}_{w_{LR}} - \bar{T}_{w_L} \bar{T}_{w_R}$ for the base cases, thus confirming (212) for these cases. If $w = ca$, $c \neq 0$, and $a \neq q$, we have $\bar{T}_w \bar{T}_{w_{LR}} - \bar{T}_{w_L} \bar{T}_{w_R} = \bar{T}_w - 1 = \frac{c}{c+1} \frac{p-a-1}{a+1} x$ by (215). If $w = cq^s a$, where $s \geq 1$, $c \neq 0$, and $a \neq q$, we obtain by (213) and (215)

$$\begin{aligned} \bar{T}_{cq^s a}(x) &= 1 + \frac{p-a-1}{a+1} (p-1) \left((x/p)^1 + \dots + (x/p)^s \right) \\ &\quad + (x/p)^s \frac{c}{c+1} \frac{p-a-1}{a+1} x, \\ \bar{T}_{q^s a}(x) &= 1 + \frac{p-a-1}{a+1} (p-1) \left((x/p)^1 + \dots + (x/p)^s \right), \end{aligned}$$

therefore

$$\bar{T}_w \bar{T}_{w_{LR}} - \bar{T}_{w_L} \bar{T}_{w_R} = \bar{T}_{cq^s a}(x) - \bar{T}_{q^s a}(x) = x^{s+1} p^{-s} \frac{c}{c+1} \frac{p-a-1}{a+1}.$$

If $w = c0^t a$, where $t \geq 1$, $c \in \{1, \dots, q\}$, and $a \in \{0, \dots, q-1\}$, we obtain by (214)

$$\begin{aligned} \bar{T}_{c0^t a}(x) &= 1 + \frac{p-a-1}{a+1} \frac{c}{c+1} p^t x^{t+1} + \frac{p-1}{p} \frac{c}{c+1} (px + \dots + (px)^t), \\ \bar{T}_{c0^t}(x) &= 1 + \frac{p-1}{p} \frac{c}{c+1} \left((px)^1 + \dots + (px)^t \right), \end{aligned}$$

therefore

$$\bar{T}_w \bar{T}_{w_{LR}} - \bar{T}_{w_L} \bar{T}_{w_R} = p^t x^{t+1} \frac{p-a-1}{a+1} \frac{c}{c+1}.$$

Now let $w = cbq^s a$ for some $c \neq 0$, $b \in \{1, \dots, q-1\}$, $s \geq 0$, and $a \neq q$. The case $s = 0$ can be verified easily: after a short calculation we obtain the expected result

$$\bar{T}_{cba} - \bar{T}_{ba} \bar{T}_{cb} = \frac{c}{c+1} \frac{p}{(b+1)^2} \frac{p-a-1}{a+1} x^2.$$

Otherwise we get by (213):

$$\begin{aligned}
 (b+1)T_w T_{w_{LR}} - T_{w_L} T_{w_R} &= (b+1)T_{cbq^s a} - T_{bq^s a} T_{cb} \\
 &= (b+1) \left(p^s ((a+1) + (p-a-1)(p-1)) \times \right. \\
 &\quad \left. ((x/p)^1 + \dots + (x/p)^{s-1}) T_{cb} + (p-a-1)x^s T_{cb(q-1)} \right) \\
 &\quad - \left(p^s ((a+1) + (p-a-1)(p-1)) ((x/p)^1 + \dots + (x/p)^{s-1}) T_b \right. \\
 &\quad \left. + (p-a-1)x^s T_{b(q-1)} \right) T_{cb} \\
 &= (p-a-1)x^s \left((b+1)T_{cb(q-1)} - T_{b(q-1)} T_{cb} \right).
 \end{aligned}$$

Using the case $s = 0$, we obtain

$$\begin{aligned}
 \bar{T}_w \bar{T}_{w_{LR}} - \bar{T}_{w_L} \bar{T}_{w_R} &= \frac{p-a-1}{a+1} (p-1) p^{-s} x^s (\bar{T}_{cb(q-1)} - \bar{T}_{b(q-1)} \bar{T}_{cb}) \\
 &= \frac{c}{c+1} \frac{1}{(b+1)^2} \frac{p-a-1}{a+1} p^{-s+1} x^{s+2}.
 \end{aligned}$$

Let $w = c0^t b q^s a$, where $c \neq 0$, $t \geq 1$, $b \notin \{0, q\}$, $s \geq 0$, and $a \neq q$. If $s = 0$, we obtain by (215) and (214)

$$\begin{aligned}
 (b+1)T_w T_{w_{LR}} - T_{w_L} T_{w_R} &= (b+1)T_{c0^t b a} - T_{b a} T_{c0^t b} \\
 &= (b+1) \left((a+1)T_{c0^t b} + (p-a-1)x T_{c0^t(b-1)} \right) \\
 &\quad - \left((b+1)(a+1) + b(p-a-1)x \right) T_{c0^t b} \\
 &= (b+1)(p-a-1)x \left(\frac{1}{p} \left((p-b)(px)^{t+1} \right. \right. \\
 &\quad \left. \left. + b(p-1) \sum_{1 \leq i \leq t} (px)^i \right) T_{c-1} + b T_c \right) \\
 &\quad - b(p-a-1)x \left(\frac{1}{p} \left((p-b-1)(px)^{t+1} \right. \right. \\
 &\quad \left. \left. + (b+1)(p-1) \sum_{1 \leq i \leq t} (px)^i \right) T_{c-1} + (b+1)T_c \right) \\
 &= (p-a-1)p^{t+1} x^{t+2} c.
 \end{aligned}$$

Therefore we get in this case

$$\bar{T}_w \bar{T}_{w_{LR}} - \bar{T}_{w_L} \bar{T}_{w_R} = p^{t+1} x^{t+2} \frac{c}{c+1} \frac{1}{(b+1)^2} \frac{p-a-1}{a+1}.$$

If $s \geq 1$, we obtain, using (213)–(215),

$$\begin{aligned}
(b+1)T_w T_{w_{LR}} - T_{w_L} T_{w_R} &= (b+1)T_{c_0^t b q^s a} - T_{b q^s a} T_{c_0^t b} \\
&= (b+1) \left(p^s \left((a+1) + (p-a-1)(p-1) \sum_{1 \leq i < s} (x/p)^i \right) T_{c_0^t b} \right. \\
&\quad \left. + (p-a-1)x^s T_{c_0^t b(q-1)} \right) \\
&\quad - \left(p^s \left((a+1) + (p-a-1)(p-1) \sum_{1 \leq i < s} (x/p)^i \right) T_b \right. \\
&\quad \left. + (p-a-1)x^s T_{b(q-1)} \right) T_{c_0^t b} \\
&= (p-a-1)x^s \left((b+1)T_{c_0^t b(q-1)} - T_{b(q-1)} T_{c_0^t b} \right) \\
&= (p-a-1)x^s \left((b+1) \left((p-1)T_{c_0^t b} + xT_{c_0^t(b-1)} \right) \right. \\
&\quad \left. - \left((b+1)(p-1) + bx \right) T_{c_0^t b} \right) \\
&= (p-a-1)x^{s+1} \left((b+1)T_{c_0^t(b-1)} - bT_{c_0^t b} \right) \\
&= (p-a-1)(b+1)x^{s+1} \left(\frac{1}{p} \left((p-b)(px)^{t+1} \right. \right. \\
&\quad \left. \left. + b(p-1) \sum_{1 \leq i \leq t} (px)^i \right) T_{c-1} + bT_c \right) \\
&\quad - (p-a-1)bx^{s+1} \left(\frac{1}{p} \left((p-b-1)(px)^{t+1} \right. \right. \\
&\quad \left. \left. + (b+1)(p-1) \sum_{1 \leq i \leq t} (px)^i \right) T_{c-1} + (b+1)T_c \right) \\
&= (p-a-1)p^{t+1}x^{s+t+2}c,
\end{aligned}$$

which yields the statement also for this case.

We proceed with the case $w = c0^tq^sa$, where $c \neq 0$, $t, s \geq 1$, and $a \neq q$. In this case, we have

$$\begin{aligned}
T_w T_{w_{LR}} - T_{w_L} T_{w_R} &= T_{c0^tq^sa} - T_{q^sa} T_{c0^t} \\
&= \left(p^s \left((a+1) + (p-a-1)(p-1) \sum_{1 \leq i < s} (x/p)^i \right) T_{c0^t} \right. \\
&\quad \left. + (p-a-1)x^s T_{c0^t(q-1)} \right) \\
&\quad - \left(p^s \left((a+1) + (p-a-1)(p-1) \sum_{1 \leq i < s} (x/p)^i \right) \right. \\
&\quad \left. + (p-a-1)x^s T_{q-1} \right) T_{c0^t} \\
&= (p-a-1)x^s (T_{c0^t(q-1)} - (p-1)T_{c0^t}) \\
&= (p-a-1)x^s \left(((p-1)T_{c0^t} + x^{t+1}T_{(c-1)q^t}) - (p-1)T_{c0^t} \right) \\
&= (p-a-1)p^t c x^{s+t+1},
\end{aligned}$$

therefore

$$\bar{T}_w \bar{T}_{w_{LR}} - \bar{T}_{w_L} \bar{T}_{w_R} = p^{t-s} x^{s+t+1} \frac{c}{c+1} \frac{p-a-1}{a+1}.$$

Equation (212) therefore holds for the base cases. Assume that we have already established the statement for all $w \in W$ having right depth $\leq d-1$, where $d \geq 1$, and assume that $\tilde{w} \in W$ has right depth equal to d . Then \tilde{w} is of (exactly) one of the following forms, which we have to treat one by one.

$$wb0, \quad w0 \in W, b \in \{1, \dots, q-1\}; \quad (216)$$

$$wb0^t, \quad w0 \in W, b \in \{1, \dots, q\}, t \geq 2; \quad (217)$$

$$wq^s a, \quad w \in W, s \geq 1, a \in \{0, \dots, q-1\}; \quad (218)$$

$$wa, \quad w \in W, a \in \{1, \dots, q-1\}. \quad (219)$$

We will use the following auxiliary formulae. If $wb \in W$, where $b \neq 0$ and $(wb)_L \neq \varepsilon$, then

$$\begin{aligned}
b(b+1) \left(\bar{T}_{(wb)-1} \bar{T}_{(wb)_L} - \bar{T}_{(wb)_L-1} \bar{T}_{wb} \right) &= \\
&= \frac{p}{p-1} \left(\bar{T}_{w0} \bar{T}_{(w0)_{LR}} - \bar{T}_{(w0)_L} \bar{T}_{(w0)_R} \right). \quad (220)
\end{aligned}$$

If moreover $w = w_{v-1} \cdots w_r 0^r \in W$, where $r \geq 0$ is maximal, and $w_L \neq \varepsilon$ is satisfied, we have

$$x^{r+1} \left(T_{w-1} T_{w_L} - T_{w_{L-1}} T_w \right) = \frac{1}{p-1} \left(T_{w0} T_{(w0)_{LR}} - T_{(w0)_L} T_{(w0)_R} \right). \quad (221)$$

Let us now prove these formulae. We handle the case $w_L = \varepsilon$ separately. Since $(wb)_L \neq \varepsilon$ by assumption, there exist $d \in \{1, \dots, q\}$,

$c \in \{1, \dots, q-1\}$ and $t \geq 0$ such that $w = d0^t c$. We obtain by (215) and (214)

$$\begin{aligned}
& T_{(wb)^{-1}} T_{(wb)_L} - T_{(wb)_L^{-1}} T_{wb} \\
&= T_{d0^t c(b-1)} T_{cb} - T_{c(b-1)} T_{d0^t cb} \\
&= \left(bT_{d0^t c} + (p-b)xT_{d0^t(c-1)} \right) \left((c+1)(b+1) + c(p-b-1)x \right) \\
&\quad - \left((c+1)b + c(p-b)x \right) \left((b+1)T_{d0^t c} + (p-b-1)xT_{d0^t(c-1)} \right) \\
&= px \left((c+1)T_{d0^t(c-1)} - cT_{d0^t c} \right) \\
&= px \left((c+1) \left(\frac{1}{p} \left((p-c)(px)^{t+1} + c(p-1) \sum_{1 \leq i \leq t} (px)^i \right) T_{d-1} + cT_d \right) \right. \\
&\quad \left. - c \left(\frac{1}{p} \left((p-c-1)(px)^{t+1} + (c+1)(p-1) \sum_{1 \leq i \leq t} (px)^i \right) T_{d-1} \right. \right. \\
&\quad \left. \left. + (c+1)T_d \right) \right) \\
&= p^{t+2} x^{t+2} d,
\end{aligned}$$

moreover

$$\begin{aligned}
& (c+1)T_{w0} T_{(w0)_{LR}} - T_{(w0)_L} T_{(w0)_R} \\
&= (c+1)T_{d0^t c0} - T_{c0} T_{d0^t c} \\
&= (c+1)(T_{d0^t c} + (p-1)xT_{d0^t(c-1)}) - ((c+1) + c(p-1)x)T_{d0^t c} \\
&= (p-1)x((c+1)T_{d0^t(c-1)} - cT_{d0^t c}) \\
&= (p-1)x \left((c+1) \left(\frac{1}{p} \left((p-c)(px)^{t+1} + c(p-1) \sum_{1 \leq i \leq t} (px)^i \right) d \right. \right. \\
&\quad \left. \left. + c(d+1) \right) \right. \\
&\quad \left. - c \left(\frac{1}{p} \left((p-c-1)(px)^{t+1} + (c+1)(p-1) \sum_{1 \leq i \leq t} (px)^i \right) d \right. \right. \\
&\quad \left. \left. + (c+1)(d+1) \right) \right) \\
&= (p-1)p^{t+1} x^{t+2} d.
\end{aligned}$$

Passing from T to \bar{T} , we obtain the statement (220) for the case $w_L = \varepsilon$, $(wb)_L \neq \varepsilon$. If $w_L \neq \varepsilon$, we have $(wb)_L = w_L b$, moreover r is also the number of zeros at the low digits of w_L . Therefore

$$\begin{aligned}
& T_{(wb)^{-1}} T_{(wb)_L} - T_{(wb)_L^{-1}} T_{wb} \\
&= (bT_w + (p-b)x^{r+1}T_{w-1}) \left((b+1)T_{w_L} + (p-b-1)x^{r+1}T_{w_L-1} \right) \\
&\quad - (bT_{w_L} + (p-b)x^{r+1}T_{w_L-1}) \left((b+1)T_w + (p-b-1)x^{r+1}T_{w-1} \right) \\
&= px^{r+1} (T_{w-1} T_{w_L} - T_{w_L-1} T_w),
\end{aligned}$$

and (220) and (221) follow easily using the instance $T_{w0} = T_w + (p-1)x^{r+1}T_{w-1}$ of the recurrence (198). We have to treat the cases (216)–(219). Assume that $\tilde{w} = wb0$, where $w0 \in W$ and $b \in \{1, \dots, q-1\}$.

Since $(wb)_L = \tilde{w}_{RL} \neq \varepsilon$ (this holds since the right depth of \tilde{w} is not zero), we have $\tilde{w}_L = (wb)_L 0$ and therefore

$$\begin{aligned} T_{\tilde{w}} T_{\tilde{w}_{LR}} - T_{\tilde{w}_L} T_{\tilde{w}_R} &= T_{wb0} T_{(wb)_L} - T_{(wb)_L 0} T_{wb} \\ &= (T_{wb} + (p-1)x T_{(wb)_{-1}}) T_{(wb)_L} - (T_{(wb)_L} + (p-1)x T_{(wb)_{L-1}}) T_{wb} \\ &= (p-1)x (T_{(wb)_{-1}} T_{(wb)_L} - T_{(wb)_{L-1}} T_{wb}). \end{aligned}$$

By (220) we have

$$\begin{aligned} \bar{T}_{\tilde{w}} \bar{T}_{\tilde{w}_{LR}} - \bar{T}_{\tilde{w}_L} \bar{T}_{\tilde{w}_R} &= (p-1)x \frac{b}{b+1} (\bar{T}_{(wb)_{-1}} \bar{T}_{(wb)_L} - \bar{T}_{(wb)_{L-1}} \bar{T}_{wb}) \\ &= \frac{px}{(b+1)^2} (\bar{T}_{w0} \bar{T}_{(w0)_{LR}} - \bar{T}_{(w0)_L} \bar{T}_{(w0)_R}). \end{aligned}$$

Since the right depth of $w0$ is smaller than d , we can apply the induction hypothesis and the case (216) is finished. Now we assume that $\tilde{w} = wb0^t$, where $w0 \in W$, $b \in \{1, \dots, q\}$, and $t \geq 2$. We first note that for a finite word $v \in \{0, \dots, q\}^*$ we have the identity $T_{vb0^t} = T_{vb0^{t-1}} + (p-1)x^t T_{vb0^{t-1-1}} = T_{vb0^{t-1}} + (p-1)x^t p^{t-1} T_{v(b-1)}$, analogously for $t-1$ instead of t , therefore

$$T_{vb0^t} = (1+px)T_{vb0^{t-1}} - pxT_{vb0^{t-2}}.$$

Moreover, we also have $\tilde{w}_L = (wb0)_L 0^{t-1} = w'b0^t$ for some $w' \in \{0, \dots, q\}^*$. We may therefore calculate:

$$\begin{aligned} T_{\tilde{w}} T_{\tilde{w}_{LR}} - T_{\tilde{w}_L} T_{\tilde{w}_R} &= \left((1+px)T_{wb0^{t-1}} - pxT_{wb0^{t-2}} \right) T_{w'b0^{t-1}} \\ &\quad - \left((1+px)T_{w'b0^{t-1}} - pxT_{w'b0^{t-2}} \right) T_{wb0^{t-1}} \\ &= px (T_{wb0^{t-1}} T_{w'b0^{t-2}} - T_{(wb0^{t-1})_L} T_{(wb0^{t-1})_R}). \end{aligned}$$

If $t > 2$ or $(wb)_L \neq \varepsilon$, we have $w'b0^{t-2} = (wb0^{t-1})_{LR}$, therefore

$$\bar{T}_{\tilde{w}} \bar{T}_{\tilde{w}_{LR}} - \bar{T}_{\tilde{w}_L} \bar{T}_{\tilde{w}_R} = px (\bar{T}_{wb0^{t-1}} \bar{T}_{(wb0^{t-1})_{LR}} - \bar{T}_{(wb0^{t-1})_L} \bar{T}_{(wb0^{t-1})_R})$$

and we can use the induction hypothesis. Otherwise, we have $w = d0^r$ for some $d \in \{1, \dots, q\}$ and $r \geq 0$, and we obtain

$$\begin{aligned} \bar{T}_{\tilde{w}} \bar{T}_{\tilde{w}_{LR}} - \bar{T}_{\tilde{w}_L} \bar{T}_{\tilde{w}_R} &= \frac{1}{(d+1)(b+1)^2} (T_{\tilde{w}} T_{\tilde{w}_{LR}} - T_{\tilde{w}_L} T_{\tilde{w}_R}) \\ &= \frac{px}{(d+1)(b+1)^2} (T_{wb0} T_b - T_{(wb0)_L} T_{(wb0)_R}) \\ &= px (\bar{T}_{wb0} \bar{T}_\varepsilon - \bar{T}_{(wb0)_L} \bar{T}_{(wb0)_R}) \\ &= px (\bar{T}_{wb0} \bar{T}_{(wb0)_{LR}} - \bar{T}_{(wb0)_L} \bar{T}_{(wb0)_R}), \end{aligned}$$

so that we can apply the hypothesis also in this case. Assume that $\tilde{w} = wq^s a$, where $w = w_{v-1} \cdots w_r 0^r \in W$ and $r \geq 0$ is maximal, $s \geq 1$,

and $a \in \{0, \dots, q-1\}$. The right depth of \tilde{w} is at least one. Therefore $w_L \neq \varepsilon$, and we obtain, using (213) and (221),

$$\begin{aligned}
& T_{\tilde{w}} T_{\tilde{w}_{LR}} - T_{\tilde{w}_L} T_{\tilde{w}_R} \\
&= \left(p^s \left((a+1) + (p-a-1)(p-1) \sum_{1 \leq i < s} (x/p)^i \right) T_w \right. \\
&\quad \left. + (p-a-1)x^s T_{w(q-1)} \right) T_{w_L} \\
&\quad - \left(p^s \left((a+1) + (p-a-1)(p-1) \sum_{1 \leq i < s} (x/p)^i \right) T_{w_L} \right. \\
&\quad \left. + (p-a-1)x^s T_{w_L(q-1)} \right) T_w \\
&= (p-a-1)x^s (T_{w(q-1)} T_{w_L} - T_{w_L(q-1)} T_w) \\
&= (p-a-1)x^s \left(((p-1)T_w + x^{r+1}T_{w-1}) T_{w_L} \right. \\
&\quad \left. - ((p-1)T_{w_L} + x^{r+1}T_{w_L-1}) T_w \right) \\
&= (p-a-1)x^{s+r+1} (T_{w-1} T_{w_L} - T_{w_L-1} T_w) \\
&= (p-a-1) \frac{1}{p-1} x^r (T_{w0} T_{(w0)_{LR}} - T_{(w0)_L} T_{(w0)_R}),
\end{aligned}$$

therefore

$$\bar{T}_{\tilde{w}} \bar{T}_{\tilde{w}_{LR}} - \bar{T}_{\tilde{w}_L} \bar{T}_{\tilde{w}_R} = \frac{p-a-1}{a+1} \frac{1}{p-1} p^{-r} x^r (\bar{T}_{w0} \bar{T}_{(w0)_{LR}} - \bar{T}_{(w0)_L} \bar{T}_{(w0)_R}).$$

Now one of the two cases (216) or (217) is applicable. It remains to deal with the fourth case. Assume that $\tilde{w} = wa$, where $w = w_{v-1} \cdots w_r 0^r \in W$ and $r \geq 0$ is maximal, and $a \in \{1, \dots, q-1\}$. As in the last case, we have $w_L \neq \varepsilon$, therefore we can use (221) and obtain

$$\begin{aligned}
T_{\tilde{w}} T_{\tilde{w}_{LR}} - T_{\tilde{w}_L} T_{\tilde{w}_R} &= ((a+1)T_w + (p-a-1)x^{r+1}T_{w-1}) T_{w_L} \\
&\quad - ((a+1)T_{w_L} + (p-a-1)x^{r+1}T_{w_L-1}) T_w \\
&= (p-a-1)x^{r+1} (T_{w-1} T_{w_L} - T_{w_L-1} T_w) \\
&= \frac{p-a-1}{p-1} (T_{w0} T_{(w0)_{LR}} - T_{(w0)_L} T_{(w0)_R}),
\end{aligned}$$

therefore

$$\bar{T}_{\tilde{w}} \bar{T}_{\tilde{w}_{LR}} - \bar{T}_{\tilde{w}_L} \bar{T}_{\tilde{w}_R} = \frac{p-a-1}{a+1} \frac{1}{p-1} (T_{w0} T_{(w0)_{LR}} - T_{(w0)_L} T_{(w0)_R}).$$

As in the previous case, this expression can be treated with one of the cases (216) or (217). The proof is complete. \square

Part V

APPENDIX

NOTATION

$n!$	factorial of a non-negative integer n $0! = 1, n! = n \cdot (n - 1)! = n(n - 1) \cdot 1$
$\Gamma(z)$	Gamma function: $\Gamma(z) = \int_0^\infty t^{z-1} e^{-t} dt$ $\Gamma(n) = (n - 1)!$ for a non-negative integer n
$\alpha^{\underline{k}}$	falling factorial of α for a real α and a non-negative k : $\alpha^{\underline{0}} = 1, \alpha^{\underline{k}} = \alpha \cdot (\alpha - 1)^{\underline{k-1}} = \alpha(\alpha - 1) \cdot (\alpha - k + 1)$
$\binom{\alpha}{k}$	binomial coefficient for real α and non-negative k : $\binom{\alpha}{k} = \frac{\alpha^{\underline{k}}}{k!}, \text{ for } n \in \mathbb{N} : \binom{n}{k} = \frac{n!}{(n - k)!k!}$
$\mathbb{P}[X]$	probability of X
$\mathbb{E}(X)$	expected value of X
$\mathbb{V}(X)$	variance of X
$ T $	size of the combinatorial object T

REFLECTION-ABSORPTION MODEL

Let c, d, c_0, d_0 be positive integers. The jump polynomial for altitude $k \neq 0$ is equal to

$$P(u) = \sum_{i=-c}^d p_i u^i,$$

whereas the jump polynomial for altitude $k = 0$ is given by

$$P_0(u) = \sum_{i=-c_0}^{d_0} p_{0,i} u^i.$$

The weights p_i and $p_{0,i}$ are probabilities, i.e. $p_i, p_{0,i} \in [0, 1]$ such that $\sum_{i=-c}^d p_i = \sum_{i=-c_0}^{d_0} p_{0,i} = 1$. $P^{\geq}(u)$ and $P_0^{\geq}(u)$ denote the non-zero parts of $P(u)$ and $P_0(u)$, respectively.

Furthermore, during the discussion of Łukasiewicz bridges in Section 4.3 the following expression was introduced, which plays a similar role as $P_0^{\geq}(u)$ for excursions:

$$Q(u) = P_0^{\geq}(u) + \frac{p_{0,-1}}{p_{-1}} u (P^{\geq})'(u).$$

Table 25 summarizes the used constants and gives the location of their first appearance.

Constant	Definition	Description	First Appearance
τ	$P'(\tau) = 0, \tau > 0$	structural constant	[19] and Equation (73)
ρ	$\frac{1}{P(\tau)}$	structural radius	[19] and Equation (73)
ρ_1	$1 - \rho_1 P_0^\geq(u_1(\rho_1)) = 0$	unique sol. in supercr. case	Lemma 4.2.1
ρ_0^\geq	$\frac{1}{P_0^\geq(\tau)}$	structural reflection radius	Remark 11
ρ_B	$1 - \rho_B Q(u_1(\rho_B)) = 0$	unique sol. for bridge equation	Lemma 4.3.3
λ	$\frac{P_0^\geq(\tau)}{P(\tau)} = \frac{\rho}{\rho_0^\geq}$	arch constant	Proposition 4.2.4
λ_B	$\frac{P_0(\tau)}{P(\tau)}$	general arch constant	Proposition 4.3.7
δ	$P'(1)$	drift	[19] and Section 4.4
δ_0^\geq	$(P_0^\geq)'(1)$	drift at 0	Section 4.4
C	$\sqrt{2 \frac{P(\tau)}{P'(\tau)}}$	square root coeff. of u_1 at ρ	Equation (73)
γ	$\frac{1}{\alpha \rho_1^2 + 1}$	supercritical excursion factor	Theorem 4.2.2
γ_B	$\frac{1}{1 + \rho_B^2 Q'(\rho_B)}$	supercritical bridge factor	Theorem 4.3.6
κ	$C \rho (P_0^\geq)'(\tau)$	critical excursion constant	Theorem 4.2.2
κ_B	$C \rho P_0'(\tau) + \frac{\rho_0 - 1}{p-1} \frac{2\tau}{C}$	critical bridge constant	Theorem 4.3.6
α	$(P_0^\geq(u_1(z)))' _{z=\rho_1}$	linear Taylor coefficient at ρ_1	Theorem 4.2.2
α_2	$(P_0^\geq(u_1(z)))'' _{z=\rho_1}$	$\frac{\alpha_2}{2}$ is the quadr. Taylor coeff. at ρ_1	Theorem 4.2.5
a_1	$(P_0^\geq(u_1(z)))' _{z=1}$	linear Taylor coefficient at 1	Lemma 4.6.3
a_2	$(P_0^\geq(u_1(z)))'' _{z=1}$	$\frac{a_2}{2}$ is the quadr. Taylor coeff. at 1	Lemma 4.6.3

Table 25: Used constants in the reflection-absorption model (Chapter 4) and the location of their first appearance.

COEFFICIENT ASYMPTOTICS OF STANDARD FUNCTIONS

388

VI. SINGULARITY ANALYSIS OF GENERATING FUNCTIONS

<i>Function</i>	<i>coefficients</i>
$(1-z)^{3/2}$	$\frac{1}{\sqrt{\pi n^5}} \left(\frac{3}{4} + \frac{45}{32n} + \frac{1155}{512n^2} + O\left(\frac{1}{n^3}\right) \right)$
$(1-z)$	(0)
$(1-z)^{1/2}$	$-\frac{1}{\sqrt{\pi n^3}} \left(\frac{1}{2} + \frac{3}{16n} + \frac{25}{256n^2} + O\left(\frac{1}{n^3}\right) \right)$
$(1-z)^{1/2} L(z)$	$-\frac{1}{\sqrt{\pi n^3}} \left(\frac{1}{2} \log n + \frac{\gamma + 2 \log 2 - 2}{2} + O\left(\frac{\log n}{n}\right) \right)$
$(1-z)^{1/3}$	$-\frac{1}{3\Gamma(\frac{2}{3})n^{4/3}} \left(1 + \frac{2}{9n} + \frac{7}{81n^2} + O\left(\frac{1}{n^3}\right) \right)$
$z/L(z)$	$\frac{1}{n \log^2 n} \left(-1 + \frac{2\gamma}{\log n} + \frac{\pi^2 - 6\gamma^2}{2 \log^2 n} + O\left(\frac{1}{\log^3 n}\right) \right)$
1	(0)
$\log(1-z)^{-1}$	$\frac{1}{n}$
$\log^2(1-z)^{-1}$	$\frac{1}{n} \left(2 \log n + 2\gamma - \frac{1}{n} - \frac{1}{6n^2} + O\left(\frac{1}{n^4}\right) \right)$
$(1-z)^{-1/3}$	$\frac{1}{\Gamma(\frac{1}{3})n^{2/3}} \left(1 + O\left(\frac{1}{n}\right) \right)$
$(1-z)^{-1/2}$	$\frac{1}{\sqrt{\pi n}} \left(1 - \frac{1}{8n} + \frac{1}{128n^2} + \frac{5}{1024n^3} + O\left(\frac{1}{n^4}\right) \right)$
$(1-z)^{-1/2} L(z)$	$\frac{1}{\sqrt{\pi n}} \left(\log n + \gamma + 2 \log 2 - \frac{\log n + \gamma + 2 \log 2}{8n} + O\left(\frac{\log n}{n^2}\right) \right)$
$(1-z)^{-1}$	1
$(1-z)^{-1} L(z)$	$\log n + \gamma + \frac{1}{2n} - \frac{1}{12n^2} + \frac{1}{120n^4} + O\left(\frac{1}{n^6}\right)$
$(1-z)^{-1} L(z)^2$	$\log^2 n + 2\gamma \log n + \gamma^2 - \frac{\pi^2}{6} + O\left(\frac{\log n}{n}\right)$
$(1-z)^{-3/2}$	$\sqrt{\frac{n}{\pi}} \left(2 + \frac{3}{4n} - \frac{7}{64n^2} + O\left(\frac{1}{n^3}\right) \right)$
$(1-z)^{-3/2} L(z)$	$\sqrt{\frac{n}{\pi}} \left(2 \log n + 2\gamma + 4 \log 2 - 4 + \frac{3 \log n}{4n} + O\left(\frac{1}{n}\right) \right)$
$(1-z)^{-2}$	$n + 1$
$(1-z)^{-2} L(z)$	$n \log n + (\gamma - 1)n + \log n + \frac{1}{2} + \gamma + O\left(\frac{1}{n}\right)$
$(1-z)^{-2} L(z)^2$	$n(\log^2 n + 2(\gamma - 1) \log n + \gamma^2 - 2\gamma + 2) - \frac{\pi^2}{6} + O\left(\frac{\log n}{n}\right)$
$(1-z)^{-3}$	$\frac{1}{2}n^2 + \frac{3}{2}n + 1$

Figure 60: A table from [85, Figure VI.5, p. 388] of some commonly encountered functions and the asymptotic forms of their coefficients. The following abbreviation is used: $L(z) := \log \frac{1}{1-z}$.

BIBLIOGRAPHY

- [1] S. S. Abhyankar. *Algebraic geometry for scientists and engineers*, volume 35 of *Mathematical Surveys and Monographs*. American Mathematical Society, Providence, RI, 1990.
- [2] M. Abramowitz and I. A. Stegun. *Handbook of mathematical functions with formulas, graphs, and mathematical tables*, volume 55 of *National Bureau of Standards Applied Mathematics Series*. For sale by the Superintendent of Documents, U.S. Government Printing Office, Washington, D.C., 1964.
- [3] J. Aebly. Démonstration du problème du scrutin par des considérations géométriques. *Enseign. Math.*, 23:185–186, 1923.
- [4] M. Ahsanullah, B. M. G. Kibria, and M. Shakil. *Normal and Student's t distributions and their applications*, volume 4 of *Atlantis Studies in Probability and Statistics*. Atlantis Press, Paris, 2014.
- [5] J.-P. Allouche and V. Berthé. Triangle de Pascal, complexité et automates. *Bull. Belg. Math. Soc. Simon Stevin*, 4(1):1–23, 1997. Journées Montoises (Mons, 1994).
- [6] J.-P. Allouche and J. Shallit. The ring of k -regular sequences. *Theoret. Comput. Sci.*, 98(2):163–197, 1992.
- [7] J.-P. Allouche and J. Shallit. *Automatic sequences*. Cambridge University Press, Cambridge, 2003. Theory, applications, generalizations.
- [8] T. Amdeberhan and R. P. Stanley. Polynomial Coefficient Enumeration. 2008. Preprint. [arXiv:0811.3652](https://arxiv.org/abs/0811.3652).
- [9] D. André. Solution directe du problème résolu par M. Bertrand. *Comptes Rendus de l'Académie des Sciences*, 105:436–437, 1887.
- [10] D. Armstrong, B. Rhoades, and N. Williams. Rational Catalan combinatorics: the associahedron. *Discrete Math. Theor. Comput. Sci.*, AS:933–944, 2013.
- [11] M. Aumüller, M. Dietzfelbinger, C. Heuberger, D. Krenn, and H. Prodinger. Dual-Pivot Quicksort: Optimality, Analysis and Zeros of Associated Lattice Paths. *arXiv preprint*, [arXiv:1611.00258](https://arxiv.org/abs/1611.00258), 2016. <https://arxiv.org/abs/1611.00258>.
- [12] A. Bacher and N. Beaton. Weakly prudent self-avoiding bridges. *Discrete Mathematics and Theoretical Computer Science*, AT:827–838, 2014. 26th International Conference on Formal Power Se-

- ries and Algebraic Combinatorics (FPSAC 2014), 2014, Chicago (USA).
- [13] C. Banderier. Limit laws for basic parameters of lattice paths with unbounded jumps. In *Mathematics and computer science, II*, Trends Math., pages 33–47. Birkhäuser, 2002.
- [14] C. Banderier. Combinatoire analytique : application aux marches aléatoires. *Mémoire de DEA, INRIA Rocquencourt*, July 1998.
- [15] C. Banderier, O. Bodini, Y. Ponty, and H. T. Bouzid. On the diversity of pattern distributions in rational language. In *ANALCO12—Meeting on Analytic Algorithmics and Combinatorics*, pages 107–115. SIAM, Philadelphia, PA, 2012.
- [16] C. Banderier, M. Bousquet-Mélou, A. Denise, P. Flajolet, D. Gardy, and D. Gouyou-Beauchamps. Generating functions for generating trees. *Discrete Math.*, 246(1-3):29–55, 2002. Formal power series and algebraic combinatorics (Barcelona, 1999).
- [17] C. Banderier and M. Drmota. Formulae and asymptotics for coefficients of algebraic functions. *Combin. Probab. Comput.*, 24(1):1–53, 2015.
- [18] C. Banderier, J.-M. Fédou, C. Garcia, and D. Merlini. Algebraic succession rules and lattice paths with an infinite set of jumps. *Preprint*, pages 1–32, 2003.
- [19] C. Banderier and P. Flajolet. Basic analytic combinatorics of directed lattice paths. *Theoret. Comput. Sci.*, 281(1-2):37–80, 2002.
- [20] C. Banderier, P. Flajolet, G. Schaeffer, and M. Soria. Random maps, coalescing saddles, singularity analysis, and Airy phenomena. *Random Structures & Algorithms*, 19(3-4):194–246, 2001.
- [21] C. Banderier and B. Gittenberger. Analytic combinatorics of lattice paths: enumeration and asymptotics for the area. *Discrete Math. Theor. Comput. Sci. Proc.*, AG:345–355, 2006.
- [22] C. Banderier, C. Krattenthaler, A. Krinik, D. Kruchinin, V. Kruchinin, D. Nguyen, and M. Wallner. Explicit formulas for enumeration of lattice paths: basketball and the kernel method. In *Lattice paths combinatorics and applications*, Developments in Mathematics Series, page Submitted. Springer, 2016.
- [23] C. Banderier and D. Merlini. Algebraic succession rules and lattice paths with an infinite set of jumps. *Proceedings of FPSAC'02*, pages 1–10, 2003.
- [24] C. Banderier and P. Nicodème. Bounded discrete walks. *Discrete Math. Theor. Comput. Sci.*, AM:35–48, 2010.

- [25] C. Banderier and S. Schwer. Why Delannoy numbers? *J. Statist. Plann. Inference*, 135(1):40–54, 2005.
- [26] C. Banderier and M. Wallner. Some reflections on directed lattice paths. In *Proceedings of the 25th International Conference on Probabilistic, Combinatorial and Asymptotic Methods for the Analysis of Algorithms*, pages 25–36, 2014. <http://arxiv.org/abs/1605.01687> (Corrected drift 0 case in Table 4).
- [27] C. Banderier and M. Wallner. Lattice paths of slope $2/5$. In *2015 Proceedings of the Twelfth Workshop on Analytic Algorithmics and Combinatorics (ANALCO)*, pages 105–113. SIAM, Philadelphia, PA, 2015.
- [28] C. Banderier and M. Wallner. The kernel method for lattice paths below a line of rational slope. *Developments in Mathematics Series*, 2016. To appear.
- [29] C. Banderier and M. Wallner. Lattice paths with catastrophes. In *Proceedings of the 10th edition of Génération Aléatoire de Structures COMbinatoires (GASCom 2016)*. Elsevier, 2016. To appear.
- [30] C. Banderier and M. Wallner. The reflection-absorption model for directed lattice paths. In *Proceedings of the Vienna Young Scientists Symposium (VSS)*, pages 98–99, 2016.
- [31] C. Banderier and M. Wallner. Lattice paths below a line of irrational slope. *In preparation*, 2017.
- [32] C. Banderier and M. Wallner. The reflection-absorption model for directed lattice paths. *In preparation*, 2017.
- [33] G. Barat and P. J. Grabner. Distribution of binomial coefficients and digital functions. *J. London Math. Soc. (2)*, 64(3):523–547, 2001.
- [34] D. Barbolosi and P. J. Grabner. Distribution des coefficients multinomiaux et q -binomiaux modulo p . *Indag. Math. (N.S.)*, 7(2):129–135, 1996.
- [35] E. Barcucci, A. Del Lungo, E. Pergola, and R. Pinzani. ECO: a methodology for the enumeration of combinatorial objects. *Journal of Difference Equations and Applications*, 5:435–490, 1999.
- [36] E. A. Bender. Central and local limit theorems applied to asymptotic enumeration. *J. Combinatorial Theory Ser. A*, 15:91–111, 1973.
- [37] F. Bergeron, G. Labelle, and P. Leroux. *Combinatorial species and tree-like structures*, volume 67 of *Encyclopedia of Mathematics and*

- its Applications*. Cambridge University Press, Cambridge, 1998. Translated from the 1994 French original by Margaret Readdy, With a foreword by Gian-Carlo Rota.
- [38] F. R. Bernhart. Catalan, Motzkin, and Riordan numbers. *Discrete Math.*, 204(1-3):73–112, 1999.
- [39] J. Bertrand. Solution d'un probleme. *Comptes Rendus de l'Académie des Sciences*, 105:369, 1887.
- [40] P. Billingsley. *Probability and measure*. Wiley Series in Probability and Mathematical Statistics: Probability and Mathematical Statistics. John Wiley & Sons, Inc., New York, second edition, 1986.
- [41] M. T. L. Bizley. Derivation of a new formula for the number of minimal lattice paths from $(0,0)$ to (km, kn) having just t contacts with the line $my = nx$ and having no points above this line; and a proof of Grossman's formula for the number of paths which may touch but do not rise above this line. *J. Inst. Actuar.*, 80:55–62, 1954.
- [42] M. Bodirsky, É. Fusy, M. Kang, and S. Vigerske. Boltzmann samplers, Pólya theory, and cycle pointing. *SIAM J. Comput.*, 40(3):721–769, 2011.
- [43] A. Bostan, M. Bousquet-Mélou, M. Kauers, and S. Melczer. On 3-dimensional lattice walks confined to the positive octant. *Annals of Comb.*, 2014.
- [44] M. Bousquet-Mélou. Discrete excursions. *Sém. Lothar. Combin.*, 57:23 pp., 2008.
- [45] M. Bousquet-Mélou, É. Fusy, and L.-F. Prévaille-Ratelle. The number of intervals in the m -Tamari lattices. *Electron. J. Combin.*, 18(2):Paper 31, 26, 2011.
- [46] M. Bousquet-Mélou and A. Jehanne. Polynomial equations with one catalytic variable, algebraic series and map enumeration. *J. Combin. Theory Ser. B*, 96(5):623–672, 2006.
- [47] M. Bousquet-Mélou, M. Lohrey, S. Maneth, and E. Noeth. Xml compression via directed acyclic graphs. *Theory of Computing Systems*, 57(4):1322–1371, 2015.
- [48] M. Bousquet-Mélou and M. Mishna. Walks with small steps in the quarter plane. In *Algorithmic probability and combinatorics*, volume 520 of *Contemp. Math.*, pages 1–39. Amer. Math. Soc., Providence, RI, 2010.

- [49] M. Bousquet-Mélou and M. Mishna. Walks with small steps in the quarter plane. In *Algorithmic probability and combinatorics*, volume 520 of *Contemp. Math.*, pages 1–39. Amer. Math. Soc., Providence, RI, 2010.
- [50] M. Bousquet-Mélou and M. Petkovšek. Linear recurrences with constant coefficients: the multivariate case. *Discrete Math.*, 225(1-3):51–75, 2000. Formal power series and algebraic combinatorics.
- [51] R. Brak, G. K. Iliev, and T. Prellberg. An infinite family of adsorption models and restricted Lukasiewicz paths. *J. Stat. Phys.*, 145(3):669–685, 2011.
- [52] W. G. Brown. On the existence of square roots in certain rings of power series. *Math. Ann.*, 158:82–89, 1965.
- [53] A. Burstein. Restricted Dumont permutations. *Ann. Comb.*, 9(3):269–280, 2005.
- [54] L. Carlitz. The number of binomial coefficients divisible by a fixed power of a prime. *Rend. Circ. Mat. Palermo (2)*, 16:299–320, 1967.
- [55] E. Cateland. *Digital sequences and k-regular sequences*. Thesis, Université Sciences et Technologies - Bordeaux I, June 1992.
- [56] D. V. Chudnovsky and G. V. Chudnovsky. On expansion of algebraic functions in power and Puiseux series. I. *J. Complexity*, 2(4):271–294, 1986.
- [57] F. Chung, R. Graham, J. Morrison, and A. Odlyzko. Pebbling a chessboard. *Amer. Math. Monthly*, 102(2):113–123, 1995.
- [58] K. S. Davis and W. A. Webb. Lucas’ theorem for prime powers. *European J. Combin.*, 11(3):229–233, 1990.
- [59] D. Denisov and V. Wachtel. Random walks in cones. *Ann. Probab.*, 43(3):992–1044, 2015.
- [60] L. E. Dickson. *History of the theory of numbers. Vol. I: Divisibility and primality*. Carnegie Institution of Washington, 1919. Chapter IX: “Divisibility of factorials and multinomial coefficients”.
- [61] NIST Digital Library of Mathematical Functions. <http://dlmf.nist.gov/>, Release 1.0.13 of 2016-09-16. F. W. J. Olver, A. B. Olde Daalhuis, D. W. Lozier, B. I. Schneider, R. F. Boisvert, C. W. Clark, B. R. Miller and B. V. Saunders, eds.
- [62] C. Döbler. Stein’s method for the half-normal distribution with applications to limit theorems related to the simple symmetric random walk. *ALEA*, 12(1):171–191, 2015.

- [63] R. Donaghey and L. W. Shapiro. Motzkin numbers. *J. Combinatorial Theory Ser. A*, 23(3):291–301, 1977.
- [64] M. Drmota. Asymptotic distributions and a multivariate Darboux method in enumeration problems. *J. Combin. Theory Ser. A*, 67(2):169–184, 1994.
- [65] M. Drmota. The height distribution of leaves in rooted trees. *Discrete Mathematics and Applications*, 4(1):45–58, 1994.
- [66] M. Drmota. *Random trees: an interplay between combinatorics and probability*. Springer Science & Business Media, 2009.
- [67] M. Drmota and B. Gittenberger. The shape of unlabeled rooted random trees. *European J. Combin.*, 31(8):2028–2063, 2010.
- [68] M. Drmota, M. Kauers, and L. Spiegelhofer. On a Conjecture of Cusick Concerning the Sum of Digits of n and $n + t$. *SIAM J. Discrete Math.*, 30(2):621–649, 2016. arXiv:1509.08623.
- [69] M. Drmota and M. Soria. Marking in combinatorial constructions: Generating functions and limiting distributions. *Theoretical Comput. Sci.*, 144(1–2):67–99, 1995.
- [70] M. Drmota and M. Soria. Images and preimages in random mappings. *SIAM Journal on Discrete Mathematics*, 10(2):246–269, 1997.
- [71] E. Duchi. On some classes of prudent walks. *Proceedings of FPSAC'2005, Taormina (Italy)*, 2015.
- [72] E. Duchi, J.-M. Fédou, and S. Rinaldi. From object grammars to ECO systems. *Theoret. Comput. Sci.*, 314(1-2):57–95, 2004.
- [73] P. Duchon. On the enumeration and generation of generalized Dyck words. *Discrete Math.*, 225(1-3):121–135, 2000. Formal power series and algebraic combinatorics (Toronto, 1998).
- [74] P. Duchon, P. Flajolet, G. Louchard, and G. Schaeffer. Boltzmann samplers for the random generation of combinatorial structures. *Combin. Probab. Comput.*, 13(4-5):577–625, 2004.
- [75] H. Duminil-Copin and S. Smirnov. The connective constant of the honeycomb lattice equals $\sqrt{2 + \sqrt{2}}$. *Ann. of Math. (2)*, 175(3):1653–1665, 2012.
- [76] A. Dvoretzky and T. Motzkin. The asymptotic density of certain sets of real numbers. *Duke Math. J.*, 14:315–321, 1947.
- [77] B. Eynard. *Counting surfaces*, volume 70 of *Progress in Mathematical Physics*. Birkhäuser/Springer, [Cham], 2016. CRM Aisenstadt chair lectures.

- [78] G. Fayolle, R. Iasnogorodski, and V. Malyshev. *Random walks in the quarter-plane*, volume 40 of *Applications of Mathematics*. Springer-Verlag, 1999.
- [79] W. Feller. Diffusion processes in one dimension. *Trans. Amer. Math. Soc.*, 77:1–31, 1954.
- [80] W. Feller. *An introduction to probability theory and its applications. Vol. I*. Third edition. John Wiley & Sons, 1968.
- [81] L. Ferrari, E. Pergola, R. Pinzani, and S. Rinaldi. Some applications arising from the interactions between the theory of Catalan-like numbers and the ECO method. *Ars Combin.*, 99:109–128, 2011.
- [82] N. J. Fine. Binomial coefficients modulo a prime. *Amer. Math. Monthly*, 54:589–592, 1947.
- [83] P. Flajolet. Combinatorial aspects of continued fractions. *Discrete Math.*, 32(2):125–161, 1980.
- [84] P. Flajolet, P. Grabner, P. Kirschenhofer, H. Prodinger, and R. F. Tichy. Mellin transforms and asymptotics: digital sums. *Theoret. Comput. Sci.*, 123(2):291–314, 1994.
- [85] P. Flajolet and R. Sedgewick. *Analytic Combinatorics*. Cambridge University Press, 2009.
- [86] P. Flajolet, P. Sipala, and J.-M. Steyaert. Analytic variations on the common subexpression problem. In *Automata, languages and programming (Coventry, 1990)*, volume 443 of *Lecture Notes in Comput. Sci.*, pages 220–234. Springer, New York, 1990.
- [87] P. Flajolet, P. Zimmerman, and B. Van Cutsem. A calculus for the random generation of labelled combinatorial structures. *Theoret. Comput. Sci.*, 132(1-2):1–35, 1994.
- [88] P. J. Flory. *Principles of Polymer Chemistry*. Cornell University Press, London, 1953.
- [89] R. D. Fray. Congruence properties of ordinary and q -binomial coefficients. *Duke Math. J.*, 34:467–480, 1967.
- [90] M. Fréchet and J. Shohat. A proof of the generalized second-limit theorem in the theory of probability. *Transactions of the American Mathematical Society*, 33(2):pp. 533–543, 1931.
- [91] S. Friedberg, A. Insel, and L. Spence. *Linear Algebra*. Featured Titles for Linear Algebra (Advanced) Series. Pearson Education, 2003.

- [92] G. S. a. G. Pólya. *Aufgaben und Lehrsätze aus der Analysis: Erster Band: Reihen · Integralrechnung Funktionentheorie*. Die Grundlehren der Mathematischen Wissenschaften 20. Springer-Verlag Berlin Heidelberg, 1 edition, 1925.
- [93] V. Garbaliuskienė, J. Genys, and R. Ivanauskaitė. A limit theorem for the arguments of zeta-functions of certain cusp forms. *Acta Appl. Math.*, 96(1-3):221–231, 2007.
- [94] M. Gaudin. *The Bethe wavefunction*. Cambridge University Press, New York, 2014. Translated from the 1983 French original, published by Masson.
- [95] I. M. Gessel. A factorization for formal laurent series and lattice path enumeration. *Journal of Combinatorial Theory, Series A*, 28(3):321–337, 1980.
- [96] B. Gittenberger, A. Genitrini, M. Kauers, and M. Wallner. Compact binary trees. *Manuscript*, 2017. In preparation.
- [97] B. Gittenberger, E. Y. Jin, and M. Wallner. A note on the scaling limits of random polya trees. In *2017 Proceedings of the Fourteenth Workshop on Analytic Algorithmics and Combinatorics (ANALCO)*. 2017. To appear.
- [98] J. Glaisher. On the residue of a binomial-theorem coefficient with respect to a prime modulus. *Quarterly Journal of Pure and Applied Mathematics*, 30:150–156, 1899.
- [99] M. Goldwurm. Random generation of words in an algebraic language in linear binary space. *Inform. Process. Lett.*, 54(4):229–233, 1995.
- [100] X. Gourdon. Largest component in random combinatorial structures. In *Proceedings of the 7th Conference on Formal Power Series and Algebraic Combinatorics (Noisy-le-Grand, 1995)*, volume 180, pages 185–209, 1998.
- [101] A. Granville. Zaphod Beeblebrox’s brain and the fifty-ninth row of Pascal’s triangle. *Amer. Math. Monthly*, 99(4):318–331, 1992.
- [102] A. Granville. *Arithmetic properties of binomial coefficients. I. Binomial coefficients modulo prime powers*, volume 20 of *CMS Conf. Proc.* Amer. Math. Soc., Providence, RI, 1997.
- [103] G. H. Hardy and S. Ramanujan. Asymptotic formulæ for the distribution of integers of various types [Proc. London Math. Soc. (2) **16** (1917), 112–132]. In *Collected papers of Srinivasa Ramanujan*, pages 245–261. AMS Chelsea Publ., Providence, RI, 2000.

- [104] P. Henrici. *Applied and computational complex analysis. Vol. 2.* Wiley Classics Library. John Wiley & Sons, Inc., New York, 1991. Special functions—integral transforms—asymptotics—continued fractions, Reprint of the 1977 original, A Wiley-Interscience Publication.
- [105] T. Hickey and J. Cohen. Uniform random generation of strings in a context-free language. *SIAM J. Comput.*, 12(4):645–655, 1983.
- [106] F. T. Howard. A combinatorial problem and congruences for the Rayleigh function. *Proc. Amer. Math. Soc.*, 26:574–578, 1970.
- [107] F. T. Howard. The number of binomial coefficients divisible by a fixed power of 2. *Proc. Amer. Math. Soc.*, 29:236–242, 1971.
- [108] F. T. Howard. Formulas for the number of binomial coefficients divisible by a fixed power of a prime. *Proc. Amer. Math. Soc.*, 37:358–362, 1973.
- [109] J. G. Huard, B. K. Spearman, and K. S. Williams. On Pascal's triangle modulo p^2 . *Colloq. Math.*, 74(1):157–165, 1997.
- [110] B. D. Hughes. *Random walks and random environments. Vol. 1.* Oxford Science Publications. The Clarendon Press Oxford University Press, New York, 1995. Random walks.
- [111] K. Humphreys. A history and a survey of lattice path enumeration. *J. Statist. Plann. Inference*, 140(8):2237–2254, 2010.
- [112] B. Hunter, A. C. Krinik, C. Nguyen, J. M. Switkes, and H. F. Von Bremen. Gambler's Ruin with Catastrophes and Windfalls. *Journal of Statistical Theory and Practice*, 2008.
- [113] H.-K. Hwang. On convergence rates in the central limit theorems for combinatorial structures. *European J. Combin.*, 19(3):329–343, 1998.
- [114] E. L. Ince. *Ordinary Differential Equations.* Dover Publications, New York, 1944.
- [115] J. L. Jain, S. G. Mohanty, and W. Böhm. *A course on queueing models.* Statistics: Textbooks and Monographs. Chapman & Hall/CRC, Boca Raton, FL, 2007.
- [116] E. J. Janse van Rensburg. Square lattice directed paths adsorbing on the line $y = qx$. *Journal of Statistical Mechanics: Theory and Experiment*, 2005(09):P09010, 2005.
- [117] E. J. Janse van Rensburg, T. Prellberg, and A. Rechnitzer. Partially directed paths in a wedge. *J. Combin. Theory Ser. A*, 115(4):623–650, 2008.

- [118] E. J. Janse van Rensburg and A. Rechnitzer. Adsorbing and collapsing directed animals. *J. Statist. Phys.*, 105(1-2):49–91, 2001.
- [119] S. Janson. Brownian excursion area, Wright’s constants in graph enumeration, and other Brownian areas. *Probab. Surv.*, 4:80–145, 2007.
- [120] S. Janson. Simply generated trees, conditioned Galton-Watson trees, random allocations and condensation. *Probab. Surv.*, 9:103–252, 2012.
- [121] S. Johnson. Analytic combinatorics of planar lattice paths. Master’s thesis, Simon Fraser University, 2012.
- [122] M. Kauers and P. Paule. *The concrete tetrahedron*. Texts and Monographs in Symbolic Computation. Springer, 2011. Symbolic sums, recurrence equations, generating functions, asymptotic estimates.
- [123] G. S. Kazandzidis. Congruences on the binomial coefficients. *Bull. Soc. Math. Grèce (N.S.)*, 9(fasc. 1):1–12, 1968.
- [124] A. J. Kempner. A theorem on lattice-points. *Annals of Mathematics*, 19(2):127–136, 1917.
- [125] J. F. C. Kingman. On queues in heavy traffic. *J. Roy. Statist. Soc. Ser. B*, 24:383–392, 1962.
- [126] D. E. Knuth. *The art of computer programming. Vol. 1: Fundamental algorithms*. Addison-Wesley, 1968.
- [127] D. E. Knuth. *20th Annual Christmas Tree Lecture: (3/2)-ary Trees*. Stanford University, 2014. <https://www.youtube.com/watch?v=P4AaGQIo0HY>.
- [128] D. E. Knuth and H. S. Wilf. The power of a prime that divides a generalized binomial coefficient. *J. Reine Angew. Math.*, 396:212–219, 1989.
- [129] C. Krattenthaler. *Lattice Path Enumeration*. CRC Press, 2015. in: Handbook of Enumerative Combinatorics, M. Bóna (ed.), Discrete Math. and Its Appl.
- [130] V. Kraus. *Asymptotic study of families of unlabelled trees and other unlabelled graph structures*. Thesis, TU Wien, 2011.
- [131] A. Krinik, G. Rubino, D. Marcus, R. J. Swift, H. Kasfy, and H. Lam. Dual processes to solve single server systems. *J. Statist. Plann. Infer.*, 135(1):121–147, 2005.
- [132] E. E. Kummer. Über die Ergänzungssätze zu den allgemeinen Reciprocitätsgesetzen. *J. Reine Angew. Math.*, 44:93–146, 1852.

- [133] I. Kurkova and K. Raschel. On the functions counting walks with small steps in the quarter plane. *Publ. Math. Inst. Hautes Études Sci.*, 116:69–114, 2012.
- [134] J. Labelle and Y.-N. Yeh. Generalized Dyck paths. *Discrete Math.*, 82(1):1–6, 1990.
- [135] J.-L. Lagrange. Nouvelle méthode pour résoudre les équations littérales par le moyen des séries. *Mémoires de l'Académie Royale des Sciences et Belles-Lettres de Berlin*, 24:251–326, 1770. Reprinted in *Œuvres de Lagrange*, tome 2. Paris: Gauthier-Villars, pp. 655–726, 1868.
- [136] T. M. Liggett. Ultra logconcave sequences and negative dependence. *Journal of Combinatorial Theory, Series A*, 79(2):315–325, 1997.
- [137] V. A. Liskovets. Exact enumeration of acyclic deterministic automata. *Discrete Applied Mathematics*, 154(3):537–551, 2006.
- [138] L. L. Liu and Y. Wang. A unified approach to polynomial sequences with only real zeros. *Adv. in Appl. Math.*, 38(4):542–560, 2007.
- [139] E. Lucas. Sur les congruences des nombres eulériens et les coefficients différentiels des fonctions trigonométriques suivant un module premier. *Bull. Soc. Math. France*, 6:49–54, 1878.
- [140] T. Mansour and M. Shattuck. Pattern avoiding partitions, sequence A054391 and the kernel method. *Appl. Appl. Math.*, 6(12):397–411, 2011.
- [141] A. Meir and J. W. Moon. On the altitude of nodes in random trees. *Canad. J. Math.*, 30(5):997–1015, 1978.
- [142] D. Merlini, R. Sprugnoli, and M. C. Verri. The area determined by underdiagonal lattice paths. *Proceedings of CAAP'96, Lecture Notes in Computer Science 1059*, pages 59–71, 1996.
- [143] R. Miranda. *Algebraic curves and Riemann surfaces*, volume 5. Amer Mathematical Society, 1995.
- [144] D. Mirimanoff. À propos de l'interprétation géométrique du problème du scrutin. *Enseign. Math.*, 23:187–189, 1923.
- [145] S. G. Mohanty. *Lattice path counting and applications*. Academic Press [Harcourt Brace Jovanovich, Publishers], 1979. Probability and Mathematical Statistics.
- [146] T. Motzkin. Relations between hypersurface cross ratios, and a combinatorial formula for partitions of a polygon, for permanent preponderance, and for non-associative products. *Bull. Amer. Math. Soc.*, 54:352–360, 1948.

- [147] T. Nakamigawa and N. Tokushige. Counting lattice paths via a new cycle lemma. *SIAM J. Discrete Math.*, 26(2):745–754, 2012.
- [148] T. V. Narayana. *Lattice path combinatorics with statistical applications*, volume 23 of *Mathematical Expositions*. University of Toronto Press, 1979.
- [149] A. Nijenhuis and H. S. Wilf. *Combinatorial algorithms*. Academic Press, Inc. [Harcourt Brace Jovanovich, Publishers], New York-London, second edition, 1978. For computers and calculators, Computer Science and Applied Mathematics.
- [150] R. Otter. The number of trees. *Ann. of Math. (2)*, 49:583–599, 1948.
- [151] K. Panagiotou and B. Stufler. Scaling limits of random pólya trees. *arXiv preprint*, arXiv:1502.07180, 2015. <https://arxiv.org/abs/1502.07180>.
- [152] R. Pemantle. Towards a theory of negative dependence. *Journal of Mathematical Physics*, 41(3):1371–1390, 2000.
- [153] R. Pemantle and M. C. Wilson. *Analytic combinatorics in several variables*, volume 140 of *Cambridge Studies in Advanced Mathematics*. Cambridge University Press, Cambridge, 2013.
- [154] O. Perron. Über das infinitäre Verhalten der Koeffizienten einer gewissen Potenzreihe. *Arch. der Math. u. Phys. (3)*, 22:329–340, 1914.
- [155] M. Petkovšek. The irrational chess knight. *Proceedings of FPSAC'98*, pages 513–522, 1998. Formal power series and algebraic combinatorics (Toronto, July 1998).
- [156] M. Petkovsek, H. S. Wilf, and D. Zeilberger. *A = B*. AK Peters, 1996.
- [157] G. Pólya. Kombinatorische anzahlbestimmungen für gruppen, graphen und chemische verbindungen. *Acta Mathematica*, 68(1):145–254, 1937.
- [158] H. Prodinger. The kernel method: a collection of examples. *Sém. Lothar. Combin.*, 50:Art. B5of, 19, 2003/04.
- [159] R. W. Robinson. Counting labeled acyclic digraphs. In *New directions in the theory of graphs (Proc. Third Ann Arbor Conf., Univ. Michigan, Ann Arbor, Mich., 1971)*, pages 239–273. Academic Press, New York, 1973.
- [160] E. Rowland. The number of nonzero binomial coefficients modulo p^a . *J. Comb. Number Theory*, 3(1):15–25, 2011.

- [161] B. Salvy and P. Zimmermann. Gfun: a Maple package for the manipulation of generating and holonomic functions in one variable. *ACM Transactions on Mathematical Software*, 20(2):163–177, 1994.
- [162] M. Sato. Generating functions for the number of lattice paths between two parallel lines with a rational incline. *Math. Japon.*, 34(1):123–137, 1989.
- [163] L. Schlesinger. *Handbuch der Theorie der linearen Differentialgleichungen. In zwei Bänden, Band I*. Reprint. Bibliotheca Mathematica Teubneriana, Band 30. Johnson Reprint Corp., New York-London, 1968.
- [164] E. Schulte-Geers and W. Stadje. Maximal percentages in Pólya’s urn. *J. Appl. Probab.*, 52(1):180–190, 2015.
- [165] U. Schwerdtfeger. Linear functional equations with a catalytic variable and area limit laws for lattice paths and polygons. *European J. Combin.*, 36:608–640, 2014.
- [166] D. Singmaster. Notes on binomial coefficients. I. A generalization of Lucas’ congruence. *J. London Math. Soc. (2)*, 8:545–548, 1974.
- [167] D. Singmaster. Notes on binomial coefficients. III. Any integer divides almost all binomial coefficients. *J. London Math. Soc. (2)*, 8:555–560, 1974.
- [168] D. Singmaster. *Divisibility of binomial and multinomial coefficients by primes and prime powers*. Fibonacci Assoc., Santa Clara, Calif., 1980.
- [169] J. G. Skellam and L. R. Shenton. Distributions associated with random walk and recurrent events. *J. Roy. Statist. Soc. Ser. B.*, 19:64–111 (discussion 111–118), 1957.
- [170] A. V. Skorokhod. Stochastic equations for diffusion processes with boundaries. II. *Teor. Veroyatnost. i Primenen.*, 7:5–25, 1962.
- [171] B. K. Spearman and K. S. Williams. On a formula of Howard. *Bull. Hong Kong Math. Soc.*, 2(2):325–340, 1999. (Available on Spearman’s website).
- [172] L. Spiegelhofer and M. Wallner. Divisibility of binomial coefficients by powers of primes. *arXiv preprint*, arXiv:1604.07089, 2016. <http://arxiv.org/abs/1604.07089>. Submitted.
- [173] R. Stanley. *Catalan Numbers*. Cambridge University Press, 2015.

- [174] R. P. Stanley. *Enumerative combinatorics. Vol. 2*, volume 62 of *Cambridge Studies in Advanced Mathematics*. Cambridge University Press, Cambridge, 1999.
- [175] R. P. Stanley. *Enumerative combinatorics. Volume 1*, volume 49 of *Cambridge Studies in Advanced Mathematics*. Cambridge University Press, Cambridge, second edition, 2011.
- [176] K. B. Stolarsky. Power and exponential sums of digital sums related to binomial coefficient parity. *SIAM J. Appl. Math.*, 32(4):717–730, 1977.
- [177] B. Stufler. Random enriched trees with applications to random graphs. *arXiv preprint*, arXiv:1504.02006, 2015. <https://arxiv.org/abs/1504.02006>.
- [178] M. Tsagris, C. Beneki, and H. Hassani. On the folded normal distribution. *Mathematics*, 2(1):12, 2014.
- [179] C. Walck. *Hand-book on statistical distributions for experimentalists*. Dec. 1996. <http://www.fysik.su.se/~walck/suf9601.pdf>. Online; accessed 22/10/2014.
- [180] M. Wallner. Lattice path combinatorics. Master’s thesis, Vienna University of Technology, 2013.
- [181] M. Wallner. A half-normal distribution scheme for generating functions. *arXiv preprint*, arXiv:1610.00541, 2016. <http://arxiv.org/abs/1610.00541>. Submitted.
- [182] M. Wallner. A half-normal distribution scheme for generating functions and the unexpected behavior of motzkin paths. In *Proceedings of the 27th International Conference on Probabilistic, Combinatorial and Asymptotic Methods for the Analysis of Algorithms*, pages 341–352, 2016.
- [183] Y. Wang and Y.-N. Yeh. Log-concavity and lc-positivity. *Journal of Combinatorial Theory, Series A*, 114(2):195 – 210, 2007.
- [184] W. Wasow. *Asymptotic expansions for ordinary differential equations*. Dover Publications, Inc., New York, 1987. Reprint of the 1976 edition.
- [185] W. A. Webb. The number of binomial coefficients in residue classes modulo p and p^2 . *Colloq. Math.*, 60/61(1):275–280, 1990.
- [186] J. West. Generating trees and forbidden subsequences. *Discrete Mathematics*, 157:363–374, 1996.
- [187] H. S. Wilf. *generatingfunctionology*. Academic Press Inc., Boston, MA, second edition, 1994.

- [188] E. M. Wright. The Coefficients of a Certain Power Series. *J. London Math. Soc.*, S1-7(4):256, 1933.

CURRICULUM VITÆ – MICHAEL WALLNER

PERSONAL INFORMATION

Address Siccardsburggasse 40/120, 1100 Vienna, Austria
Email michael.wallner@tuwien.ac.at
Web <http://dmg.tuwien.ac.at/mwallner/>
Born December 3rd, 1987 in Oberwart
Citizenship Austrian

EDUCATION

Nov 2013 – **PHD studies**, *Technische Universität Wien (TU Wien)*,
Jan 2017 under the supervision of Bernhard Gittenberger
Jul 2011 – **MSc studies of “Technische Mathematik in den
Oct 2013 Computerwissenschaften”**, *Technische Universität
Wien (TU Wien)*
Oct 2013 **Master’s degree (Dipl.-Ing.)**, *Technische Universität
Wien (TU Wien)*, Master’s thesis “Lattice path combi-
natorics” supervised by Michael Drmota, passed with
distinction
Sep 2011 – **MSc studies of “Computational Mathematics with
Sep 2012 Modelling”**, *Brunel University London*
Oct 2013 **Master’s degree**, *Brunel University London*, Master’s
thesis “Algebraic Multigrid Methods for Higher-
Order Finite Element Discretization with paralleliza-
tion” supervised by Matthias Maischak, passed with
distinction
Oct 2008 – **BSc studies of “Technische Mathematik in den Com-
Jul 2011 puterwissenschaften”**, *Technische Universität Wien (TU
Wien)*
Jul 2011 **Bachelor’s degree**, *Technische Universität Wien (TU
Wien)*, Bachelor’s thesis “Factorization of polynomi-
als over finite fields” supervised by Michael Drmota,
passed with distinction
Sep 2002 – **HTBL Pinkafeld**, Abteilung für EDV&O
Jun 2007
Jun 2007 **Austrian Matura**, *HTBL Pinkafeld*, passed with distinc-
tion

ACADEMIC CAREER

All positions so far at the Institute for Discrete Mathematics and Geometry at the Vienna University of Technology.

- Nov 2013 – **Research fellow**, FWF-project SFB F50-03 “*Algorithmic and Enumerative Combinatorics*”, Project “*Combinatorics of Tree-Like Structures and Enriched Trees*”, Project director: Prof. Bernhard Gittenberger
- Dez 2013 – **Graduate teaching and research assistant**, Under the responsibility of Prof. Michael Drmota and Prof. Monika Ludwig
- Feb 2016
- Mar 2012 – **Tutor**, *Exercises of numerical mathematics for mathematics students*, Under the responsibility of Prof. Ewa Weinmüller
- Jun 2012

RESEARCH AREAS TO DATE

- Combinatorics: Enumeration of labeled and unlabeled combinatorial objects - exact and asymptotic results; generating functions and limit laws
- Lattice paths: enumeration and asymptotic results; applications of the kernel method
- Number theory: divisibility by prime numbers; applications of generating functions

SCIENTIFIC ARTICLES

- 2016 *A half-normal distribution scheme for generating functions and the unexpected behavior of Motzkin paths*, in Proceedings of the 27th International Conference on Probabilistic, Combinatorial and Asymptotic Methods for the Analysis of Algorithms, Krakow, pages 341-352.
- 2016 *A half-normal distribution scheme for generating functions*, submitted to a journal.
- 2016 *The kernel method for lattice paths below a line of rational slope*, with Cyril Banderier, accepted for publication in Lattice paths combinatorics and applications, Developments in Mathematics Series, Springer.

- 2016 *Compacted binary trees*, with Bernhard Gittenberger, Antoine Genitrini and Manuel Kauers, work in progress.
- 2016 *Divisibility of binomial coefficients by powers of primes*, with Lukas Spiegelhofer, submitted to a journal.
- 2016 *Explicit formulas for enumeration of lattice paths: basketball and the kernel method*, with Cyril Banderier, Christian Krattenthaler, Alan Krinik, Dmitry Kruchinin, Vladimir Kruchinin and David Nguyen, submitted to a journal.
- 2016 *Lattice paths with catastrophes*, with Cyril Banderier, in Proceedings of the 10th edition of Génération Aléatoire de Structures COMbinatoires (GASCom 2016), La Marana.
- 2016 *Lattice paths with catastrophes*, with Cyril Banderier, work in progress.
- 2016 *A note on the scaling limits of random Pólya trees*, with Bernhard Gittenberger and Emma Yu Jin, accepted for publication in Proceedings of the Fourteenth Workshop on Analytic Algorithmics and Combinatorics (ANALCO17), Barcelona.
- 2016 *The reflection-absorption model for directed lattice paths*, with Cyril Banderier, in Proceedings of the Vienna Young Scientists Symposium (VSS), Vienna, pages 98-99.
- 2015 *Lattice paths of slope $2/5$* , with Cyril Banderier, in Proceedings of the Twelfth Workshop on Analytic Algorithmics and Combinatorics (ANALCO15), San Diego, pages 105-113.
- 2014 *Some reflections on directed lattice paths*, with Cyril Banderier, in Proceedings of the 25th International Conference on Probabilistic, Combinatorial and Asymptotic Methods for the Analysis of Algorithms (AofA 2014), Paris, pages 25-36.

TALKS

- 2016 *Compacted binary trees*
SFB F50 Algorithmic and Enumerative Combinatorics status seminar, Strobl, Austria.
- 2016 *A note on the scaling limits of random Pólya trees*
Seminar of the “Arbeitsgemeinschaft Diskrete Mathematik”, TU Wien, Austria.
- 2016 *Lattice paths with catastrophes*
77th Séminaire Lotharingien de combinatoire (SLC77), Strobl, Austria.
- 2016 *A half-normal distribution scheme for generating functions*
Asymptotic Analysis of Algorithms & Combinatorial Structures (A3CS), Paris, France.
- 2016 *A half-normal distribution scheme for generating functions and the unexpected behavior of Motzkin paths*
27th International Conference on Probabilistic, Combinatorial and Asymptotic Methods for the Analysis of Algorithms (AofA 2016), Kraków, Poland.
- 2016 *Lattice paths below a line of rational slope*
Final conférence of the MADACA project, Domaine de Chalès, France.
- 2016 *A half-normal distribution scheme for generating functions*
Seminar of the “Arbeitsgemeinschaft Diskrete Mathematik”, TU Wien, Austria.
- 2016 *The reflection-absorption model for directed lattice paths*
VIENNA young SCIENTISTS SYMPOSIUM (VSS16), Vienna, Austria.
- 2015 *An Invitation to Analytic Combinatorics and Lattice Path Counting*
ALEA in Europe Young Researchers’ Workshop, University of Bath, Bath, UK.
- 2015 *Counting compacted trees*
SFB F50 Algorithmic and Enumerative Combinatorics status seminar, Strobl, Austria.
- 2015 *Why and when does the half-normal distribution appear in combinatorics?*
Séminaire de combinatoire, LIPN, Paris, France.

- 2015 *A half-normal limit distribution scheme and applications to lattice paths*
8th International Conference on Lattice Path Combinatorics & Applications, Cal Poly Pomona, USA.
- 2015 *The extension of a Rayleigh limiting distribution scheme*
SFB workshop on Lattice Walks, Hagenberg, Austria.
- 2015 *Lattice paths of slope 2/5*
Twelfth Workshop on Analytic Algorithmics and Combinatorics (ANALCO15), San Diego, USA.
- 2014 *Lattice paths of slope 2/5*
SFB F50 Algorithmic and Enumerative Combinatorics status seminar, Strobl, Austria.
- 2014 *Lattice paths of slope 2/5 – Solving a problem of Knuth*
Seminar of the “Arbeitsgemeinschaft Diskrete Mathematik”, TU Wien, Austria.
- 2014 *Some (more) reflections on lattice paths*
Probability seminar of the Université Francois Rabalais, Tours, France.
- 2014 *Some reflections on lattice paths*
25th International Conference on Probabilistic, Combinatorial and Asymptotic Methods for the Analysis of Algorithms (AofA 2014), Paris, France.
- 2014 *Some reflections on directed lattice paths*
Seminar of the “Arbeitsgemeinschaft Diskrete Mathematik”, TU Wien, Austria.

COLOPHON

This document was typeset using the typographical look-and-feel classicthesis developed by André Miede. The style was inspired by Robert Bringhurst's seminal book on typography "*The Elements of Typographic Style*". classicthesis is available for both L^AT_EX and L^yX:

<http://code.google.com/p/classicthesis/>

Happy users of classicthesis usually send a real postcard to the author, a collection of postcards received so far is featured here:

<http://postcards.miede.de/>