

# AUTOMATIC TRACK GAUGE CHANGEOVER FOR TRAINS IN SPAIN

Alberto García Álvarez



FUNDACIÓN DE LOS  
FERROCARRILES  
ESPAÑOLES

[www.ffe.es](http://www.ffe.es)

DOCUMENTOS DE  
EXPLOTACIÓN ECONÓMICA  
Y TÉCNICA DEL FERROCARRIL

September 2010





# Automatic track gauge changeover for trains in Spain

Alberto García Álvarez

4° edition. August 2010

## **Automatic track gauge changeover for trains in Spain**

**Alberto García Álvarez**

Monograph based on the articles: “*Cambiadores de ancho, trenes de ancho variable y tercer carril: Nuevas soluciones a un viejo problema*”, Journal: *Anales de Mecánica y Electricidad*, January-February 2007; “*Los de Roda y Antequera incorporan todas las novedades: Los cambiadores de ancho, nueva solución a un viejo problema*”, *Vía Libre*, January 2007; and “*Cambiadores de la línea de Madrid a Valladolid*”, *Vía Libre*, December 2007. Adapted, expanded and updated by the author in 2009.

Keywords: Railway, interoperability, gauge changeover, high speed

Ed.: *Vía Libre*

© Author: Alberto García Álvarez

© 4<sup>o</sup> edition, august 2010, Fundación de los Ferrocarriles Españoles

Translated by “Servicio de Traducciones de la Fundación de los Ferrocarriles Españoles”

Maps and illustrations Miguel Jimenez Vega and Luis Eduardo Mesa Santos

ISBN: 978-84-89649-56-9

Dto. Legal: M-27127-2009

# Contents

<b>CONTENTS.....</b>	<b>5</b>
<b>INTRODUCTION.....</b>	<b>7</b>
Different track gauges: the problem and the solutions .....	7
Definition of “track gauge” .....	16
Track gauges throughout the world .....	18
Track gauges in Spain .....	20
Origin of the standard track gauge .....	21
The peculiarity of the Spanish track gauge .....	23
<b>GAUGE CHANGEOVER SYSTEMS AND INSTALLATIONS .....</b>	<b>28</b>
Historical evolution of automatic gauge changers .....	29
Border changers: first generation.....	33
Changers on the Madrid-Seville high-speed line: second generation .....	39
Madrid-Barcelona high-speed line. The third generation arrives .....	44
<b>CHARACTERISTICS OF THE THIRD-GENERATION CHANGERS .....</b>	<b>52</b>
“Sunken” profile .....	53
Modularity and portability .....	54
Catenary .....	56
De-icing.....	59
Automation and remote control.....	60
Dual changers .....	61
Technology and systems of the third-generation changerst.....	62
<b>AUTOMATIC GAUGE CHANGERS IN SPAIN .....</b>	<b>67</b>
List of changers installed in Spain .....	68
Gauge changeover operations performed in the changers.....	71
<b>VARIABLE GAUGE TRAINS AND SERVICES .....</b>	<b>76</b>
Variable gauge Talgo trailers .....	77
The Talgo XXI train .....	83
The TRDs with CAF “Brava” bogie .....	84
The Talgo-Team locomotive .....	85
Talgo freight wagons for gauge changeover.....	87
The CAF series 120 high-speed train and its offshoots .....	87
The Talgo 250 high-speed train (series 130) .....	89
Passenger services with variable gauge trains .....	91

<b>GAUGE CHANGEOVER R+D+I. OPPORTUNITIES, PROBLEMS AND PROSPECTS.....</b>	<b>95</b>
Dual changers for two technologies (TCRS 1, TCRS 2 y TCRS 3) .....	97
Changer for up to four technologies in the same train (TCRS 4) .....	101
Toward a new generation of gauge changers .....	104
<b>BIBLIOGRAPHY .....</b>	<b>106</b>
<b>ACKNOWLEDGEMENTS .....</b>	<b>106</b>

---

# INTRODUCTION

---

---

## Different track gauges: the problem and the solutions

---

### The problem of the difference in track gauge

---

The characteristic track gauge of the Spanish railway network (1,668 millimetres between inner rail faces) is different from the normal or standard track gauge of most of the European and world rail network (which is 1,435 millimetres).

In principle, trains cannot pass from a line with one track gauge to another with a different gauge, and therefore the existence of “borders” between networks with different track gauges<sup>1</sup> has been a problem for operators and passengers alike, which traditionally has necessitated transfer or changing train, an inconvenient and time-consuming process.

In Spain, the points at which different track gauges coexist are located on the borders with France, but there are also “borders” at Spanish stations, since although the 1,668 mm track gauge predominates, the Spanish rail network also has lines with narrower gauges (1,000 mm and others), giving rise to other “interior borders”.

Moreover, the 1988 decision to build new Spanish high-speed lines to the standard track gauge led to the appearance of new “borders” between the two gauges (and the associated problems) at numerous points of the rail network.

A possible decision to extend the standard track gauge to other “conventional” lines, in order to improve links and freight traffic with the rest of Europe, would shift the current borders with France toward other places, and would probably increase the number of transition points temporarily or definitively, depending on the final scenario adopted.

---

<sup>1</sup> Hereinafter, the term “gauge borders” will be used to refer to the points of the rail network where railway lines with two different track gauges coexist.

## **Types of solutions**

---

To solve this problem, a number of specific solutions have been tested and implemented at different times and in various locations. These solutions can be divided into three different types:

1. Facilitating and simplifying the transfer of passengers and transshipment of goods and the change of locomotive.



For many years, passenger transfer and freight transshipment was the most common solution

2. Using tracks with three or four rails so that trains of either of the two gauges can pass from one network to another and run on both.



Three-rail track that allows the running of trains with two track gauges (in this case, Iberian and standard)



3. Applying systems that allow trains, or any of their vehicles, to change track gauge. Among these systems there are three variants:
  - 3.1. Interchange of wagon or coach axles.



Wagon axle interchanger

- 3.2. Interchange of complete bogies.



Changing bogies in a passenger coach

- 3.3. Automatic track gauge change of a vehicle or of a set of vehicles without changing their axles or wheels, only varying the distance between the latter.



Automatic track gauge changeover without changing axles or bogies

## **Automatic changeover systems**

---

This document deals with the automatic gauge changeover solutions implemented in Spain, without transfer/transshipment or change of wheels. These systems have been used successfully since 1969 and permit an increasing number of services and ever-improving operating conditions.

These automatic systems require the existence of fixed installations through which the trains pass (hereinafter referred to as “gauge changers” or simply “changers”), and in which the distance between the train’s wheels is altered.

Specifically, Spanish automatic gauge changeover systems allow trains to pass automatically from a line with an Iberian track gauge to another with the international track gauge - or vice versa -, and without changing axles or bogies, as the train passes through the installation. Nothing prevents these systems from being able to adapt to other pairs of track gauges, such as, for example, the international standard gauge (1,435 mm) and the “Russian gauge” (1,520 mm).

The Spanish systems operate as follows: as the train passes through the “gauge changer”, the wheels are freed of the weight of the vehicle as it is raised and eventually supported by elevated side rails. Once the wheels no longer withstand the weight of the train, the locks that prevent them from moving sideways during normal running are released, and the wheels are then pushed into their new position along converging or diverging guide rails. Finally, the wheels are locked in place again and the vehicles are lowered onto their wheels. All these operations are performed automatically by means of the fixed guides that the train encounters during its linear passage through the installation.

The train passes through the gauge changer at low speed (up to 15 km/h) without having to stop, except when the locomotive also has to be changed. In this case, the necessary operations for changing the locomotive must be performed in addition to the track gauge change.

The currently existing automatic gauge changeover systems are based on various technologies:

- **Talgo Variable Gauge (“Rodadura Desplazable”) technology.** Having been used uninterruptedly and successfully since 1969, this is the world’s most “experienced” gauge changeover technology. Initially applied to Talgo coaches for passenger trains, it has been available for locomotives and power cars since 1999. There are also variable gauge axles that can be installed in freight wagons and their bogies or in passenger cars.
- **CAF “Brava” technology.** Used since the year 2000 in self-propelled diesel and electric trains, including high-speed trains, it can also be applied to other passenger or freight trains.
- **Polish SUW 2000 technology** is used on the border between Poland and Lithuania, and can be applied to passenger cars or freight wagons.

## *Automatic track gauge changeover for trains in Spain*

*Alberto García Álvarez*

---

- **German DBAG/Rafia “Typ V” technology.** This German technology has no commercial application at present, and has been undergoing tests for several years.
- **Japanese technology** which has been undergoing tests since the mid-1990s.



Class 130 Talgo train (left) and class 120 CAF train (right) starting the automatic track gauge changeover

## The question of the differences between changers

All these technologies are conceptually similar, but they differ in terms of how the train is supported while the gauge is changed, how the gauge change mechanism is released, and how the wheels are secured in the new position.

This means that the changers of each technology are different from and incompatible with each other, which creates two operation problems:

1. The trains of each technology must use a different changer, which would mean having to install as many changers as there are types of train at the *gauge borders*. This poses an operation and cost problem and entails a high level of operational complexity.
2. A (passenger or freight) train that has to cross the gauge border cannot be formed of coaches or wagons of different technologies, since this would force the vehicles of a hypothetical train of these characteristics to be “classified” by technologies before changing gauge.

### Automatic track gauge changeover systems

System	Talgo	CAF	SUW 2000	Rafia	Japan
Country	Spain	Spain	Poland	Germany	Japan
Year of first commercial application	1969	2003	2000	---	(2007)
Passenger coaches	Yes	Yes	Yes	No	Yes
Freight wagons	Yes	No	Yes	Yes	No
Traction vehicles	Yes	Yes	No	No	Yes
Change with load on wheel	No	No	Yes	Yes	No
Block system	Ascending latch	Ascending rolling	Side locking	Side locking	Ascending rolling

## **Versatile changers**

---

To solve the problems caused by the differences between changers of different technologies, “dual” or “versatile” changers have been developed, which can be used by trains of two or more technologies.

Thus, there is a unique “dual” changer for the Polish and German technologies, which are very similar to each other; and in Spain, where the Talgo and CAF technologies have coexisted for years, a research and development process has led to a unification of changers:

- The first stage of this process involved designing, patenting and constructing a “dual changer” which, by means of a fold-away platform, allowed the two trains to pass through (tests at Río Adaja (Valladolid) starting in 2000, and in service at Plasencia de Jalón (Zaragoza) since 2003). This changer is called TCRS1.
- The system was immediately improved by introducing horizontal movement of platforms, which entails simpler and more reliable movement and lower installation costs. This changer, patented by Adif, was used for the first time at Valdestillas (Valladolid) and Madrid Chamartín (December 2007).
- The next step involved developing the design of a changer which, with only the movement of certain parts (as opposed to the movement of platforms), allows both types of train to pass through and also incorporates other improvements (TCRS3, patented by Adif in February 2008). The prototype of this changer has been installed for tests at Roda de Bará, Tarragona (2010).
- Given the need to make gauge changers more versatile, and in anticipation of international freight trains being able to include (in the same train) wagons of different technologies, a “universal changer” was patented by Adif (2008), suitable for Talgo, Caf, Rafia and SUW 2000 technologies. Besides admitting vehicles with all the systems, this changer also allows wagons of different technologies to form part of the same train.

The characteristics of each one of these changers are described in the chapter devoted to R+D+i in the field of automatic gauge changers.

*Automatic track gauge changeover for trains in Spain*

*Alberto García Álvarez*

---

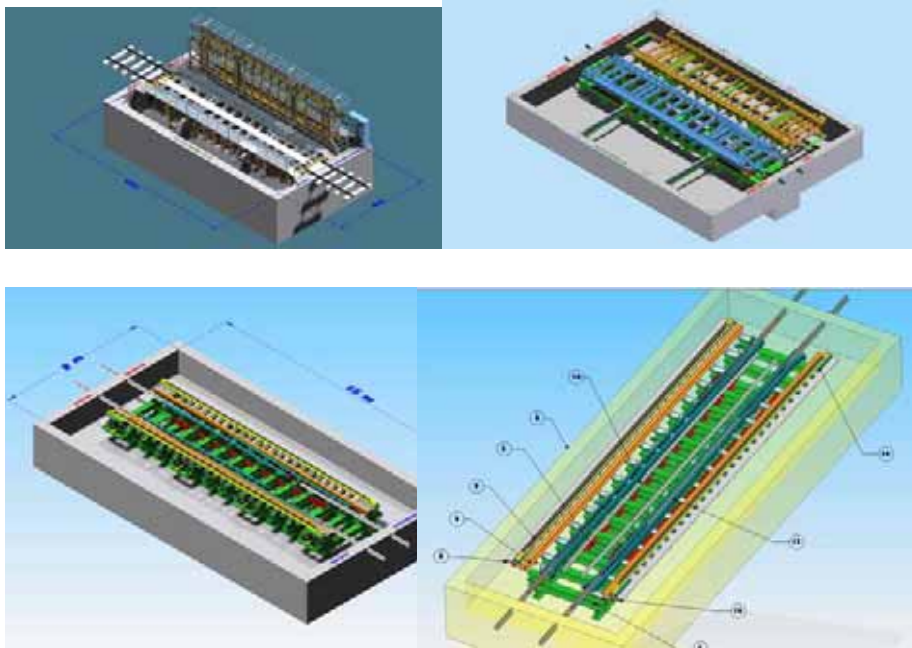

Diagrams of various versatile changers: Top left: TCRS1 Talgo dual fold-away; top right: TCRS2 Talgo CAF horizontal; bottom left: TCRS3 Talgo CAF single platform; bottom right: TCRS4 universal

## Definition of “track gauge”

The “track gauge” is the nominal distance between the inner faces of the rails, measured in millimetres. Specifically, it is the distance between the two active faces of the rail heads, measured at a height of 14.5 mm ( $\pm 0.5$  mm) below the running surface of the track.

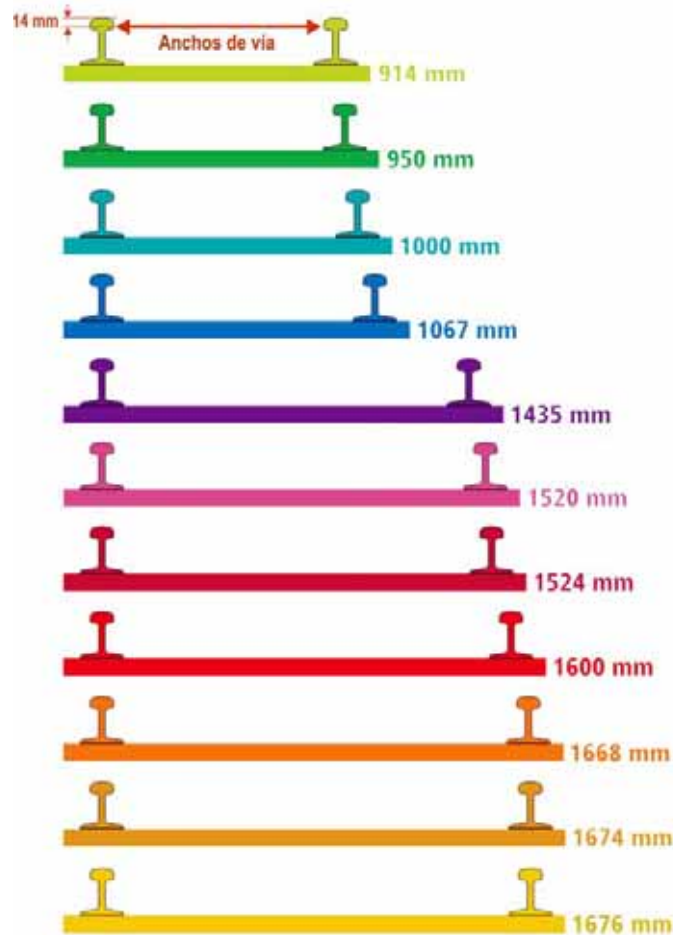

Numerous track gauges have existed and continue to exist throughout the world

In Spain, the most widespread track gauge is 1,668 millimetres, established in the 19<sup>th</sup> century (at that time six Castilian feet, equivalent to 1,674 millimetres, subsequently reduced to the 1,668 mm gauge that exists today).

This gauge is similar to the one that exists in Portugal (1,674 mm), with which it is compatible, which is why this track gauge is often called the “Iberian gauge”, this being the name that we will use in this document.

The most widespread track gauge in the world is the 1,435 mm “standard gauge” or “international gauge” (sometimes also known as the “UIC gauge”, an erroneous name given that the International Union of Railways - UIC - encompasses railways with all the different track gauges). The new Spanish



high-speed lines, like those throughout the rest of the world, are built to the standard gauge, which makes them different from the rest of the Spanish lines.

The “standard gauge” of 1,435 millimetres establishes the distinction between two categories of railways:

- “Broad gauge” railways, whose gauge exceeds 1,435 millimetres, including Spanish, Portuguese, Russian, Finnish and Indian railways and those of numerous Latin American countries;
- “Narrow gauge” railways, whose track gauge is equal to or less than 1 metre and which exist as a complementary (or even the main) network in many countries throughout the world. Among the “narrow track” gauges, the most widespread is the “metric gauge” (1,000 millimetres and other similar gauges such as 1,067 or 1,070 millimetres), which is found on numerous lines in Spain and all over the world; but there are also other gauges such as 750 mm and 600 mm, as well as others that are expressed in inches.

The track gauge has traditionally been used as a means of classifying lines, in that to a certain extent it determines their performances. But above all, segmentation has been due to the fact that different track gauges have established a technical border between networks that traditionally has prevented trains equipped with a certain gauge from entering another network. For a detailed analysis of the problems arising from the association between track gauge and railway line management assignation, summed up in the case of the creation of Renfe in 1941, see García Álvarez, 2004 and Olaizola, 2006.

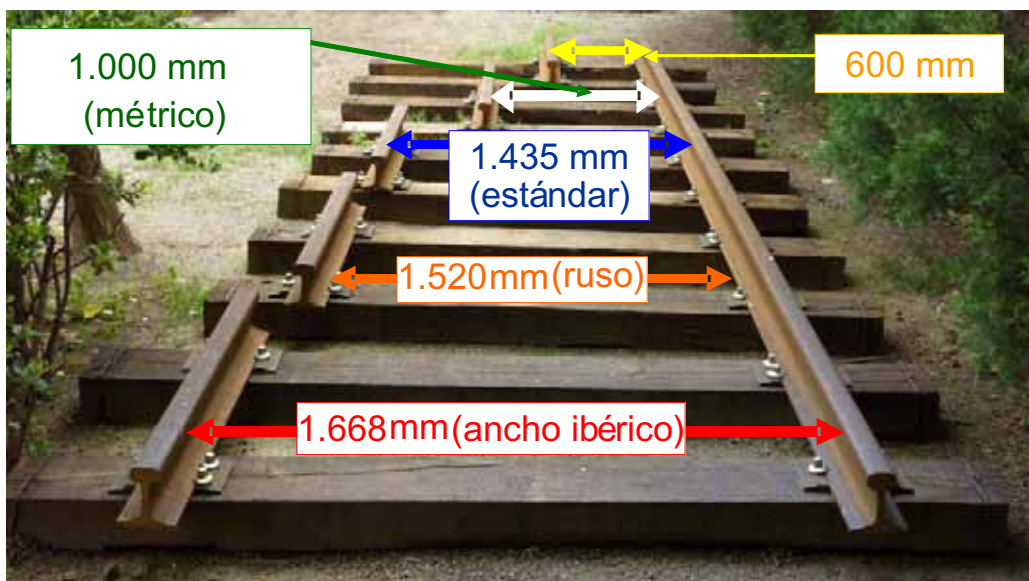

Photo showing different track gauges - ranging from the Iberian gauge (1,668mm) to the 600 mm gauge - on display at the Museu del Ferrocarril de Vilanova i la Geltrú

---

---

## Track gauges throughout the world

---

The most widespread track gauge in the world, as we have already mentioned, is the “standard gauge” of 1,435 millimetres, which is the predominant gauge in most countries and the one that accounts for nearly 50% of the world rail network.

The standard gauge is also the predominant gauge in most of Europe (France, Germany, Italy, Greece, England, Poland, Switzerland, Austria, Denmark, Sweden, Norway, etc). It is also the most widespread in the United States, Canada, Mexico and North Africa.

---

### Track gauges throughout the world

---

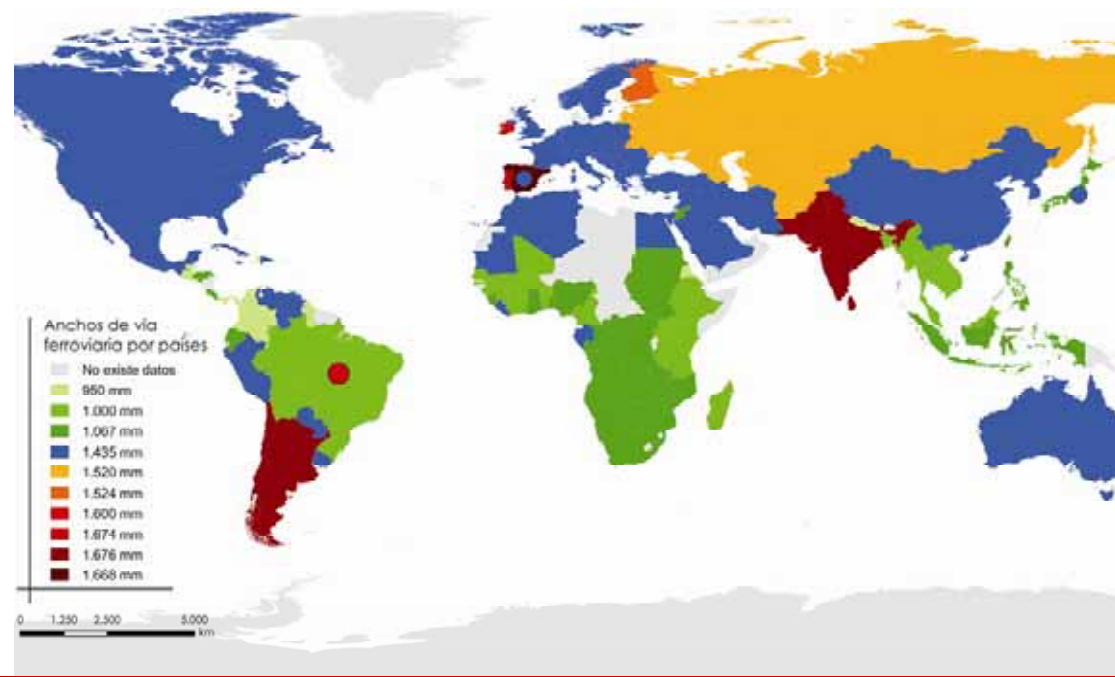

Broader track gauges exist in Estonia, Latvia, Lithuania, Russia and several other countries of the former USSR (1,520 mm); in Finland (1,524 mm); in Ireland, Brazil and Australia (1,600 mm); in Spain and Portugal (1,668 mm, 1,674 mm); and in Argentina, Chile, Bangladesh and Pakistan (1,678 mm).

Narrower track gauges exist in numerous countries throughout the world, although they generally coexist with the normal gauge of each particular country. A notable exception is Japan, where (with the exception of the standard gauge high-speed lines) the conventional national rail network has a track gauge of 1,067 millimetres.

## Track gauges throughout the Europe

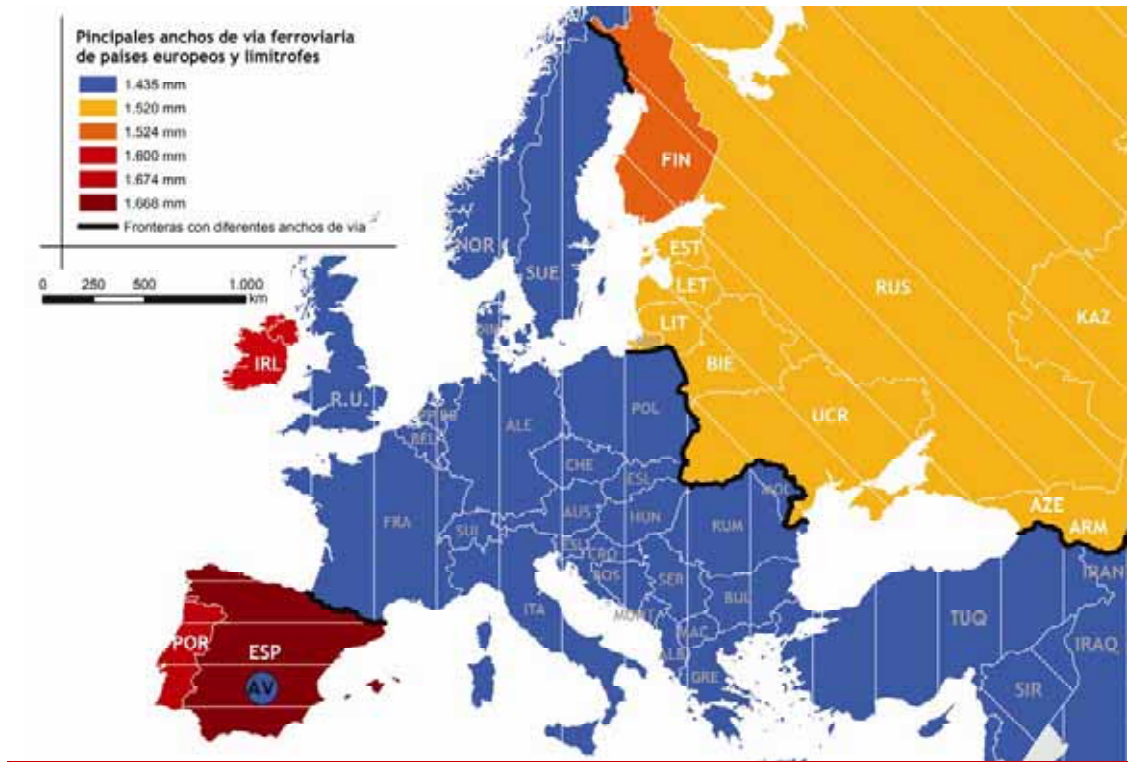

## Track gauges in Spain

In Spain, at present, there are three main groups of track gauges:

1. Iberian gauge lines (1,668 mm), which constitute the basic Spanish network operated by Adif; certain specific lines (such as the Arcelor branch lines in Asturias, industry tracks to power stations in Andorra or Meirama, port access lines and numerous private track sections). It also equips the Catalanian Government's Lleida-La Pobla de Segur line. This gauge is very similar to the one that exists in Portugal and on line 1 of the Barcelona metro network, which means that there is no gauge interruption on the borders with these networks.

2. The standard track gauge (1,435 mm), which equips the new high-speed lines, a Catalanian Government Railways (Ferrocarrils de la Generalitat de Catalunya, FGC) line, and metropolitan and tram lines. The track gauge in the Madrid metro network is very similar (1,445 mm).

3. The metric track gauge (1,000 mm), which is the characteristic gauge of the narrow track lines throughout the Northern Spain network and the Cartagena-Los Nietos line (managed by FEVE), as well as on the rest of the FGC lines and those operated by Basque Railways (Ferrocarriles Vascos).

There are also some mixed track gauge sections in regular operation in Spain, both at border stations (Irún, Portbou, Martorell ...) and on longer sections (Olmedo to Medina del Campo, Tardienta to Huesca, Puerto de Barcelona to Papiol and Mollet and Girona to Vilamalla-Figueres).

### Track gauges in Spain



## Origin of the standard track gauge

---

The track gauge issue, perhaps because of its importance in an operating context, is one of the most debated issues in the railway sphere. Historical conjecture frequently revolves around two key questions: Why was the 1,435 mm track gauge chosen as the standard gauge?; and why is the Spanish gauge different from the one that exists in other countries?

Both questions, like many others related to track gauges and the origins of the railway system, are answered authoritatively and in detail in the key work on the subject published in Spain: Jesús Moreno's "Prehistoria del Ferrocarril" (Prehistory of the Railway"), published as an offprint in "Vía Libre" (1986) and subsequently as a book.

The first question (where does the "magic" international standard track gauge figure of 1,435 mm come from?) has often been answered by resorting to "urban legends" that refer to the width of horses' behinds in Roman times. In this respect, Jesús Moreno informs us that nearly all "tracked" roads in ancient times, prior to the railway, had a similar width of around 1.44 metres.

According to Moreno, tracks on the island of Malta (in 2000 B.C.) had a width of between 1.35 and 1.45 metres, although the width of later tracks was more uniform, varying between 1.42 and 1.44 metres. On Roman roads, the distance between tracks is precisely 1.44 metres, which leads this author to assume that carts were standardised as regards this parameter.

In relation to the origin of the railway gauge, the same author indicates that it dates back to the wooden carriages of the "Tyne railway school". When George Stephenson started constructing the first steam locomotive on the tracks of Killingworth Colliery in 1814, the pre-railway track gauge that existed there was 1.422 metres (4 feet 8 inches); and being an eminently practical man, Stephenson did not call this gauge into question, but instead accepted it as just one of the many parameters that would have to be taken into consideration. Later, when he continued his career on the Stockton and Darlington Railway, he stuck to the same gauge. When he was appointed engineer to the Liverpool and Manchester Railway, he added half an inch to the gauge of preceding lines in order to increase the track play, since the distance between the wheels of the vehicles was still the same as on previous lines.

Jesús Moreno grants the Stephensons (father and son) the undeniable distinction of having ushered in a new railway era in 1830, but cannot avoid bemoaning two legacies which he describes as "unfortunate": one of them is the "normal" track gauge, the result of force of habit and a misguided pragmatism rather than serious and thought-out analysis; the other is "the reduced track spacing that prevents the clearance gauge from being given the width needed to meet the requirements of modern-day transport". He adds that "the arguments about track gauge that persisted *ad nauseam* throughout

*Automatic track gauge changeover for trains in Spain*

*Alberto García Álvarez*

the 19<sup>th</sup> century are not significant today, but in certain cases the width and height of the clearance gauge remains an insurmountable barrier”.



The origin of the track gauge dates back to the first horse-drawn vehicles

## **The peculiarity of the Spanish track gauge**

---

It has been speculated that the Spanish track gauge (six Castilian feet) was adopted for military reasons in order to prevent a French invasion. However, Jesús Moreno's work seems to prove that it was the result of a technical error, which the author attributes to José Subercasse. In fact, the current track gauge arose from the decisions made by a commission that was set up to inform the private companies that applied for railway construction and operation concessions. On 17<sup>th</sup> October 1844, this commission sent the Government a *set of specifications*, suggesting that, in the absence of legislation on this matter, it could serve as a basis for future action in this field of activity. And so the government adopted it in the Royal Order of 31<sup>st</sup> December 1844. Many of the conditions were identical to those of the French specifications, except that the track gauge was set at 6 feet (1.674 metres) and the track spacing at 6.5 feet (1.81 metres).

### **The shift from the 1,674 mm gauge to the 1,668 mm gauge in Spain**

---

The Iberian gauge of six Castilian feet, established in 1844, corresponds to 1,674 millimetres. However, the official nominal track gauge in Spain is currently 1,668 millimetres.

Of course, both track gauges are compatible, as is proved by the fact that at present (2008), there are lines in Spain with a track gauge of 1,674 millimetres on which Iberian gauge trains run without any problems. Therefore, it is worth asking the following question: Why and when was the track gauge officially changed?

The reason can be found in the report entitled "*Reducción del juego de vía*" ("Track Play Reduction"), which was included in an internal document (dated March 1955) produced by Renfe's Department of Studies and Reconstruction, and which explains the need to reduce the "track play", i.e. the clearance between the wheel flanges and the rails.

This document states that, once it had been verified that reducing the "track play" to a certain limit improved running conditions, the 1,440 and 1,445 mm track gauges used by certain (foreign) railway companies were abandoned in favour of the 1,435 mm gauge ("Unite Technique", 1903 and 1938 versions). With this track gauge, the theoretical play (with new flanges) without widening or narrowing was 9 millimetres (1,435-1,360-2x33). The French national railway company, for the purpose of renovating tracks with concrete sleepers, had decided to apply a "track play" of 6 millimetres.

The document points out that, in 1926, the "Rolling Stock Unification Office" had decided to press coach and traction vehicle wheels on at 1,596 millimetres, and that Renfe's Rolling Stock Department subsequently set the

distance between locomotive inner wheel faces at 1,588 millimetres. This resulted in a play of 13 mm for coaches and 21 mm for locomotives; and as there were also locomotives with wheels pressed on at 1,580 mm and wagons with wheels pressed on at 1,584 mm, the plays reached values of 29 and 25 millimetres..

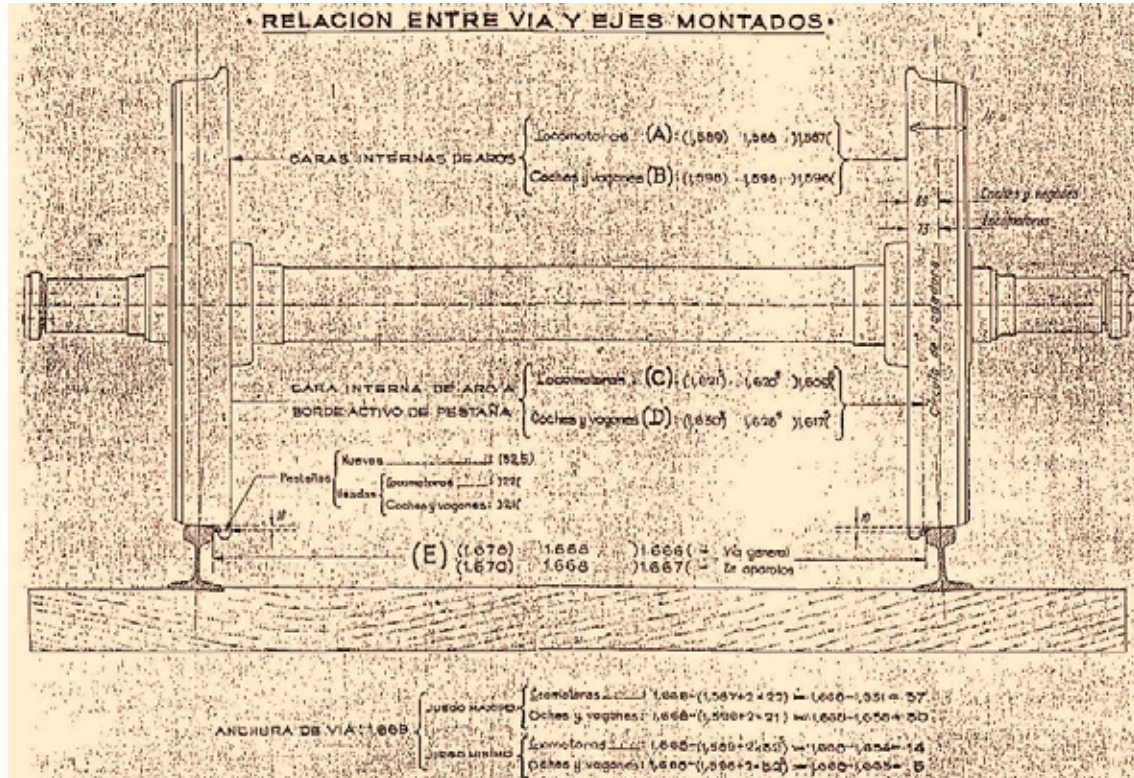

Relationship between track gauge and distance between wheels. (Source: “Track Play Reduction”, Renfe’s Department of Studies and Reconstruction, March 1995)

The author of the report considers these plays excessive and the difference between hauled stock and locomotives pointless, and therefore suggests that the play be unified at 7 millimetres for all vehicles, 1 mm more than the track play approved by SNCF for the renovation of tracks with concrete sleepers.

The document includes various technical considerations of the utmost interest regarding the effect that different amounts of play reduction would have on crossing frogs, on sleepers, and on the protection of wing rails.

The author of the report reaches the following conclusion: “the reduction of Renfe’s current track play to limits similar to those which currently exist on foreign railways can be achieved by reducing the track gauge by 6 millimetres, so that the distance between the active edges of straight rails is 1,668 mm. Maintaining this figure in the sleepers will require reducing the space between them to 41 millimetres and altering the press-on distance in the steam locomotives with wheels pressed on less than 1,588 mm apart”. Moreover, it would be necessary to unify the distances between the wheel support point and the vehicle body, which would entail reducing the thickness of the flanges of the coupled central wheels of the large rigid-base locomotives. The track gauge could be transformed as the renovations are carried out, for which it would be necessary to reduce the space between of



the check rails that protect the switch diamonds to 40 mm, by making new types of struts and designing new sleepers with spacings of 41 mm. The author adds that if a 1,668 mm track gauge were adopted, there would be a difference of only 3 millimetres in relation to the Portuguese gauge (1,665 mm), and that this gauge would reduce the track play to 7 millimetres.

Indeed, as a result of this report, Spain officially adopted the 1,668 mm track gauge, which has been applied ever since bi-block and monoblock concrete sleepers began to be used for track renovations. However, on lines where the track has not been renovated since 1955, the previous gauge still applies.

## **Track gauge changeover initiatives in Spain**

As we have already seen, the introduction of the Iberian gauge immediately sparked an ongoing discussion about the advisability of reducing it to the standard gauge (then known as “normal”). However, as the 19<sup>th</sup> century wore on, the debate gradually died down due to the expansion of the network (and the consequent increase in costs and disadvantages that a change of gauge would entail). Thus, in 1904 the railway reached the last few provincial capitals on the Peninsula, leaving most of the completed network with a different track gauge to the one that existed in France.



On the three-rail track we can see the difference between the standard gauge (1,435mm) and the Iberian gauge (1,668mm). The photo was taken at Pozal de Gallinas, on the Olmedo-Medina del Campo test section

This border problem was “solved” by the overlapping of standard gauge and Iberian gauge tracks at the border stations (Irún-Hendaya and Port Bou-

Cerbere), the goods and the few passengers in international transit being transferred from one train to another.

A similar solution was implemented (1922) at the Puigcerdá - La Tour de Carol border crossing. Then, at Canfranc (1928), the only French track reached the Spanish station, where passengers and goods were transferred.

### Track gauges in Spain (1984)



Prior to the closure of lines in 1985 and the introduction of high speed, the Iberian gauge was far and away the most widespread track gauge in Spain

However, the idea of implementing the standard track gauge in Spain reappeared at the beginning of the 20<sup>th</sup> century in the light of plans to build a standard-gauge line between Algeciras and Irún, and over the following years much was written about the possibility of converting the line from Puigcerdá to Moncada, Barcelona and the Port of Barcelona to this gauge.

However, it was not until 1988 that a significant change occurred. In December of that year, the Council of Ministers decided that the new high-speed line from Madrid to Seville (whose construction was about to commence) would be built to the standard gauge, as would the rest of the future high-speed lines. In keeping with this decision, all the later high-speed lines (from Madrid to Barcelona and to Valladolid, from Córdoba to Málaga, from La Sagra to Toledo, and from Madrid to Levante) were built to this gauge.

2006 saw the start of a process of analysing the possible conversion of the entire Spanish network - or a considerable part of it - to the standard track gauge. This study responds to two needs:

- On the one hand, the advisability of integrating the freight railway network with the French one (and the rest of Europe), which would lead to a significant reduction in transport costs, and therefore an increase in competitiveness (for example, of Spanish ports and factories).
- And on the other, the expansion of the high-speed network (with standard track gauge) reduces the number of tracks available to conventional trains on certain corridors, either because the number of tracks cannot be increased (orographically complex areas), or because the traffic does not justify an increase in the number of tracks, even if this traffic is shared between two different track gauges.

# GAUGE CHANGEOVER SYSTEMS AND INSTALLATIONS

Gauge changeover systems encompass fixed installations called “changers” and special wheelset systems in the vehicles that allow trains to pass from a track with one gauge to another with a different gauge.

Gauge changers are, as we have already explained, the installations that allow trains to change track gauge by automatically varying the distance between the wheels as the train passes through the installation, and without the passengers having to interrupt their activity and get off the train.

Gauge changers have gradually evolved to enable trains to pass through them more quickly, and to reduce the operating costs associated with this process. In contrast to the initial run-through times of approximately half an hour, these systems have evolved to the extent that trains no longer have to stop in order to pass through the changer. Instead they simply reduce their speed while passing through, which means that, for the purposes of operation and the time taken, the passage through a changer is equivalent to a short speed limit.

Passenger trains started passing through gauge changers on 1<sup>st</sup> June 1969 (one train a day per direction). In August 2010, around 36 trains (with passengers) a day per direction use these installations in Spain.



General view of changer at Valdestillas, Valladolid. (Photo: Sara Izquierdo)

---

---

# Historical evolution of automatic gauge changers

---

## The 1966 call for tenders

---

During the 1960s, as Spain gradually became aware of the need to put an end to its international isolation and open itself up to the outside world, it was felt that the different track gauge of the railway (which at that time was still the predominant mode of transport) represented an obstacle for the mobility of travellers and for trade in goods.

Therefore, in July 1966, the National Network of Spanish Railways (Red Nacional de los Ferrocarriles Españoles - Renfe), under the auspices of the International Union of Railways (UIC), announced an international call for tenders for “Designs of bogies with variable gauge axles for passenger coaches, capable of passing directly from the Spanish gauge (1,668 mm) to the international gauge (1,435 mm), and vice versa, on passing through an appropriate fixed installation”. (1)

The designs had to be submitted before 1<sup>st</sup> April 1967 to the General Secretariat of the UIC. The international jury created for the purpose was chaired by Mr. Louis Armand (Secretary General of the UIC) and comprised Mr. Koster (President of the ORE “Office de Recherches et Essais de la UIC”), Mr. Martín (Chairman of the UIC’s stock and traction commission) and Mr. García Lomas (Vice Chairman of Renfe), with Mr. Inza (Deputy Director of Renfe) and Mr. Lafarge (Technical Adviser to the UIC) acting as technical secretaries.

The jury was joined by a Committee of Experts, chaired by Mr. Saliger (Dutch, Director of the ORE), a French engineer, a Norwegian engineer and two Spanish engineers. This Committee was in charge of carrying out the in-depth studies of the 43 solutions (2) submitted to determine their technical and economic possibilities of application on the basis of the competition rules.

At its session on 11<sup>th</sup> March 1968, the jury awarded the first two prizes, declared the third prize void, and also awarded four honorary mentions. The jury’s decision was made public on 23<sup>rd</sup> April (3):

First prize went to “Ateliers de Constructions Mecaniques de Vevey S.A., Vevey” (Switzerland), and second prize was won by the “Oficina General de Ingeniería, O.G.I., Seville (Spain). The honorary mentions were awarded to the Societé pour l’exploitation des brevets RAV S.A., Geneva (Switzerland), Transportmaschinen export-import (DR IV), Deutscher Innen-Und Aussenhandel, Berlin (DDR), Schindler Wagons S.A., Pratteln (Switzerland), and Patentes Talgo S.A., Madrid (Spain) for the RD (Variable Gauge) System (submitted out of competition, since the tenders requested were for wheelsets, and the Talgo system did not have an axle).

The winning VEVEY system failed to pass the trial tests, as had already occurred with other systems prior to the tender. The O.G.I system managed to

pass the first phase of tests, but was subsequently abandoned for economic reasons and also undoubtedly because of the rapid implementation of the Talgo system, which immediately demonstrated its effectiveness.

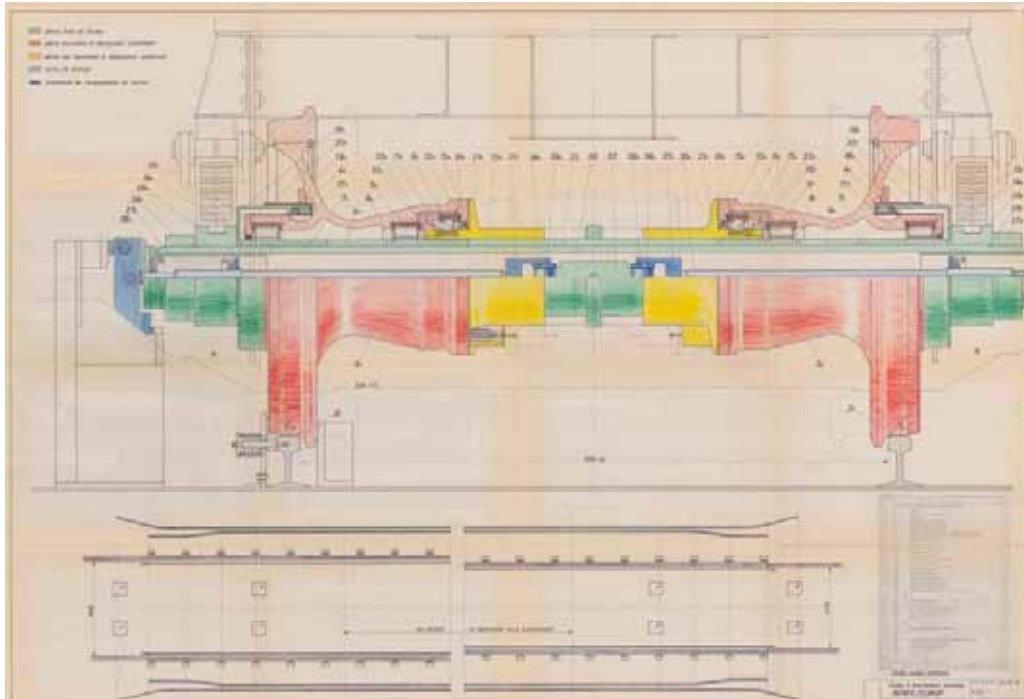

Drawing of the Vevey system

The O.G.I system managed to pass the first phase of tests, but was subsequently abandoned for economic reasons and also undoubtedly because of the rapid implementation of the Talgo system, which immediately demonstrated its effectiveness.

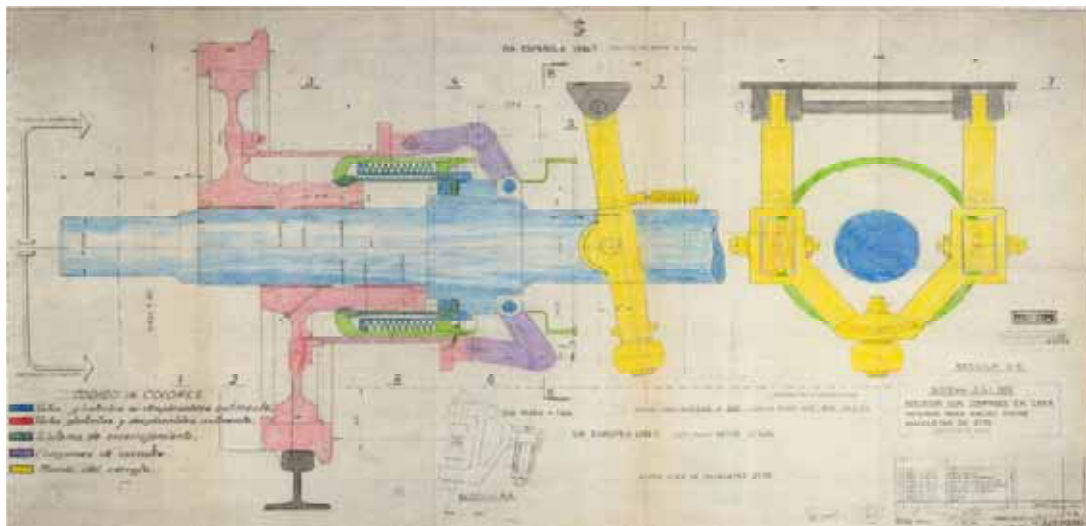

Drawing of the O.G.I system

Talgo continued to develop its design in house, and its efforts were rewarded in November 1968 when the RD system began to be used in the Pyrenees border pass.

## The Talgo RD system

The track gauge change system developed by Talgo from 1966 onwards stemmed from an attempt to enable the Spanish railway to enter France. The system was developed by Talgo's technical office under the leadership of Ángel Torán, where Boris and Uriz also played an important role, to the extent that it has been suggested that the system would not have been possible without them. After the corresponding studies and designs, the "Variable Gauge System" ("Sistema de Ruedas Desplazables" o "Rodadura Desplazable" - RD), was patented on 19<sup>th</sup> October 1966, i.e. after the Renfe and UIC competition was announced, but before the jury awarded the prizes.

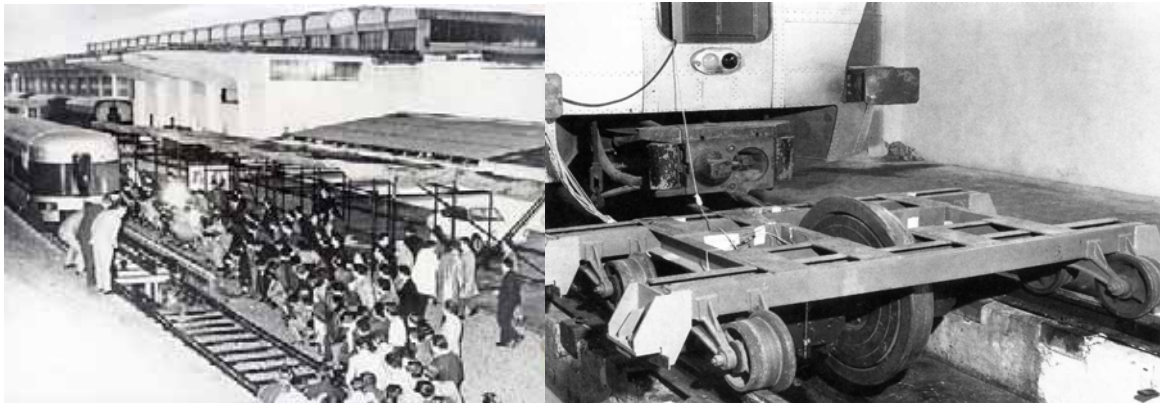

First tests of the Talgo variable gauge wheelset (RD) system in Aravaca. Photo: Talgo

1967, full-size prototypes were subjected to laboratory tests, which lasted a year (according to Miguel Cano and Manuel Galán, 2005). Following the successful completion of these tests, the RD wheelsets were installed in four international clearance gauge coaches that had been constructed by CASA at Talgo's request to form part of the experimental train, at which point the dynamic tests got under way.

The first changer (at that time called "changeover pit") was installed at the Talgo factory in Aravaca and used to perform tests on the experimental Variable Gauge (Talgo RD) train. The first "official" run-through of a train in this type of installation took place on 24<sup>th</sup> October 1967, as part of a series of tests and demonstrations that reached their climax with the experimental Talgo RD's journey from Madrid to Paris on 12<sup>th</sup> November 1968. For this first journey (and other tests performed during the following months), a changer was installed in Irún and subsequently dismantled.

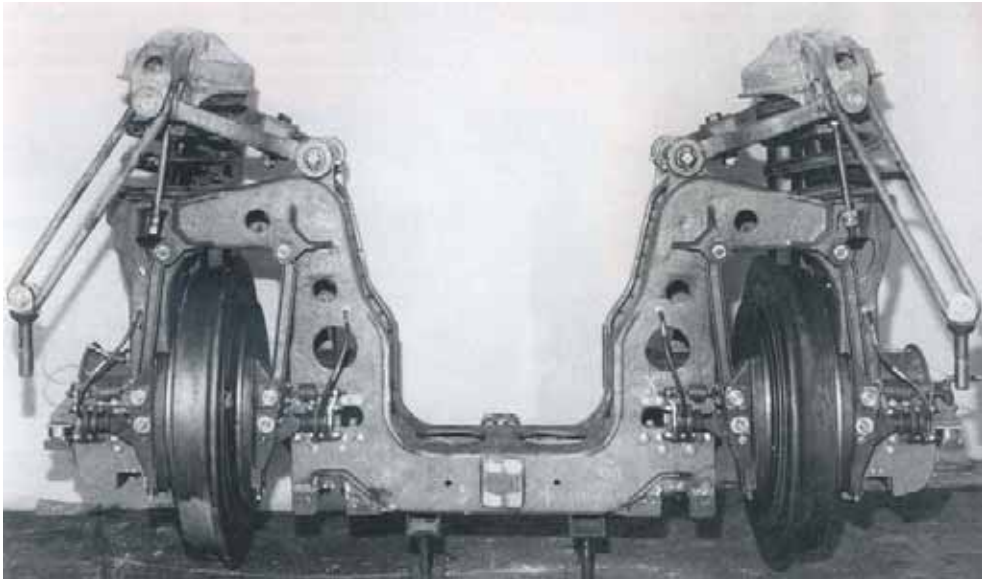

Talgo III RD variable gauge wheelset (1968). (Photo: Talgo)



---

---

## **Border changers: first generation**

---

Following the success of this - then - revolutionary experiment, Patentes Talgo manufactured the first variable gauge revenue trains (corresponding to the model called “Talgo RD”, very similar to the Talgo III but with variable gauge wheelset and “European” clearance gauge) and then constructed a changer in Port Bou (Girona), with a view to its regular operation. On 19<sup>th</sup> May 1969, the new train passed through it on a test run and entered France for the first time.



Construction of the Portbou changer (Photo: Francisco Uriz)

## **International Talgo RD trains**

---

### **Daytime trains**

On 1<sup>st</sup> June 1969, the Talgo III RD train started running regularly under the commercial name “Catalán Talgo”. It provided a direct link between Barcelona-Término and Geneva in both directions without passenger transfer, and joined the prestigious club of European “TEE” trains.

Over the next 25 years, this train continued to provide a regular service that remained unchanged except for a few changes of itinerary in France and the incorporation of second class coaches after the disappearance of the “TEE club”. On 25<sup>th</sup> September 1994, the “Catalán Talgo” was forced to shorten its route, which for then on would come to an end at Montpellier due to the expansion of the TGV network (a TGV link from Montpellier to Geneva having been created). Less than a couple of years later, on 18<sup>th</sup> May 1996, a second daytime service (called “Talgo Mediterráneo”) was established between Valencia and Montpellier, which operated with Talgo III RD rolling stock until September 1998, when it was replaced by the extended Talgo “Mare Nostrum” service, which began to cover (as it continues to do today) the Cartagena-Montpellier route with 6<sup>th</sup> generation Talgo rolling stock.



Catalán Talgo locomotives at Port Bou

On 1<sup>st</sup> June 2009, the “Catalán Talgo”, with its longstanding original Talgo III RD composition, completed 40 years of active service and continues to run daily in both directions between Barcelona-Estación de França (the current name of Término station) and Montpellier.

### **Night trains**

The “Barcelona Talgo”, which was originally a Talgo III RD sleeper train that provided daily service between Barcelona and Paris, started using the Portbou

gauge changer in May 1974. In June 1991, the rolling stock was replaced by a new series 6 Talgo Pendular RD train, which continues to run daily under the commercial name of “Joan Miró”, operated by the SNCF-RENFE joint venture “Elipsos”.



On 25<sup>th</sup> May 1981, another changer was put into service at Irún to cater for the Talgo RD train (in this case it was a Talgo Pendular train belonging to the new series 5) that covered the Madrid-Paris route in 13 hours. This train continues to run today (since 1990 with series 6 Talgo rolling stock) under the name of “Francisco de Goya”, also operated by “Elipsos”.

In 1989, a new Talgo night train service was established from Barcelona to Milan and Berne (subsequently extended to Zurich). Although this train initially provided a daily service, it now only runs daily during peak traffic periods, and three times a week during the winter months.

### **International services in 2009**

In 2009, the Portbou border installation is used by two daytime trains (the Talgo III RD from Barcelona to Montpellier and the series 6 Talgo “Mare Nostrum” from Cartagena to Montpellier), as well as by the overnight Talgos from Barcelona to Paris (daily) and from Barcelona to Milan and Zurich (three times a week in winter and daily in summer).

Since 1981, the Irún installation has been used by the “Francisco de Goya” TrenHotel (Talgo 6) from Madrid-Chamartín to Paris, which currently stops at Valladolid, although for many years it used to pass through Aranda de Duero.

## Operation of border changers

The first track gauge changers were installed, as we have already mentioned, on the French-Spanish borders for the benefit of Talgo Variable Gauge (Rodadura Desplazable - RD) trains, in which the gauge of the Talgo technology trailers (but not the locomotives) equipped with this system can be changed. The Talgo trailers whose gauge can be changed are those of RD series III and those of the Pendular (tilting) series 5, 6 and 7.

The Portbou and Irún changers still perform the function of allowing international trains to pass through. It is estimated (2010) that more than 88.514 trains have passed through the Portbou installation without any incident of note.

Together with these border changers for revenue trains, other changers were installed at the Talgo maintenance bases to verify the functioning of the system: one at Barcelona-Pueblo Nuevo (later transferred when the Talgo Workshop was moved to San Andrés Condal, where it remains), and another at Las Matas, when this base was built (1980). The first changer for the experimental train and for all the tests remained in Aravaca from 1967 until the base closed down in April 2001.

The common denominator of these “first generation” changers is that they are only suitable for Talgo trains and are only used for the hauled vehicles. The locomotives do not pass through the changer, and therefore the trains that use them must change locomotive when passing from one network another.

Tren: 00407 TRENHOTEL FRANCISCO GOYA Origen: MADRID-CHAMARTIN Destino: HENDAYA

N.Comercial: Observac:

Locomotora	Desde Estación	Hasta Estación	Peso	Tipo
LOC 252	MADRID-CHAMARTIN	HENDAYA	350	100B

C	Tipo de bloque	St	Vel	Dependencia	A	Para	P	Horas	Para	Tiempo	C.
A		Klm	max	Precaución	S	Com	y	Sal-Pas	Tec	Conc	Rad
T					F		r				
		622.5	115	SAN SEBASTIAN-DO.....	A			1:19.3		2.0	
		623.1	080	GROS (APD).....	A			1:21		1.3	
		624.3	100	ATEGORRIETA (APD).....	A			1:23		2.0	
		626.2	135	HERRERA (APD).....	A			1:24.3		1.3	
		627.9	115	PASAIA.....	A			1:26		1.3	
		629.6	100	LEZO-REINTERIA.....	A			1:28		2.0	
		637.7		VENTAS DE IRUÑI (APD).....	A			1:33		5.0	
		639.4	115	IRUÑI.....	A			1:37	01	4.0	
		640.9		CAMBIADOR IRUÑI.....	A			1:42	15	4.0	

Route sheet of the Madrid-Paris Trenhotel on passing through the changer, indicating the time it takes to change gauge: 15 minutes

These changers are used by trains that cover very long distances (with journey times of around 12 hours or more), and therefore the run-through time is fairly insignificant in relation to the total journey time. Moreover, the number

of run-throughs per day is low (one train per direction and day in the case of Irún and three or four per direction and day in Portbou), which means that few resources are devoted to the changer.



Irún changer exterior and interior (1981)

The run-through takes place between two networks with different regulations (Adif and RFF), which complicates train clearance procedures, coupling and decoupling, brake tests, etc. Consequently, for many years it took nearly half an hour for trains to pass through the changer, including all the associated operations.

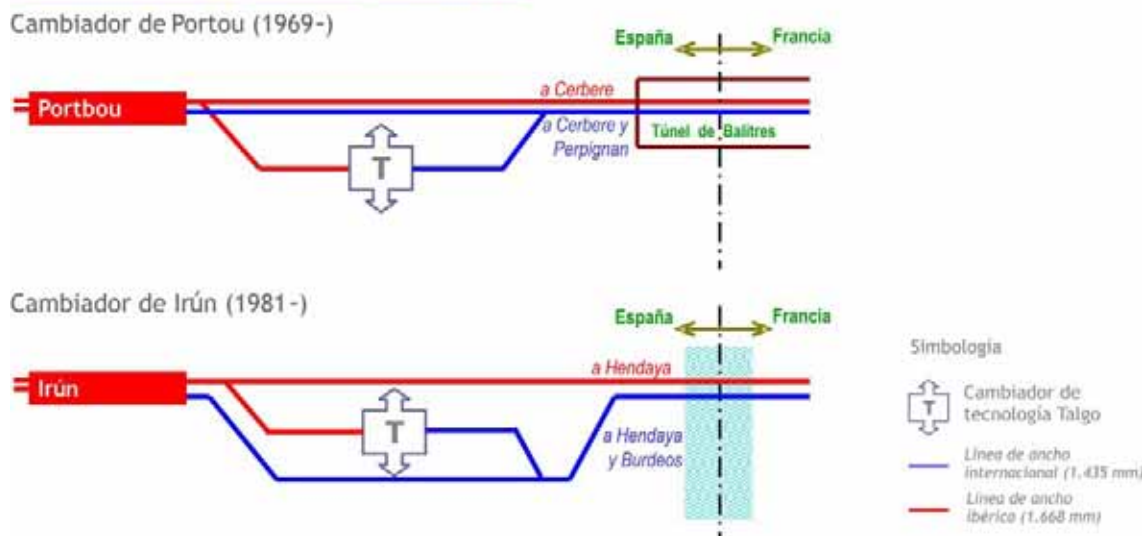

Diagram of first generation changers

Since 1999, the procedures have been simplified by allowing (due to the influence of gauge changer operation on the Madrid-Seville line) trains to pass through with the brake connected and replacing the “complete brake test” with “coupling verification”. This simplified procedure means that the train does not have to stop when it comes out of the changer, and has been used in

*Automatic track gauge changeover for trains in Spain*

*Alberto García Álvarez*

---

Portbou in both directions (reducing the run-through time to 15 minutes) since 1999, and in Irún since 2003, albeit only in the North-South direction.

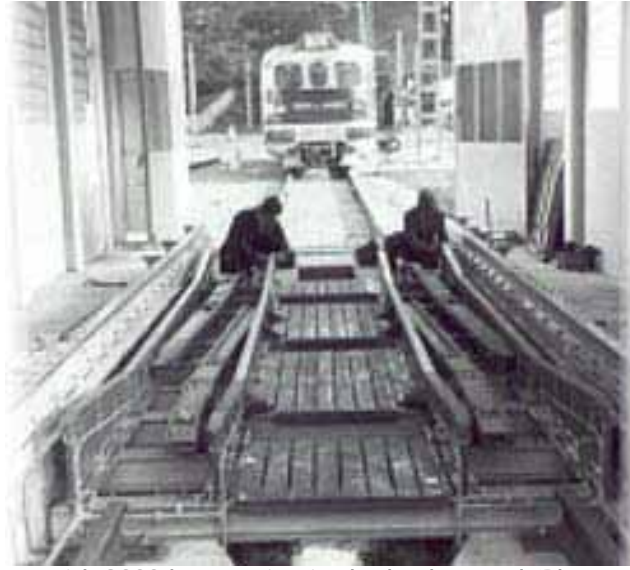

Portbou changer with 3000 locomotive in the background (Photo: Francisco Uriz)

---

## Changers on the Madrid-Seville high-speed line: second generation

---

The second generation of gauge changers emerged in response to a new need resulting from the Spanish high-speed lines having been built to the standard track gauge (1,435 mm). This gave rise to new “gauge borders” within the national network at the points where the lines of the new high-speed network coincided with the lines of the conventional Iberian gauge network.



Second generation changers in Córdoba (1994).

Coinciding with the completion of the High Speed Line (HSL) from Madrid to Seville in 1992, new gauge changers were constructed at Córdoba to allow “Talgo 200” trains to run from Madrid to Málaga and Algeciras; at Majarabique (Seville) for trains running from Madrid to Cádiz and Huelva; and at Madrid-Puerta de Atocha for the Barcelona-Seville trains and for the empty trains heading to the Talgo maintenance base in Las Matas.

The partial utilization of the Madrid-Seville HSL significantly reduced the journey time. Thus, whereas the Talgo Pendular (n° 140/141) took 6 hours and 43 minutes on the conventional line from Madrid-Atocha to Málaga at the beginning of 1992, the variable gauge “Talgo 200”, which started running on the high-speed line on 31<sup>st</sup> May 1992, passing through the Córdoba changer en route, was able to complete the same journey in 4 hours and 54 minutes. A second daily service in both directions was introduced on 21<sup>st</sup> June 1992, and on 18<sup>th</sup> April 1994 the frequency was increased to three a day, with a journey time of 4 hours and 35 minutes. These trains eventually offered six services a

day in both directions with journey times of 4 hours-plus, which were reduced to just over 3½ hours when the new high-speed section from Córdoba to Antequera entered into operation in 2006. At the end of 2007, they gave way to the AVE trains when the final section to Málaga was opened.



In the second-generation gauge changers, it is necessary to change the locomotive. The photo shows an electric locomotive 252 and a diesel locomotive 319 passing through the Córdoba gauge changer (1994).

A new service was introduced on 31<sup>st</sup> May 1992: the Talgo “Triana” from Barcelona to Seville, which entered the HSL through the new Madrid changer and covered the route in 11 hours and 9 minutes, as compared with the previous journey time of 14 hours. Almost throughout its operating lifetime, the “Triana”, which ran until the high-speed line reached Barcelona in 2008 (when it was replaced by an AVE), was Renfe’s highest revenue-earning and most profitable train.

26<sup>th</sup> July 1993 saw the opening of the gauge changer at Majarabique on the outskirts of Seville, which reduced the journey time of the Madrid Atocha-Cádiz Talgo from 7 hours and 29 minutes to approximately 5 hours; and from 1<sup>st</sup> August of the same year, the changer was also used by the Madrid-Huelva Talgo, cutting the journey time from 7 hours and 26 minutes to 5 hours. Furthermore, the Talgo Triana’s route was extended to Cádiz.

## **Reducing gauge changeover times and costs**

---

These gauge changers associated with high-speed lines have to meet more demanding requirements as regards run-through times, given that they are used by daytime trains with journey times of around 4 or 5 hours, which makes it important to reduce the time it takes for the train to pass through the changer. Moreover, as these trains provide high-frequency services, it is also important to reduce the resources needed to operate the changers. Therefore, these changers differ from their first-generation counterparts in terms of how they perform the operations, whose speed and efficiency were



considerably improved by the process re-engineering work carried out from 1994 to 1997 to reduce run-through times and costs.

This work was carried out on two fronts. Firstly, the operations were redefined, making sure that it was possible for trains to pass through without using the “Auxin plug” (whose purpose is to prevent the coaches from braking as the train passes through the changer, although the locomotive *can* brake). This French requirement in border operations had been put into practice on the Madrid-Seville line, but it was soon discovered that it could be substituted by the engine driver’s expertise. The brake test was also simplified (as explained in the description of the border changers’ operating procedure), the “complete test” (also imported from the French borders) being replaced by the “coupling verification”. This, together with the shunting crew being equipped with radiotelephones, train clearance when the rear coaches are still in the changer (thus avoiding an unnecessary stop when the last coach comes out), and the exhaustive training and collaboration of shunting personnel, has reduced the run-through and locomotive change time from 20 minutes to 9 minutes. This time is regularly achieved in the Córdoba changer, although on numerous occasions the whole operation has been completed in 6½ minutes.

Secondly, the high costs involved in using a locomotive or traction vehicle at each end of the changer to push the train (after decoupling the train’s locomotive) were reduced by performing gravity shunting operation in the changers with suitable track profiles.

This new way of operating required the installation of adjustable air brake heads in the first coach of the Talgo train. Once the locomotive has been detached, an engine driver climbs into the first coach and uses this brake head to release the brakes and regulate the forward movement until the coach stops at a predetermined point depending on the length of the train, where the brake is released again so that the first coach passes through the changer at the appropriate speed (about 10 km/h) and joins up with the locomotive waiting on the other side.

On this line, gravity shunting was possible at Madrid-Puerta de Atocha and Córdoba in the North-South direction, and at Majarabique in the South-North direction.

However, once the changer has been built, it is not possible to significantly change the track profile. Therefore, in the changers that do not offer the minimum gradient for gravity-assisted run-through (which is 4 to 6 ‰), the train is moved by some “shunting cars” that roll along the foot of the rail and rise up, trapping a wheel and carrying it until it passes through the changer. This system, which began to be used in the Talgo workshops, was installed on the north side of the Majarabique changer and then on the south side of the Lleida changer. It should be pointed out that the use of these shunting cars reduces costs by rendering an auxiliary “pushing” locomotive unnecessary, but the time is slightly increased (2-3 minutes) by having to couple the cars and push them at very low speed.

*Automatic track gauge changeover for trains in Spain*

*Alberto García Álvarez*

Tren: 09140 TALGO 200

Origen: PTA. DE ATOCHA Destino: MARIA ZAMBRANO

N.Comercial:

Observac:

Locomotora	Desde Estación	Hasta Estación	Peso	Tipo
LOC 252	PTA. DE ATOCHA	CABDOR ANTEQUERA	191	200
LOC 260-	CABDOR ANTEQUERA	MARIA ZAMBRANO	191	160B

C A T	Tipo de bloqueo	Sit Klm	Vel max	Dependencia Precaución	A S F	Para Com	P e r	Horas Sal-Pas	Para Tec	Tmpo Conc	C. Rad
		358.0		BIF. MALAGA-A.V.....	C			22:18.3		4.0	
		000.8		EM. 0,804.....	A			22:19		.3	
		002.1		EM. 2,144.....	A			22:19.3		.3	
		007.7	200	LA MAROTA.....	A			22:22		2.3	
		034.6		SANTARILLA.....	A			22:30.3		8.3	
		061.4		PUENTE GENIL-HER.....	A			22:39		8.3	
		096.8		ANTEQUER-STA ANA.....	A			22:50.3		11.3	
	BCA	000.4		CABDOR ANTEQUERA.....	A			22:52	09	1.3	
		050.4	050	A-S ANA-AGJ 50,4.....	A			23:03.3		2.3	
		123.1		BOBADILLA.....	A			23:06.3		3.0	
		131.7	155	GORANTES.....	A			23:12		5.3	

In the Antequera changer it takes 9 minutes to change the gauge

However, experience shows that shunting cars offer limited reliability, and that the shunting car-foot of rail interaction excessively accelerates the wear of both. Furthermore, this type of installation is susceptible to failure in extreme weather conditions (in summer due to overheating and in winter due to freezing of the articulated chain that houses the control and power supply wiring), all of which means that, wherever they are installed, it is essential to carefully monitor their functioning and provide for alternative measures in case of failure.

In Córdoba and Madrid, in the south-north running direction, the excessive upgrade prevents the use of shunting cars, and therefore in the first case a diesel traction unit is used, and in the second case the train's locomotive is used thanks to the peculiar configuration of the changer.

## Automatic track gauge changeover for trains in Spain

Alberto García Álvarez

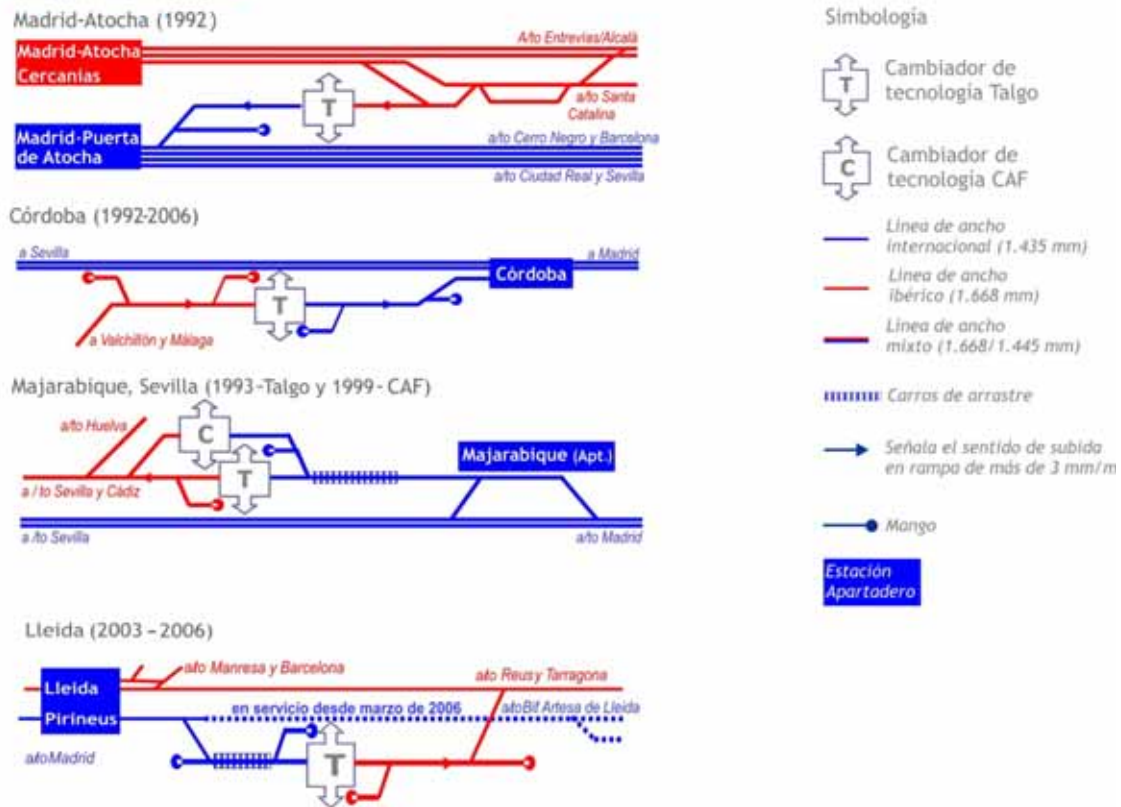

Diagram of second generation changers

## **Madrid-Barcelona high-speed line. The third generation arrives**

---

The arrival of the third generation of gauge changers is linked to the new Madrid-Barcelona high-speed line, whose characteristics inspire the changers subsequently installed on the rest of the new high-speed lines. In this case, the actual design overcomes the disadvantages and limitations detected in the previous generations; moreover, two new facts are taken into consideration:

- The appearance of a new gauge change technology for trains, developed by CAF (the “Brava” system).
- Both the Talgo system and the CAF system allow the traction vehicles (locomotives or self-propelled trains) to pass through the changer, thus reducing the run-through time and eliminating the need for a pushing locomotive or shunting cars.

In fact, the process of designing the third-generation changers began in 1999, when it became known that Talgo had just manufactured two variable gauge diesel locomotives (which made it reasonable to assume that it would not be long before there were trains with variable gauge power cars); moreover, CAF had developed a variable gauge bogie and installed a test changer at Majarabique.

A further possibility was also offered by the fact that Talgo had constructed a “portable changer” that allowed trains to pass from the international track gauge (1,435 mm) to the Russian gauge (1,520 mm), and which had been used for demonstrations in Finland and Russia. This “portable changer”, which was attached to the existing tracks by a ramp, was abandoned in Aravaca, but it served the Gestor de Infraestructuras Ferroviarias (GIF) - which at that time was designing the new high-speed lines and their installations - as inspiration for the concept of “portability”: instead of being permanently fixed to the pit, the changer could be moved from one location to another, and could even be made compatible with changers based on other technologies.

By 1999, the accumulated experience of operating the changers on the Madrid-Seville line had led to significant improvements in operating procedures, which suggested that a redesign and experimentation process was about to begin.

## The experimental changer at Río Adaja

In 2001, in the light of these needs and possibilities, the GIF designed and constructed a new experimental gauge changer at the station called “Río Adaja”, part of the *Olmedo-Medina del Campo Test Section* (Valladolid) used to test the most important innovations, such as:

- Gauge change systems situated on a portable “platform”
- Coexistence of platforms for the Talgo and CAF technologies
- Lubrication water collection and reutilization system
- “Sunken” track profile in the areas adjacent to the changer
- Position of the gauge changer in relation to the interlock.



Top left: Talgo platform; Top right: CAF platform; bottom right: Putting the Talgo platform into position

The experience acquired in the Río Adaja gauge changer tests, in the operation of previous changers and the analysis of new requirements made it possible to define the design criteria of the third-generation changers associated with the new high-speed lines.

These requirements are included in the lengthy document entitled “Definición funcional de las instalaciones de cambio de ancho para trenes de viajeros en las nuevas líneas de Alta Velocidad” (“Functional definition of gauge changeover installations for passenger trains on new high-speed lines”), published by the GIF’s Operation Department in December 2002 and regarded

as the “handbook” that gave rise to the functional development of the new Spanish gauge changers.

## **Changers on the Madrid-Barcelona line**

These new criteria were used to design the changers that have to permit the partial utilization of the Madrid-Barcelona high-speed line in order to continue on conventional lines. These changers are located at Plasencia de Jalón, for trains from Madrid to Pamplona, Irún and Logroño, at Zaragoza- Delicias, for trains from Barcelona to northern Spain (plans to construct an additional changer at Miraflores were eventually abandoned), at Huesca, for Zaragoza-Jaca trains, and at Puigverd de Lleida, for Alvia trains from Madrid to Barcelona.

Other changers were also built for this line: one at Madrid-Santa Catalina (complementing the variable gauge train workshop), and two at Roda de Bará, which were used intensively during the period of the high-speed line’s arrival and while the section of the line leading to Barcelona was being completed (December 2006 to February 2008).

The provisional changer at Lleida, despite being on the Madrid-Barcelona line, can be considered “second generation”, given that it was designed and constructed with the same criteria as the changers on the Madrid-Seville line.



Platform of the Talgo (left) and CAF (right) changers. On the left, a vertically folding platform. On the right, huts for the portable third generation changers

## **Changers on the Madrid-Málaga high-speed line**

From 1992, a changer located about 2 kilometres south of Córdoba on the Córdoba-Málaga line (near the old “Electromecánica” siding) was used by the Madrid-Málaga “Talگو 200” trains (which ran to the city of Córdoba along the Madrid-Seville line). Subsequently, this changer was used by the Málaga branch of the Talگو sleeper from Andalusia to Barcelona, and also (from 1999) by the daytime Talگو from Madrid to Algeciras.

The (second generation) Córdoba changer had been used as a prototype for the development of the operating systems described above, but fell into disuse when the high-speed line section from the Bifurcación Almodóvar to Antequera-Santa Ana entered into operation, since all the trains that had used it started running on the high-speed line to Antequera-Santa Ana, where two third-generation dual changers were installed. These changers allowed the “Talگو 200” trains to run from Madrid to Málaga, as well as from Madrid to Algeciras (the number of services on this route being doubled from one to two), and also began to be used by the new services from Madrid to Granada (which stopped running on the conventional Despeñaperros line and started running on the high-speed line to these Antequera-Santa Ana changers).

One year after these changers had entered into service, in December 2007, the high-speed line reached Málaga, and so these Antequera changers were no longer used by the Madrid-Málaga “Talگو 200” trains, which were replaced by new AVE high-speed trains (series 102, 100 and 103) from Madrid to Málaga. Nevertheless, the Antequera changers are still used (2009) for the Talگو trains from Madrid to Algeciras and Granada.



At Antequera Santa Ana there are two dual changers (CAF and Talگو) that are used for the Madrid, Algeciras and Granada trains

## **Changers on the Madrid-Valladolid line**

---

The new high-speed line from Madrid to Valladolid and Medina del Campo is designed (unlike, for example, those from Madrid to Barcelona and Seville) as a trunk section from which branch lines will head off toward various destinations (Galicia, Asturias, Cantabria, Basque Country). The Madrid to Valladolid / Medina section is built to the standard track gauge (1,435 mm), electrified at 25 kV a.c. and suitable for very high speed, but the trains (except those that finish their journeys in Segovia, Medina or Valladolid) will have to continue their journeys on the conventional Iberian gauge lines (1,668 mm) electrified at 3 kV d.c. At an unspecified point in the future, the high-speed network will be extended northwards, either by continuing the current line (for example, from Valladolid to Palencia and León) or by constructing various new sections (“Basque Y”, Orense-Santiago, Pajares tunnels). Therefore, for many years to come, a significant proportion of the trains that run on the new line will have to be variable-gauge, in order to be able to use the standard gauge trunk section and then the conventional lines, both for long-distance services (Madrid to Valladolid and Gijón, Madrid to Medina-Galicia) and medium-distance services (Madrid to León or Madrid to Burgos and Vitoria).

Gauge changers play a fundamental role on this line, since they are not temporary solutions until the HSL reaches its destination (as is the case on the Barcelona and Málaga lines). Instead they will form part of the line’s operating strategy for many years.

This is why the line has had three commercial changers since it entered into operation in December 2007: at Madrid Chamartín, Valdestillas and Valladolid, and two more of a technical nature at Fuencarral, to which another one was added at Medina del Campo in early 2008. Future extensions of the line will make it necessary to install more changers, e.g. on the section leading out of Medina toward Salamanca and at Zamora.

It should also be mentioned that there were plans to install a CAF gauge changer in the vicinity of Matapozuelos. The infrastructure had been built, but the idea was subsequently dropped, and the Valdestillas changer was built to perform this function.

The functionality of the changers is obvious. The Madrid-Chamartín changer has two purposes: to allow the through trains from Gijón and Santander to Alicante (services which already existed and which were maintained when the HSL entered into service, with considerable journey time reductions) to pass through Madrid, and to allow variable gauge trains to leave the line and head to the Santa Catalina workshop.

The Valdestillas changer permits a better utilization of the Río Duero-Valladolid section, which temporarily consists of two single tracks (one of each gauge), thus making it necessary for certain northbound trains to change gauge at Valdestillas instead of at Valladolid and run between Valdestillas and



Valladolid on the Iberian gauge track if they are incompatible with another, international gauge train.

The Valladolid-Campo Grande changer, situated on the Cabezón (North) side of the station, allows trains heading to destinations beyond Valladolid (Talgo series 130 trains during the initial phase) to change gauge and carry on to their final destinations.

The Medina de Campo changer (situated at the entrance to the station from the old Segovia line) allows trains coming from Madrid and Olmedo on the HSL to continue toward Galicia or Salamanca; and, given the topology of the station, these trains have to change running direction.

As regards the types of changers on this line, all of them belong to what has been called the “third generation”; i.e. they are suitable for self-propelled trains (since they have catenary); they generally allow gravity shunting; and they can be used by Talgo trains and CAF trains, with the exception of the Madrid-Fuencarral changers, which are not dual, one being a Talgo changer and the other having CAF technology.

### **Changing platforms by horizontal movement**

The changers on the Madrid-Valladolid line have some innovative features. In this respect, the Valdestillas, Madrid-Chamartín and Medina changers are perhaps the most significant, in that being dual changers suitable for Talgo and CAF trains, the platforms are changed by horizontal movement, as opposed to the vertically folding platforms in other changers (Río Adaja, Plasencia, Roda, Antequera ...). The new system (which could be described as “dual-horizontal”, and which is actually called TCRS-2) is patented by Adif (as is the earlier “dual fold-away” changer). In this system, the two platforms (Talgo and CAF) are at ground level and one of them is aligned with the main tracks. Depending on the technology of the train that is going to pass through, the double-platform assembly is pushed sideways until the appropriate platform (CAF or Talgo) is in the required position. This system requires more ground space (which is why it has not been possible to use it in Valladolid), but on the other hand it is more economical, simpler and more reliable.

The special characteristics of each one of the changers on the lines are as follows:

- Madrid-Chamartín: Dual horizontal; sunken track profile (gradient on both sides); with de-icers and without handles.
- Valdestillas: Dual horizontal; sunken profile; with de-icer and with handles.
- Valladolid: Dual fold-away; profile with gradient on both sides toward Valladolid; with de-icers and with handles.
- Medina del Campo: Dual horizontal; profile with gradient toward Medina; with handle on Segovia side; with Iberian gauge bypass for work trains.

- Fuencarral I and II. They are not dual changers (one is a Talgo changers and the other has CAF technology). They are only used for movements to the workshop.



Top left: Valdestillas changer; top right: Madrid Chamartín changer under construction; bottom left: Valdestillas; and bottom right: Valladolid changer

## **Changers on the Madrid-Levante line**

The first part of the high-speed line from Madrid to Levante enters into service in 2010 between Madrid and Valencia and the branch line to Albacete. In this section two gauge changers are included.

- Valencia HS gauge changer: Situated on the South side of the Iberian gauge tracks of the new Valencia High-Speed station. It is a dual fold-away changer which allows trains travelling from Madrid to Castellón and Gandía that use the high-speed line to Valencia to pass through. This is a terminus changer, since all the trains arrive at and leave this station on the South side regardless of their track gauge.
- Albacete gauge changer: It is a dual horizontal changer which makes it possible to take advantage of the high-speed section between Madrid and Albacete in order to continue on conventional line to Alicante, for example.
- As well as these two changers for revenue trains, a provisional changer was installed at the Gabaldón base, near Albacete, to allow examination

## *Automatic track gauge changeover for trains in Spain*

*Alberto García Álvarez*

---

test trains to enter the line. This changer has Talgo technology (the one situated in Lleida was reused) and due to its temporary nature it does not have a water lubrication system.



Valencia automatic track gauge changeover for trains

(Foto: Sergio López Lara)



Albacete automatic track gauge changeover for trains

(Foto: Sergio López Lara)

## CHARACTERISTICS OF THE THIRD-GENERATION CHANGERS

As we have already indicated, third-generation automatic track gauge changers have several new technical or operating features, which will be analysed in this chapter. As these changers are more complete than those of previous generations, their description is of greater interest.



Roda de Bará changers



---

## **Modularity and portability**

---

Upon starting to design the functional characteristics of the third-generation gauge changers, it was observed that each site had different requirements. For example, a changer might be for Talgo trains, for CAF trains or for both; it might be for self-propelled trains or conventional trains (hauled by locomotive), or only for a particular type of train; de-icing of wheels may be necessary on one or on both sides, or may not be necessary at all; the selected site may or may not have an electricity and/or water supply, etc.



Portable modules containing the auxiliary systems are built next to the third generation changers

main characteristic of the third-generation changers is their “modularity”, which allows them to meet the functional requirements of each specific case. At the same time, however, they provide general solutions and can also be mass-produced.

Therefore, each changer is designed on the basis of the specific requirements it will have to meet, the necessary modules being added accordingly, always with the underlying idea of being able to change the configuration as and when requirements change, since all the subsystems are interchangeable.

Moreover, the gradual expansion of the Spanish international track gauge network suggests that, in many cases, changers might only be used for a limited period of time; they may no longer be required in a certain location, or they may be needed somewhere else. Therefore, “modularity” is complemented by “portability”, allowing the changer and its auxiliary systems to be transported to a new location and, depending on the case in question, utilizing up to 80% of the investment in a changer if its parts and components are moved to or reused in other sites.

## **Versatility**

---

Another of the differentiating characteristics of these changers is that the devices directly responsible for changing the gauge (support guides, diverging and converging rails, locking mechanisms, etc.) are not fixed or “embedded” in a pit and welded to the rail (as occurs with the first and second generation changers, including the one at Lleida). Instead, the devices are attached to a

“platform” that can be mounted, dismantled and transported. In fact, the third-generation changer “platforms” are manufactured by Patentes Talgo and CAF for their respective trains, and both can be mounted in the same pit.



The third generation changers are versatile and the platforms are superimposed on a bedplate, instead of embedded in a pit. The photo shows a Talgo platform on the left and a CAF platform on the right.

The fact that the same pit (and therefore the access tracks on both sides) is suitable for the Talgo platform, the CAF platform or for both has given rise to “dual changers” that incorporate both platforms, either of which can be placed in alignment with the track depending on the type of train that is going to pass through at any given time.

Initially, the platforms were changed by means of vertical folding (the platform turns 90° on an axis parallel to the track). This system was first used in Río Adaja (on the Olmedo-Medina test section) and was subsequently introduced at Plasencia de Jalón, Zaragoza, Roda de Bará, Antequera and Valladolid.

Later on, a new system based on the horizontal movement of platforms (patented by Adif) was implemented at Madrid-Chamartín, Valdestillas, Medina del Campo (Madrid-Valladolid HSL) and Alcolea de Córdoba. This system, which is simpler and more reliable, can only be used at locations with ground space of sufficient width, given that it requires 12 free metres as opposed to the 8 metres required by the fold-away platforms.

Modularity also implies that, even when only one platform is installed in a pit (for example, the CAF platform, because it is envisaged that only CAF trains will use it), the dimensions of the pit (16 m long, 8 m wide and 1.8 m high) and its resistance make it possible to replace this platform with another at any given time, or to add a device or piece of equipment to “dualize” the changer. Transforming a CAF changer into a Talgo changer, or vice versa, would therefore take just a few hours. The fact that the Talgo platforms are longer and heavier than CAF’s has been taken into account, and therefore the length of the pit of the third-generation changers has been adapted to the Talgo platform.

---

## Catenary

---

Another immediately apparent feature of the new changers is that the catenary passes through them, since the continuity of the contact wire must be guaranteed, because the pantographs must always be in contact with it. This requirement did not apply to the earlier changers, given that the locomotive had to be changed (even if it was electric on both sides) and did not pass through the changer, which meant that it was not necessary to maintain the continuity of the contact wire.

If the trains have variable gauge traction vehicles which, therefore, pass through the changer, it is necessary to ensure that the pantograph is not raised; although, logically, it does not take electricity (and will normally be lowered) while the train is passing through the changer. Therefore, the catenary has an insulator on each side of the changer.



On the left, overhead isolating switches at the entrance to the changer. On the right, the signal shows the change in electrification voltage

It should be borne in mind that (at least up until now) there is a one-to-one relationship between the track gauge and the electrification voltage. In other words, for the 1,435 mm gauge the catenary voltage is 25 kV a.c., and for the 1,668 mm gauge it is 3 kV d.c., which forces the train to change pantograph as it passes through the changer, the a.c. pantograph descending and the d.c. pantograph rising, or vice versa.

Unlike the traditional changers (in which it was unnecessary for the catenary to pass through the changer), the contact wire must have mechanical continuity to allow a pantograph table to slide unhindered by obstacles, as an exceptional preventive measure in case all the pantographs are not lowered (as they should be) when a self-propelled train passes through the gauge change installation.

The messenger wire can be anchored to some steel frames at the entrance and exit of the building, and the suitably insulated messenger can also pass through the changer shed.

The changer shed is 25 metres long, and a neutral (voltage-free) zone of at least 2 metres must be established on each side. In total, the neutral zone covers a surface area of approximately 4 metres.



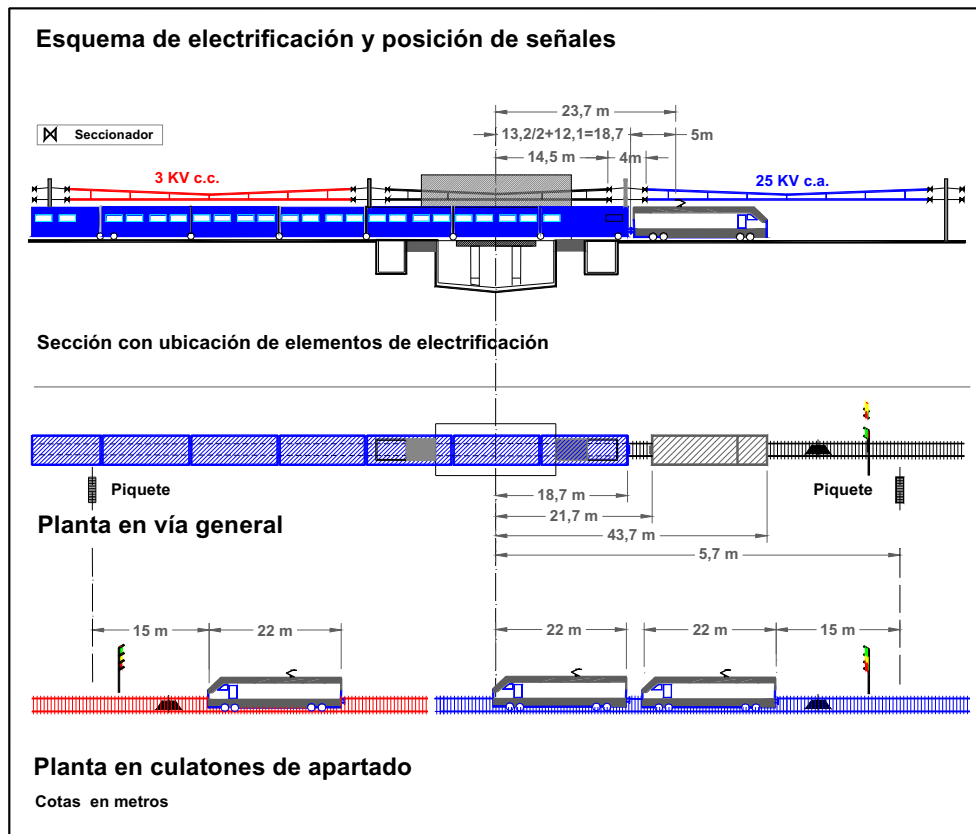

Source: Technical criteria and operating regulations. Functional definition of gauge changeover installations for passenger trains on new High-Speed lines, GIF's Operation Department, December 2002.

Electrical insulation is ensured, on each side, by two pairs of insulators (one in the contact wire and the other in the messenger wire), each one separated by a distance of approximately 4 metres, thus preventing the catenary in the changer area from receiving voltage even if the train arrives with two pantographs (electrically interconnected) raised by mistake:

- In a train with a single pantograph, current will stop entering it when the pantograph passes through the first pair of insulators.
- In a train with two pantographs, the first pantograph stops receiving current on reaching the first insulator. However, the second pantograph (if both are electrically interconnected, which is not common) may be transmitting current through the train to the first pantograph, and the latter to the contact wire now situated in a neutral zone. This current would be detected by the device situated in this area between insulators, and then the system disconnects (in the substation's tripping time). The second pair of insulators performs a protective function in this case. Therefore, the minimum distance between two pairs of insulators must be such that the train (which will run at a maximum speed of 30 km/h) passes between them in a

time that exceeds the substation's tripping time. A typical distance might be 4 metres.

Self-propelled trains that can pass through the changer must possess a pantograph control system and master switches that prevent failures caused by receiving a voltage that differs from the nominal voltage. Furthermore, they must be able to ensure that the train constantly receives power from the catenary as it passes through the changer; in other words, they must have two pantographs separated from each other by at least the length of the voltage-free zone, a typical distance being 42 m.



In the third generation changers, the catenary passes through the changer

## De-icing

Some third-generation changers include wheelset de-icing systems. When there is snow on the track, water can get into the crevices of the Talgo train wheelsets and freeze, thereby impeding the train's progress through the changer.

In cases where the train reaches a first or second generation changer with its wheelsets frozen, nozzles ("Karcher") are used manually to spray pressurized hot water on to them, but it may take up to five hours to de-ice the whole train.



Hot water control system (left) and general view of boiler (right)

To perform this operation more rapidly, pits have been equipped with automatic de-icing systems that spray the appropriate areas with pressurized hot water in a more concentrated manner, on the sides of the changers in which they are deemed necessary. The de-icing capacity to be installed (and therefore the time it takes to complete the process) depends on both the anticipated train traffic and the likelihood of the trains arriving at the changer with this problem. The Plasencia de Jalón changer was the first one to have de-icers installed on both sides, and installations of this type are also used at Roda, Antequera, Valladolid, Valdestillas, Lérida and Zaragoza-Delicias. Algunos cambiadores de la nueva generación incluyen equipos de descongelación de los rodales de los trenes. Cuando hay nieve en la vía, se puede introducir agua y congelarse en los intersticios de los rodales de los trenes Talgo, impidiendo, por ello, el paso por el cambiador.

## Automation and remote control

In the future, a large proportion of the trains that use gauge changers are likely to be self-propelled. These trains do not have to stop in order to pass through the changer, and therefore the number of operators can be reduced, possibly to the extent that no personnel will be required. For this reason, the new changers include numerous increasingly automated systems, and the most basic operations, such as changing the platforms, starting up the Talgo lubrication water system, etc, can be remotely controlled. In the dual changers, a functional relationship is established between the position of the platform and the signals that control the interlock, whereby the opening of the interlock is conditional on the signal that indicates that the platform is in the right position and locked (from this point of view, the platform behaves like a crossover which has to be in a certain verified position). This “communication” with the interlock has already been tested in the Río Adaja changer and is being applied in the changers at Roda de Bará, Antequera, Valladolid and Valdehijos.

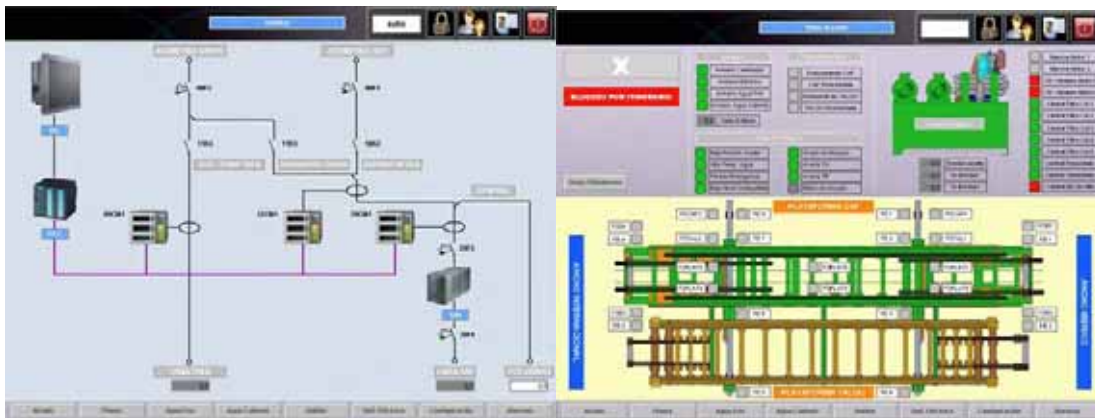

Changer system monitoring screens

Gauge changers have gone from being a passive installation, operated by personnel who supervise the run-through, to being an installation in which various processes are carried out, and which deals with numerous trains, all of which requires a high level of system reliability. To this end, special attention has been paid to redundancy: the platform change systems are hydraulically driven by electric motors operated from a company electricity supply and backed up by a generator. If the hydraulic system breaks down, it can be operated with compressed air from the train itself and also manually in case of total emergency. All the vital systems are duplicated and there are emergency connections between the subsystems.

In the case of Talgo trains, the rails that support the train units while the wheels are unweighted for the gauge changeover are lubricated with water. This means that a small quantity of water must fall while the train is passing through. If a signal authorises the train to enter the changer, when the latter is open the lubrication system must be working, and to avoid delays the signal must have been open for a certain time beforehand, which means that a lot of water is used. In the new changers, the lubrication water is fully utilized

thanks to collection, decanting, filtering and re-spraying, thereby saving water and avoiding the discharge of dirty water.



Some changers also incorporate a parameter measuring system that is used to check the distance between the inner faces of the wheels after the train has passed through the changer.

---

## Dual changers

---

Another special characteristic of the Roda and Antequera changers is that they are duplicated, i.e. there are two dual changers at each site (in Antequera they share the same shed and in Roda they occupy two different sheds). This duplication is a result of the experience acquired in operating the Córdoba changer, where it was discovered that traffic congestion problems can occur when numerous trains pass through the changer every day, and when there is a single-track section on one of the two sides of the changer.

This is due to the fact that, even if the section in which the changer is located is short (for example, 7 kilometres from Córdoba to Valchillón), as the train spends a considerable amount of time there (especially if, as occurred in Córdoba, the locomotive had to be changed), the section is occupied for a long period (17 minutes in this case), which can therefore cause train crossover delays. Therefore, at Roda de Bará and Antequera, where there is a

lot of traffic with locomotive change and single-track sections on the exit side, two changers have been installed to allow the trains to cross over in the changer area (although in the case of Antequera, surprisingly, the lack of a crossover forces the trains from both changers to converge toward a single-track section).



The double changers at Roda de Bará (in the photo) and Antequera allow trains that run in opposite directions to change gauge simultaneously

---

## **Technology and systems of the third-generation changerst**

---

The technical description of gauge changers, in all their facets, components and systems, can focus on the changers we have called “third-generation”, since, as we have already indicated, they are the most complete and advanced changers currently in operation, but (as we will see later on) fourth-generation changers are already being developed. The description will cover the systems related to the platform and track, electrical and communication installations, and complementary installations.

The dual changers at Roda de Bará are the most complete and are representative of the third-generation changers. Therefore, the description of their systems can illustrate the characteristics of these installations in a specific case that includes practically all the possible modules. The Roda changers incorporate the following installations:

## Hydraulic installation

The hydraulic installation in these changers is necessary for the platform movement and locking system. In each changer, this installation comprises:

In the changer pit:

- Hydraulic cylinders for raising platforms, rail section centering, rail section blocking and raised platform safety. The locking cylinders incorporate pilot-operated check valves.
- A manual operation panel for each changer situated in the pit, with distributors to enable the installation to be operated with the emergency control unit.
- Hydraulic plumbing installations with rigid  $\frac{3}{4}$ " bichromated steel pipes between the cylinders and the manual operation panel, and between the manual panel and the hydraulic module on the concrete slab floor.

In the prefabricated module situated on the concrete slab floor:

- Hydraulic generation system with 2 power units with 1,500 rpm 25 HP electric motor and double pump (max. pressure  $250 \text{ kg/cm}^2$ ). 1,000 litre oil tank, 4 blocks of electro-valves, oil temperature probe, oil level probe, pressure switches and clogged filter indicators.
- Emergency hydraulic generation system with 10 HP positive ignition engine and frame-mounted  $250 \text{ kg/cm}^2$  double pump adjacent to the main generation system.
- Platform movement control automaton with "ethernet" card, decentralized periphery for movement translator signals and limit switches in the pit and input/output cards for control unit signals and communications with the changer's signalling and control system.



## Electrical installation

The purpose of a changer's electrical installation is to supply and distribute electricity for the different services. There is a prefabricated module for the electrical installation containing:

- a. A 220 kVA soundproof power generating set.
- b. A low voltage switch cupboard with the Grid-Generating Set interlock, the protection devices of each circuit, the protection and output contactor of the train's power point and an automaton with "ethernet" card that receives the indications of all the items in the cupboard so that they can be monitored from the control application.
- c. An uninterruptible power supply (UPS) of 10 kW/20 min for automatons and computers.

The following installations are found outside the module:

- a. Concrete slab lighting (2 towers), changer sheds and engine driver paths, with a control unit in the surveillance module occupied by the security guard.
- b. Lighting and air-conditioning of all the modules.
- c. A power generating set (to be eliminated subsequently) to ensure redundancy during connection to the company's power network.

## **Cold water installation**

---

The cold water installation includes three subsystems:

- **General-purpose water.** The installation is situated in a prefabricated module containing a reinforced polyester 12 m<sup>3</sup> tank that is filled with clean water from the station; a 120 l/min double pump pressure unit for distribution to the different services (Talgo water, hot water and toilets). Tank filling is regulated with an ultrasonic level probe and an inlet valve.



Control system (left) and general view of water installation (right)

- **Water for Talgo lubrication.** There is an installation for each changer situated in its own prefabricated module, consisting of a reinforced polyester 12 m<sup>3</sup> tank that is filled with water from the general-purpose water tank; a 150 l/min double pump pressure unit for driving the water to the Talgo platform, a water collection pump in the lower channel of the pit, a 1,000 litre hydrocarbon decanter that empties out into a small polyester tank from which the recycled water is driven once again to the Talgo water tank. The



discharge of water to the pit is regulated by an electro-valve. The installation incorporates an automaton that manages the discharge of water to the platform when the order is given, as well as the replenishment of water in the circuit, taking into account the tank level indications (ultrasounds), the levels of the changer pit and those of the decanter. There is also a new water inlet electro-valve.

- **Water supply to toilets** for installation service personnel.

## **Wheelset de-icing installation**

The wheelset de-icing installation includes:

- **Talgo de-icing collector**, incorporating a pneumatic cylinder with guides for positioning the collector under each wheelset when it is stationary above the de-icing pit, as well as the de-icing collector with nozzles for spraying water onto the critical ice accumulation points, and a deflector plate that protects the collector.

- **Hot water production system**, capable of providing an uninterrupted supply of 440 l/min at 70°. It consists of a 1,200,000 kcal/h boiler with modulating diesel oil burner; two 1,000 kW 90/70/30/70° 26 m<sup>3</sup>/h plate heat exchangers; a 50 m<sup>3</sup>/h primary exchanger pump; a proportional 3-way electro-valve for adjusting the temperature of the secondary exchanger; some 440 l/min at 16 bar secondary exchanger impulse pumps; a 10 m<sup>3</sup> heat-insulated accumulation tank, mesh filters, temperature and pressure probes, a 3-way electro-valve for regulating the outflow and a control and command system with an automaton and a cordless controller.



Hot water control system (left) and general view of boiler (right)

## **Other systems and installations**

**Diesel oil installation.** A prefabricated module contains a 15,000 litre polyester double wall tank with inspection hole, loading, respiration and aspiration holes and electronic overflow alarm. There is also a diesel oil pump for supplying the power generating sets.

**Compressed air installation.** A 12 bar air compressor with 300 litre drum capable of providing a flow of 700 litres/min. There is a compressed air circuit that supplies the main pits, the de-icing pits, the Talgo water modules and the hot water module.

**Control installation.** There is an “ethernet” to which all the automatons are connected and which is distributed from a switch located in one of the offices. In the same office there is a desktop computer with a Siemens WinCC control and monitoring application.

**Safety installations.** The changer is equipped with a Bombardier interlock for the Iberian gauge side. The interlock on the international gauge side is located at La Pobla de Montornés and is manufactured by Dimetronic. Both interlocks incorporate the changer’s functionality, exchanging locked platform information with the changer, signalling the locked platform with an alphanumerical signal and permitting the transmission of remote-control platform positioning orders from the operator’s work station. In the changer there are some switch cupboards for governing interlock relations with a safety automaton that manages the commands and receives positioning orders. There are also some safety relay boxes situated in the pits to perform the “hardware” logic that determines which platform is locked according to the signals of the safety limit switches situated in the pits.

**Talgo parameter measurers.** There is a T2 wheel parameter measuring device at the entrance to each changer. This device measures the distance between the inner faces of the wheels of each vehicle, as well as the displacement of the axle in relation to the centre of the track.

**Video surveillance system.** A network of mobile and fixed cameras has been installed inside the changer and from there to Roda station. The camera signal and positioning wires go to the surveillance module, from where the signals are transmitted via the line’s optical fibre to the corresponding operation workstations.



# AUTOMATIC GAUGE CHANGERS IN SPAIN

Over the years, 33 gauge changers (including two double changers) for automatic track gauge changeover systems have been installed in Spain.

Of this total, seven are or have been located in maintenance workshops, six are test installations, and the rest are for revenue trains. In 2010, a total of five commercial changers have been withdrawn from service due to the reason for which they were built having disappeared.

The following map shows the location of all the commercial changers.

Gauge changers in Spain

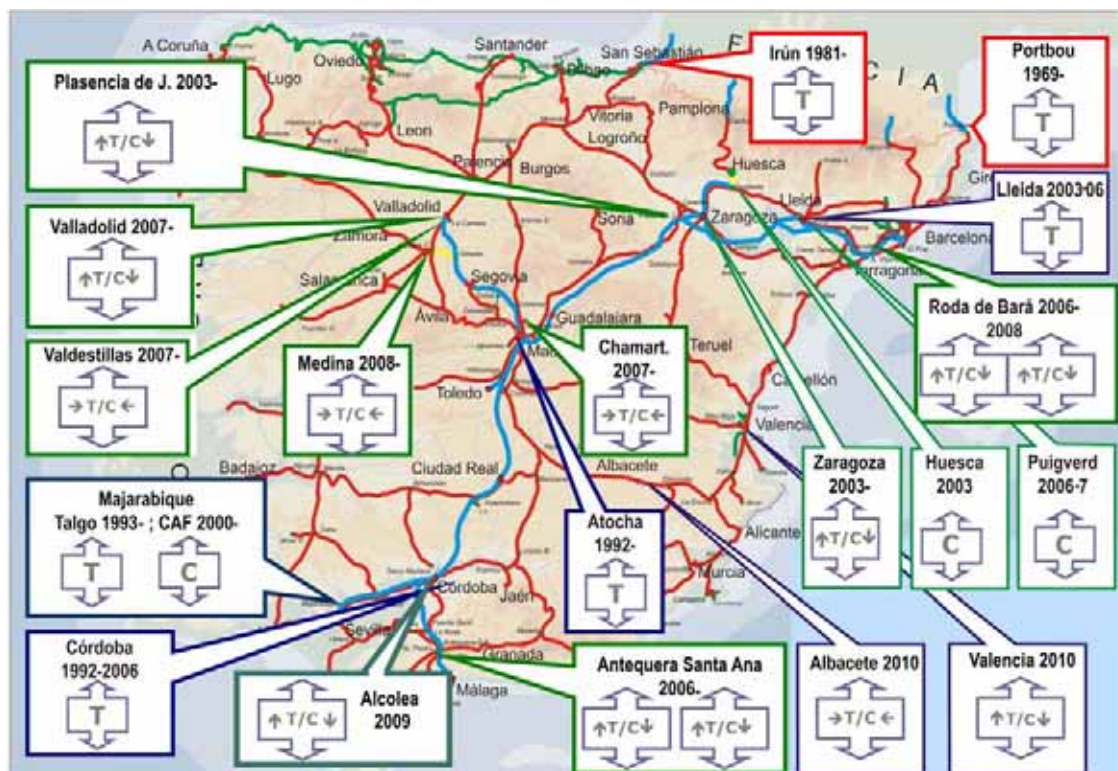

---

---

## List of changers installed in Spain

---

The five first-generation changers built for international Talgo trains are the following:

- Port Bou (Girona), 1969, Talgo technology, for international trains.
- Irún (Guipúzcoa), 1981, Talgo technology, for international trains.
- Aravaca (Madrid), 1967-2001, Talgo technology, for tests and maintenance.
- Pueblo Nuevo (Barcelona), 1969, located at Sant Andreu since 1988, Talgo technology, for maintenance.
- Las Matas (Madrid), 1980, Talgo technology, for maintenance.

The four second-generation changers installed in Spain, linked to the first high-speed lines, are:

- Madrid-Puerta de Atocha, 1992, Talgo technology for transfers to the maintenance base and national variable gauge trains.
- Córdoba, 1992-2006, Talgo technology for national variable gauge trains.
- Majarabique (Seville), 1993, Talgo technology for national variable gauge trains.
- Lledia, 2003-2006, Talgo technology for national variable gauge trains.

The third-generation changers, some of whose characteristics vary (in keeping with the characteristic modularity of this generation), are the 15 listed below:

- Río Adaja (Valladolid), 2001-2008, Talgo-CAF dual (vertical fold-away) for experimental uses.
- Plasencia de Jalón (Zaragoza), 2003, Talgo-CAF dual (fold-away with de-icing installations) for national variable gauge trains.
- Zaragoza, 2003, Talgo-CAF dual (fold-away) for transfers to the CAF maintenance base and for national variable gauge trains.
- Huesca, 2003, CAF technology, without shed, for national variable gauge trains.
- Puigverd de Lleida (Lleida), 2006-2006, CAF technology, without shed, for national variable gauge trains.
- Roda de Bará (Tarragona), 2006-2008, two Talgo-CAF dual changers (vertical fold-away) for national variable gauge trains. Since 2008, these installations, without regular use, have been used for fourth-generation experimentation purposes.

- Santa Catalina (Madrid), 2005, Talgo-CAF dual (vertical fold-away), without shed, for maintenance uses.
- Antequera-Santa Ana (Málaga), 2006, two Talgo-CAF dual changers (fold-away) for national variable gauge trains.
- Valladolid, 2007, Talgo-CAF dual (fold-away) for national variable gauge trains.
- Valdestillas, 2007, Talgo-CAF dual (horizontal change) for national variable gauge trains.
- Madrid-Chamartín, 2007, Talgo-CAF dual (horizontal change) for national variable gauge trains.
- Fuencarral (Madrid) I y II, 2008, two changers (one Talgo and one CAF) without shed, for maintenance.
- Medina del Campo (Valladolid), 2008, Talgo-CAF dual (horizontal change) for national variable gauge trains.
- Alcolea de Córdoba, 2009, Talgo-CAF dual (vertical change) for regional variable gauge trains, built by reusing parts of the sea-side Roda de Bará changer.
- Valencia, 2010, Talgo-CAF dual (vertical change) for self-propelled variable gauge trains.
- Albacete, 2010, Talgo-CAF dual (horizontal change) for self-propelled variable gauge trains.



Sequence of steps involved in changing from CAF platform (top left) to Talgo platform in a horizontal changer, in this case Valdestillas. (Photos: Ana López Romero)

Seven of the constructed changers have been removed or are no longer used: those of Aravaca and Pueblo Nuevo due to closure of their respective maintenance bases; and as regards changers for revenue trains, the following have been removed or are no longer used: those of Lleida, Puigverd de Lleida and Córdoba, in December 2006, and those of Roda de Bará, in 2008. In these cases, this has been due to the extension of the high-speed lines and, therefore, train gauge changeover in the new changers, or because the standard-gauge line has reached its destination, thus making track gauge changeover unnecessary.

The following table shows the locations of all the changers and their most important characteristics.

### Gauge changer characteristics (2010)

Changer	Operating years	Gen.	Use march 2008 / trains per day	Tecnología cambiador (1)	Nave / Pasa la catenaria	< -3 mm/m near 1435/1668	Equipo water Talgo / recircul.	Instalac. descogelac. lado 1435 /1668	Módulos instalaciones reutilizables
Aravaca	1967-2001	1	Desmantelado	Talgo F	No / No	No / no	Sí / no	No / no	N/A
Irún	1968-1968	1	Desmantelado	Talgo F	Sí / No	No / no	Sí / no	No / no	N/A
Portbou	1969-	1	T. París y otros / 7	Talgo F	Sí / No	No / no	Sí / no	No / no	N/A
Irún	1980-	1	T. París / 2	Talgo F	Sí / No	No / no	Sí / no	No / no	N/A
Barcelona-Pueblo Nuevo	1969-1988	1	Trasladado 1988 Sant A.	Talgo F	No / No	No / no	Sí / no	No / no	N/A
Las Matas I	1980	1	Taller / Workshop	Talgo F	No / No	No / no	Sí / no	No / no	N/A
Barcelona-S. Andreu Comptal	1988-	1	Taller / Workshop	Talgo F	No / No	No / no	Sí / no	No / no	N/A
Madrid-Puerta de Atocha	1992-	2	Pasos a las Matas	Talgo F	Sí / No	No / no	Sí / no	No / no	N/A
Córdoba	1992-2006	2	Sin uso	Talgo F	Sí / No	Sí / no	Sí / no	No / no	N/A
(Sevilla) Majarabique Talgo	1993-	2	T. Cádiz, Huelva/2	Talgo F	Sí / No	No / sí	Sí / no	No / no	N/A
Beasaín (factoría CAF)	1999-	-	Sin uso regular	CAF F	Sí / No	No / sí	N/A	No / no	N/A
(Sevilla) Majarabique CAF	1999-	-	Sin uso regular	CAF F	Sí / No	No / sí	N/A	No / no	N/A
Lleida	2003-2006	2	Desmantelado 2008	Talgo F	Sí / No	No / sí	Sí / no	Sí / sí	Sí
Rio Adaja	2001-	3	Desmantelado 2008	Dual / V	No / Sí	Sí / sí	Sí / sí	No / no	No
Plasencia de Jalón	2003-	3	T. Pamplona, Irún, Logroño/10	Dual / V	Sí / Sí	Sí / sí	Sí / sí	Sí / sí	No
Zaragoza-Delicias	2003-	3	Pasos TRD taller	Dual / V	Sí / Sí	Sí / sí	Sí / sí	Sí / sí	Sí
Huesca	2003-	3	TRD Zaraza-Jaca 2	CAF P	No / Sí	No / no	N/A	No / no	N/A
(Madrid) Santa Catalina	2006-	3	Taller / Workshop	Dual / V	No / Sí	Sí / sí	Sí / sí	No / no	No
Puigverd de Lleida	2006-	3	Sin uso regular	CAF P	No / Sí	Sí / sí	N/A	No / no	N/A
Roda de Bará (1)	2006-	3	Alvias Mad-Bcn+Alt. Triana/4,5	Dual / V	Sí / Sí	Sí / sí	Sí / sí	No / no	Sí
Roda de Bará (2)	2006-	3	Alvias Mad-Bcn+Alt. Triana/4,5	Dual / V	Sí / Sí	Sí / sí	Sí / sí	No / sí	Sí
Antequera-Santa Ana (1)	2006-	3	T. Mad.-Granada Algeciras / 2	Dual / V	Sí / Sí	Sí / sí	Sí / sí	Sí / sí	Sí
Antequera-Santa Ana (2)	2006-	3	T. Mad.-Granada Algeciras / 2	Dual / V	Sí / Sí	Sí / sí	Sí / sí	Sí / sí	Sí
Valdestillas	2007-	3	Alvias Madrid Norte / 4	Dual / H	Sí / Sí	Sí / sí	Sí / sí	Sí / sí	Sí
Madrid-Chamartin (Norte)	2007-	3	Alvias Alicante Norte / 4	Dual / H	Sí / Sí	Sí / sí	Sí / sí	Sí / sí	Sí
Valladolid (Norte)	2007-	3	Alvias Madrid Norte / 12	Dual / V	Sí / Sí	Sí / sí	Sí / sí	Sí / sí	Sí
Medina del Campo	2008-	3	Talgo Madrid-Galicia / 2	Dual / H	Sí / Sí	Sí / no	Sí / sí	Sí / sí	Sí
Fuencarral	2008-	3	Taller / Workshop	CAF F	Sí / Sí	No / no	N/A	No / no	No
Fuencarral	2008-	3	Taller / Workshop	Talgo F	Sí / Sí	No / no	Sí / sí	No / no	No
Alcolea de Córdoba	2009-	3	Comercial	Dual / V	Sí / Sí	No / no	Sí / sí	No / Sí	Sí
Albacete Base de Gabaldón	2009-	2	Trabajos construcción	Talgo F	No	No / no	No / no	No / no	No
Valencia AV	2010-	3	Comercial desde diciembre 2010	Dual / V	Sí / Sí	No / no	Sí / sí	Sí / -	Sí
Albacete	2010-	3	Comercial desde diciembre 2010	Dual / H	Sí / Sí	No / no	Sí / sí	Sí / sí	Sí
Figueres	2010-	2	Trabajos construcción	Talgo F	No	No / no	No / no	No / no	No

(1) F=fijo; P=Portable; Dual=Talgo+CAF, V cambio vertical; H cambio horizontal

Source: Independently produced

---

---

## **Gauge changeover operations performed in the changers**

---

As of 31<sup>st</sup> August 2010, it is estimated that 329,860 passenger-carrying trains have passed through gauge changers since they entered into commercial operation on 1<sup>st</sup> June 1969.

The table below includes the number of run-throughs made by trains in revenue service. It should be pointed out that the figures correspond to the run-throughs scheduled in the train timetables, although in some cases there may have been fewer run-throughs due to strikes, track costs or weather-related incidents. However, run-throughs for maintenance or test purposes have not been included.



## Train operations in the track gauge changers (1969-2010)

Service	Train class	Daly frequ. (Both ways)	G.Changeover	Begining	End	Number of changes
Barcelona-Ginebra ("Catalán")	Talgo RD	2	Portbou	01/06/1969	27/05/1995	18.982
Barcelona-Montpellier ("Catalán")	Talgo RD	2	Portbou	28/05/1995	31/08/2010	11.148
Valencia-Montpellier ("Talgo Mediterráneo")	Talgo RD	2	Portbou	28/05/1995	26/09/1998	2.434
Cartagena-Montpellier ("Mare Nostrum")	Talgo 6	2	Portbou	27/09/1998	31/08/2010	8.712
Barcelona-París ("Barcelona Talgo")	Talgo RD	2	Portbou	25/05/1974	25/05/1991	12.418
Barcelona-París ("Joan Miró")	Talgo 6	2	Portbou	26/05/1991	31/08/2010	14.074
Barcelona-Berna	Talgo 6	2	Portbou	28/05/1989	23/09/1989	236
Barcelona-Zurich	Talgo 6	2	Portbou	29/05/1990	28/09/1996	4.628
Barcelona Zurich	Talgo 6	0,9	Portbou	29/09/1996	30/09/2000	1.253
Barcelona-Zurich ("Pau Casals")	Talgo 6	1,1	Portbou	01/10/2000	31/08/2010	3.931
Barcelona Milán	Talgo 6	2	Portbou	24/09/1989	28/09/1996	5.122
Barcelona Milán	Talgo 6	1,1	Portbou	29/09/1996	30/09/2000	1.671
Barcelona Milán ("Salvador Dalí")	Talgo 6	1,1	Portbou	01/10/2000	31/08/2010	3.931
Tren Hotel Alpes	Talgo 6	1,0	Portbou	01/12/2003	02/01/2004	32
<b>PORTBOU</b>				<b>01/06/1969</b>	<b>31/08/2010</b>	<b>88.541</b>
Madrid-París	Talgo 5	2	Irún	31/05/1981	25/05/1991	7.292
Madrid-París ("Francisco de Goya")	Talgo 6	2	Irún	26/05/1991	31/08/2010	14.074
<b>IRÚN</b>				<b>31/05/1981</b>	<b>31/08/2010</b>	<b>21.366</b>
Madrid-Málaga (Talgo Pendular)	Talgo 6	2	Córdoba	31/05/1992	20/06/1992	40
Madrid-Málaga ("Talgo 200")	Talgo 6	4	Córdoba	21/06/1992	17/04/1994	2.660
Madrid-Málaga ("Talgo 200")	Talgo 6	6	Córdoba	18/04/1994	31/05/1995	2.448
Madrid-Málaga ("Talgo 200")	Talgo 6	12	Córdoba	31/05/1995	16/12/2006	50.604
Madrid-Algeciras ("Talgo 200" y "Altaria")	Talgo 6	2	Córdoba	31/05/1998	16/12/2006	6.242
Málaga- Barcelona	Talgo RD	2	Córdoba	20/06/1992	30/09/1992	204
Málaga Barcelona ("Antonio Machado")	Talgo 5 y 6	2	Córdoba	01/10/1992	30/09/2000	5.842
<b>CÓRDOBA</b>				<b>31/05/1992</b>	<b>16/12/2006</b>	<b>68.040</b>
Barcelona Sevilla ("Triana")	Talgo 6	2	Madrid Atocha	01/06/1992	10/10/2003	8.296
Barcelona-Sevilla ("Machado")	Talgo 6	2	Madrid Atocha	01/06/1992	30/09/2000	6.086
París-Sevilla ("Francisco de Goya")	Talgo 6	0,3	Madrid Atocha	21/06/1992	13/10/1992	33
Barcelona-Cádiz (TrenHotel 6)	TH Talgo 6	2	Madrid Atocha	26/01/2009	31/08/2010	1.164
Barcelona-Málaga (TrenHotel 6-"Gibralfaro")	TH Talgo 6	2	Madrid Atocha	26/01/2009	31/08/2010	1.164
<b>MADRID ATOCHA</b>				<b>01/06/1992</b>	<b>13/10/1992</b>	<b>16.743</b>
Madrid-Cádiz ("Talgo 200")	Talgo 6	2	Majarabique	26/07/1993	16/12/2006	9.782
Madrid-Cádiz	Talgo 7	2	Majarabique	17/12/2006	19/02/2008	858
Madrid-Cádiz	Talgo 7	4	Majarabique	20/02/2008	13/06/2009	1.916
Madrid-Cádiz ("Alvia")	130	6	Majarabique	14/06/2009	31/08/2010	2.658
Madrid -Huelva ("Talgo 200")	Talgo 6	2	Majarabique	01/08/1993	16/12/2006	9.770
Madrid Huelva ("Altaria"/"Alvia")	Talgo 6	2	Majarabique	17/12/2006	31/08/2010	2.706
Barcelona-Cádiz ("Triana")	Talgo 6	2	Majarabique	31/4/1992	22/04/2006	10.220
Barcelona-Cádiz ("Triana")	Talgo 7	2	Majarabique	23/04/2006	19/02/2008	1.334
Barcelona-Cádiz (TrenHotel 6)	Talgo TH s/6	2	Majarabique	26/01/2009	31/08/2010	1.164
<b>MAJARABIQUE (SEVILLA)</b>				<b>26/07/1993</b>	<b>31/08/2010</b>	<b>40.408</b>
Madrid-Barcelona	Talgo 7	10	Lleida	11/03/2003	16/05/2006	11.620
Madrid-Barcelona	Talgo 7	6	Lleida	17/05/2006	28/09/2006	804
Barcelona-Sevilla ("Triana")	Talgo 6	2	Lleida	11/03/2003	18/12/2006	2.756
<b>LLEDIA</b>				<b>11/03/2003</b>	<b>18/12/2006</b>	<b>15.180</b>
Madrid Pamplona ("Altaria")	Talgo 7	4	Plasencia de J.	03/01/2004	01/12/2006	4.252
Madrid Pamplona ("Altaria")	Talgo 7	6	Plasencia de J.	02/12/2006	19/02/2008	2.664
Madrid Pamplona (Hendaya) ("Alvia")	CAF s/120	8	Plasencia de J.	20/02/2008	31/08/2010	7.384
Madrid Logoño ("Altaria")	Talgo 7	2	Plasencia de J.	03/01/2004	19/02/2008	3.016

Source: Independently produced

As can be seen in the table, the longest-serving changer is the one at Portbou (40 years), which is also the most used (88,541 run-throughs), followed by the Córdoba changer (which no longer exists) with 68,040 run-throughs in 14 years and the Majarabique changer with 40,408.



## Automatic track gauge changeover for trains in Spain

Alberto García Álvarez

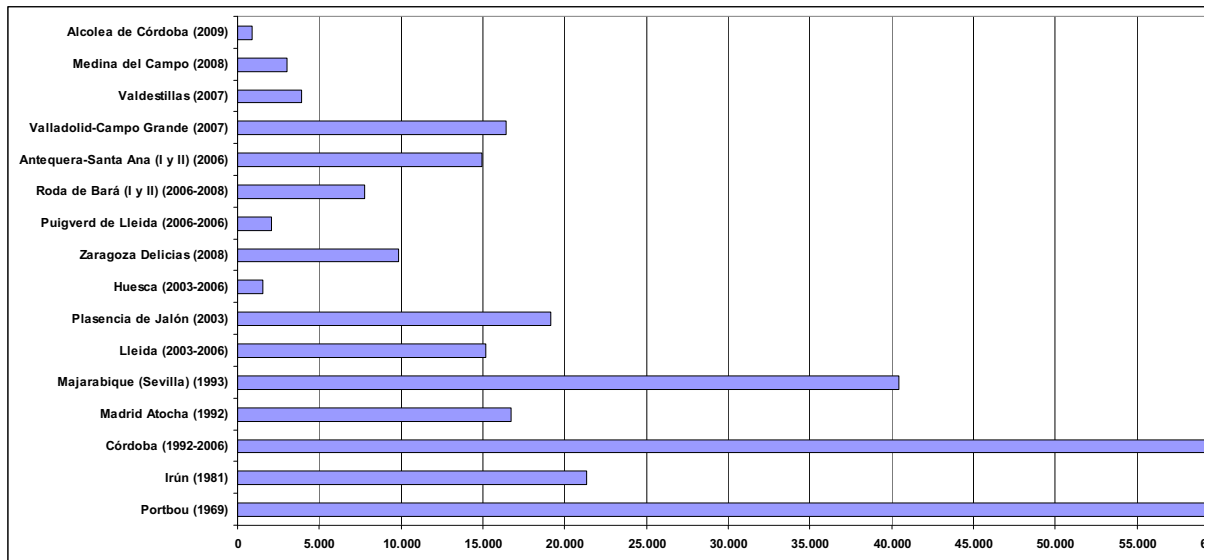

Number of run-throughs in each changer by station (1969-2010)

In terms of gauge changeover technologies, Talgo trains account for the vast majority of run-throughs (around 93.16%), which is explained by the number of years this technology has been in use (41 years as compared with seven in the case of CAF). At present, however, the number of daily run-throughs of Talgo and CAF trains is similar.



In terms of overall aggregate run-through figures, locomotive-hauled trains predominate over self-propelled trains, which is logical given the fact that the latter did not start using the changers until 2003 (CAF regional diesel trains). In fact, self-propelled trains have only been using the changers regularly and in large numbers since 2006 (CAF series 120) and 2007 (Talgo series 130). In the history of gauge changeovers, self-propelled trains represent only 9% of the total number of run-throughs, although at present (2010) they account for a considerably higher number of run-throughs in comparison with locomotive-hauled trains.

## Automatic track gauge changeover for trains in Spain

Alberto García Álvarez

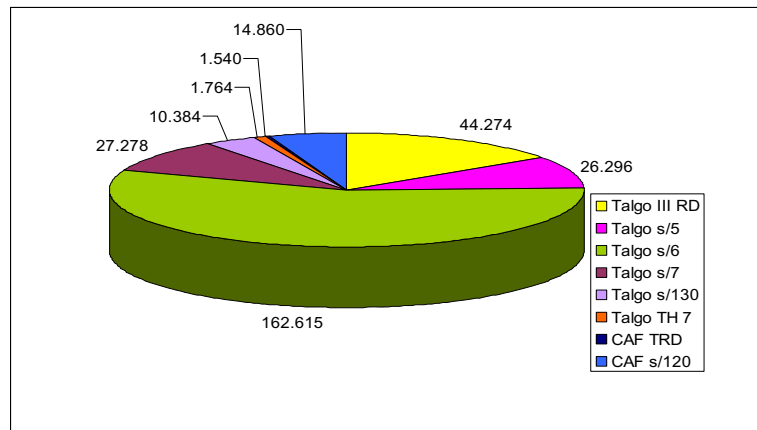

Number of run-throughs in each changer by type of rolling stock (1969-2011)

The number of run-throughs has increased considerably since the first high-speed line (Madrid-Seville) entered into operation in 1992. Since the entry into service of the first sections of the Madrid-Barcelona line in 2003, progress has been even more rapid.

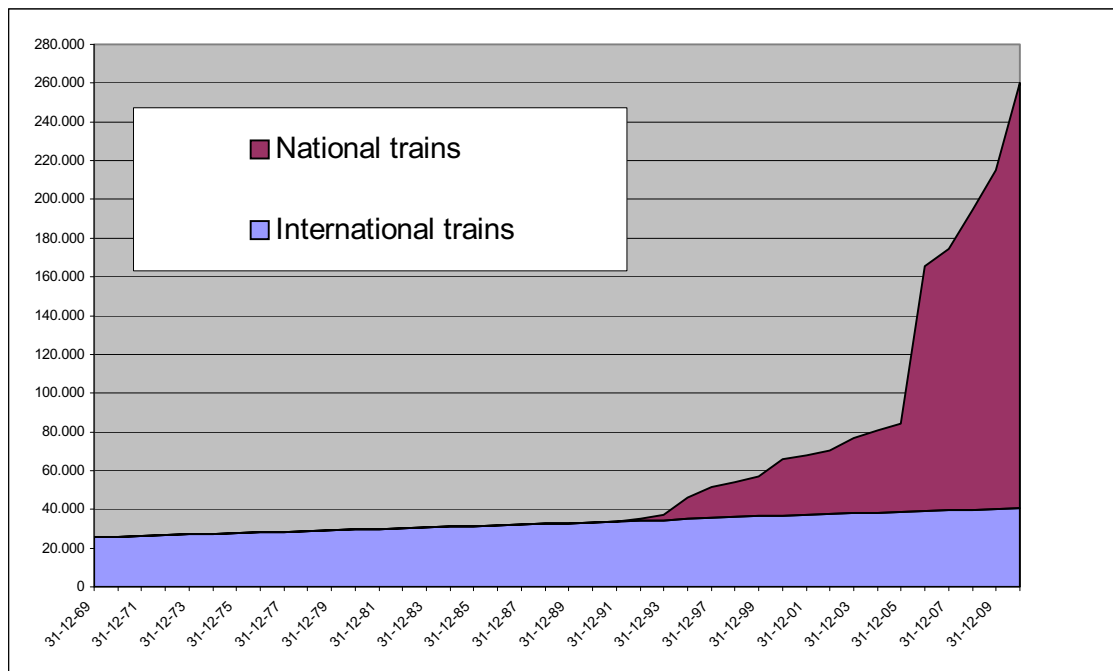



---

# VARIABLE GAUGE TRAINS AND SERVICES

As we have already explained, a wide variety of systems applied to rolling stock have been tested over the years for the switch between networks characterised by different track gauges.

In some cases, when a train reaches a border the wagon axles corresponding to a certain track gauge are unlocked and replaced with axles corresponding to the new gauge. This system has been used since the 1950s for freight trains arriving at the border towns of Irún and Portbou, thus allowing wagons loaded in Spain to reach any corner of Europe. However, this system has two disadvantages: the axle change process is slow (at least 10 minutes per axle) and also costly, because it requires skilled labour and specific installations which, if they are not duplicated, convert the border into a bottleneck, especially if the process has to be applied to a large number of trains.

In other cases, the complete bogie or truck is changed, which slightly reduces the time it takes to change gauge. This solution was used at the border with passenger trains, including the “Surexpreso” and the “Puerta del Sol”, from the 1960s to the late 1990s, allowing these trains to continue their journey without transferring passengers at the border.

A third system is based on maintaining the same axles or wheelsets and changing only the distance between the wheels, the run-through being carried out automatically. This is the system that has been used by Talgo trains since 1968 and by CAF trains since 2003, and it has given rise to new developments, the appearance of gauge changers and a genuine revolution in railway service operation systems.

These are the systems analysed in this document, and so we will now describe the most important characteristics of compatible rolling stock and the services they provide.

---

---

## **Variable gauge Talgo trailers**

---

The first trains to provide regular service with the automatic changeover system are the trailers of the Talgo trains with gauge changeover technology: firstly, since 1969, the Talgo III RD (“Rodadura Desplazable” - “Variable Gauge”) and subsequently various versions of the Talgo Pendular (5<sup>th</sup> generation, from 1981; 6<sup>th</sup>, from 1988; and 7<sup>th</sup>, since 2000). These trains have passed through gauge changers tens of thousands of times, the locomotives always being replaced at the border. They have been used since 1969 for international traffic and, since 1992, also for national services that partially use the high-speed lines.

Given that the earlier description of the history and evolution of gauge changers included an overview of these facilities and their functions, we will now focus on some of the technical and commercial characteristics of the trains and their specific services.

### **Talgo RD (Variable Gauge) Trains**

---

The Talgo RD (“Rodadura Desplazable” - “Variable Gauge”) trains constructed between 1969 and 1974 are technically similar to the Talgo III trains (with which they also share the silver and red stripe exterior), which has often led them to be called “Talgo III RD”.

The Talgo RDs are articulated trains formed of short trailers (11.1 metres) that share, two by two, a wheelset with independent wheels. However, unlike the Talgo III, they can change track gauge, passing from the Iberian gauge to the standard gauge or vice versa; and in keeping with this feature, they fall within the international “UIC” clearance gauge instead of the Renfe clearance gauge and are therefore narrower.



Talgo RD en Portbou

Five Talgo RD train sets were constructed, two of them with seats (1969) for the Barcelona-Geneva “Catalán Talgo”, and another two with sleeping berths (1974) for the Barcelona-Paris “Barcelona Talgo”. The end cars (with one axle and two axles), restaurant cars and cafeteria cars are identical for both types of train, and therefore five units of each of these types of vehicle were manufactured.

In total, 35 first class coaches (17 seats) were constructed, but 22 of them were converted into second class coaches (with 25 seats) in 1982, given that the TEE trains originally consisted only of first-class coaches. Five cafeteria trailers, seven 7 restaurant cars, 10 generator vans (half of them with two axles and the other half with one axle), eight trailers with two-berth compartments, and 26 trailers with four-berth compartments were also constructed. All the coaches are 11.1 m long and 3.28 m wide.



Talgo III RD

These trains are autonomous, and can therefore be hauled by any type of locomotive, since the auxiliary services are fed from the generator vans situated at the ends of the train. The train’s first axle is guided by the locomotive, and therefore (despite having hook and screw) the buffers of the locomotive that pulls the train must be pre-compressed for guiding. Like all Talgo trains, their composition is variable; trailers can be added to a train set, and various train sets can even be coupled together.

The series III RD trains run at speed of up to 160 km/h in Spain and up to 140 km/h in France.

The train sets with seats provided the “Catalán Talgo” service from Barcelona to Geneva (changing gauge and locomotive at Portbou) from 1<sup>st</sup> June 1969 to 31<sup>st</sup> May 1995, the date on which (coinciding with the introduction of the TGV

service from Geneva to Montpellier) the route was shortened to Montpellier, although the frequency was immediately increased as the two train sets with seats started to provide a daily service from Barcelona to Montpellier and from Valencia to Montpellier, respectively. The latter-mentioned service was replaced in 1998 by the extended Talgo “Mare Nostrum” service (Cartagena to Montpellier via Portbou), while the Barcelona-Montpellier route continues to be served to this day by a single surviving Talgo train set with seats. In the late 1990s, the second train set began to be used for reinforcement services on national routes, and then for the Madrid to Plasencia and Badajoz service, before being withdrawn in 2003 and transferred to the Museu del Ferrocarril de Vilanova (Vilanova Railway Museum), which preserves it in Can Tunis (Barcelona).

The two Talgo RD sleeper train sets provided the Barcelona-Paris service from 1974 to May 1991 (when, as we have already mentioned, they were replaced by series 6 Talgos). They were then used for regular services from Barcelona to Málaga and, after a period on standby, they were eventually scrapped in the year 2000.

## **Talgo series 5**

---

When the second international Talgo sleeper train (which would link Madrid with Paris) was introduced in 1981, the Talgo Pendular (TPN, “Talgo Pendular Nacional” series 4, an evolved version of the Talgo III) was already running on national routes. The Talgo Pendular had somewhat longer trailers (13.14 m), technical and comfort-related improvements and, above all, allowed for greater speeds on curves thanks to its natural tilting system.

Consequently, when the train sets for the Madrid-Paris Talgo sleepers were constructed, they were no longer based on the Talgo III, but on the new Talgo Pendular, giving rise to the Talgo series 5, which is a variable gauge Talgo tilting train. Only three series 5 train sets were manufactured for this Madrid-Paris service, all of which ran daily on this route from May 1981 until May 1991, when they were replaced by new series 6 train sets.

Cafeteria cars, restaurant cars, tourist class sleeping cars (six four-berth roomettes), club class sleeping cars (six two-berth roomettes) and “grand class” sleeping cars (five two-berth roomettes with bathroom) were manufactured. There are two types of generator vans: one for the single-wheelset coach with two 180 A motors, and another for the two-wheelset coach with a single 300 A motor, as well as a passageway for access to the other train set.

After abandoning “their” original Madrid-Paris service they provided the national night service from Barcelona to Seville via Valencia (“Talgo Mediterráneo”) and, from June 1992, the same service but on the Madrid-Seville high-speed line (“Talgo Antonio Machado”). Since the year 2000, the coaches of these train sets, mixed with the coaches of series 6 and some of series 4, constituted the “Antonio Machado” overnight service from Barcelona to Seville (which from 2000 to early 2009 passed through Valencia), and the “Gibraltar” Tren Hotel from Barcelona to Málaga and Granada.

In January 2009, these Barcelona-Seville and Barcelona-Málaga night services started running again on the high-speed lines from Barcelona to Zaragoza and from Madrid to Córdoba and Seville. During 2009, these trains were replaced by Talgo Camas (Sleepers) series 7 rolling stock, the series 5 and 6 sleeping cars (with certain interior décor improvements) being transferred to the Barcelona-Gijón service that runs on the high-speed line between Barcelona and the Zaragoza gauge changer.

The series 5 Talgo sleeper trains ran at 160 km/h in France (between 1981 and 1991) and in Spain they run at 180 km/h and on type B curves, due to the fact that they are tilting trains.



Talgo Camas class 5

## **Talgo series 6 trains**

---

The daytime (seats only) version of the series 6 Talgo Pendular started running on national routes in 1988. This was an upgraded version of the series 4 Talgo Pendular Nacional (TPN), but now with movable wheelsets for gauge changeover, as well as other technical improvements such as automatic door closing, making them suitable for running at 200 km/h.

Daytime and sleeper train sets were manufactured. The sleeper trains entered into service on the Barcelona-Berne route in 1989 (and then to Zurich and Milan), and also replaced the Talgo RD and the series 5 Talgo on the night services from Barcelona to Paris and from Madrid to Paris, respectively (services they continue to provide today, operated by *Elipsos*).

The daytime trains, after providing various national services, started their variable gauge services in 1992, including the “Talgo 200” services from



Madrid to Málaga and then to Cádiz, Huelva and Algeciras, as well as the long-lived Talgo Triana from Barcelona to Seville and Cádiz. At present (2009), these trains provide the “Altaria” services with gauge changeover from Madrid to Granada and Algeciras and from Cartagena to Montpellier.

The short (13.14 metres) coaches are joined together with a Talgo wheelset shared between each pair of adjacent coaches. The end coach has its own wheelset besides the shared one, and therefore certain coaches are (incorrectly) referred to as “twin-axle” coaches. The series 6 Talgo trains have an autonomous power supply for auxiliary services provided by diesel-alternator power units installed in the end vans of the train set. Each train set can have different sizes (five coaches being the minimum for revenue operation) and various train sets can be coupled together.

The following series 6 coaches have been manufactured: second-tourist class (36 places in 2+2), second class-rear (24 places), club class (26 in 2+1), cafeteria, restaurant (30 places), tourist sleepers (5x4), single double sleepers (6x2) and “grand class” sleepers with bathroom (5x2). There are also single-axle and twin-axle generator vans.



Talgo class VI providing the Fuengirola-Madrid service (Photo: Juan Jose Romero)

## **Talgo series 7 hauled trains**

---

In the year 2000, Talgo made a number of additional technical improvements to its tilting coaches, including pressurization, underfloor air-conditioning systems (allowing the floor to be raised) and better insulation. These new coaches (series 7) can run at a maximum speed of 250 km/h, and their exterior dimensions are identical to those of series 4, 5 and 6). In their daytime version, they started running in the summer of 2000 between Madrid and Barcelona on the conventional line in fixed nine-coach train sets, 22 train sets having been purchased initially.

Following the acquisition of additional coaches at the beginning of 2006, the existing train sets came to be formed of 11 coaches, thereby increasing their capacity to 299 places, and five additional train sets were also incorporated.

Instead of a motor-alternator unit to provide autonomous power supply to the auxiliary services, these trains have static converters situated in the two end coaches, and therefore they have to receive electricity at 3,000 V from the locomotive for this purpose. This is why these trains have not been used on non-electrified lines (the electricity required for the auxiliary services reduces the diesel locomotive's power for traction), although on occasions they have been used on the Madrid to Granada, Algeciras or Almería route. The need to disconnect and reconnect the auxiliary circuit sleeve when changing the locomotive at the gauge changer has meant that these hauled trains take about five minutes longer to pass through the changers than the series 6 trains.

In services involving partial use of high-speed lines (and, therefore, gauge changeover), the series 7 hauled trains have run from Madrid to Barcelona (2003-2006), to Pamplona (since 2003), to Logroño (2003-2006), to Hendaya (2006-2008), to Cádiz (2006-2009) and to Granada (2006-2007), as well as from Barcelona to Cádiz (2006-2008).

Different versions of the series 7 daytime coaches were manufactured: club class (26 places in 2+1), accessible club class (23 in 2+1), tourist class (36 in 2+2), cafeteria, end club class (14 places) and end tourist class (20 places).

In 2007, these coaches (27x11) began to be gradually incorporated into the new series 130 self-propelled trains, which now had two power cars, one at each end. Consequently, they stopped running as hauled trains in June 2009, their last services of this type being those from Cádiz and Huelva to Madrid.



Talgo series VII. (Photo: Justo Arenillas)

## The Talgo XXI train

The next natural step in the development of track gauge changeover systems was to introduce gauge changeover for driving axles, whereby locomotives would also be able to pass through the gauge changers, which in turn would significantly reduce run-through times, changeover process costs and the need for locomotives.

Talgo developed a motor bogie capable of changing track gauge, which was installed in a diesel locomotive with a very original architecture: at the front it had a variable gauge bogie and at the rear a Talgo wheelset shared with the first coach (hence its name: “BT”, or Bogie-Talgo).

This diesel locomotive, coupled to some test coaches to form a silver-coloured train called “Talgo XXI”, completed numerous test runs from 1998 onwards, including a journey from Madrid to Puente Genil in 1999. Shortly afterwards, a second locomotive of the same characteristics was added to form an M-3R-M train set (locomotive-3 trailers-locomotive).

These two locomotives were acquired, together with four intermediate coaches and two trailer cars with cab, by the Railway Infrastructure Manager (Gestor de Infraestructuras Ferroviarias, GIF), which used them to test the dual gauge changer at Río Adaja and the new system of three-rail tracks with two gauges. They also underwent various tests on the Madrid-Barcelona line, in which they set a new world speed record with diesel traction in June 2002 (over 256 km/h) near Lleida.



The two Adif-owned Talgo XXI trains at Roda de Bará (Photo: Sergio López Lara)

---

## The TRDs with CAF “Brava” bogie

---

CAF also developed a motor bogie capable of changing gauge with a similar technology, which it called “Brava”.

The system basically consists of two sets of wheels which rotate over bushings and can be pre-set to shift sideways over a non-rotating axle. The separation between wheels is determined by the position of the bushings above the axle body. An automatically operated locking-unlocking mechanism allows them to reach their position. In the case of the drive axles the gauge differences are absorbed by hollow shafts which join the reducer to the wheels, and in the case of the trailers axles they are absorbed by the wheels.

The bushings are immobilized by locking dowels, thus preventing sideways movement while the train is running. To unlock them it is necessary to completely unweight the wheels. There is also an additional safety device - the catch-, without which the bushings cannot be moved. Functionally, the Brava behaves in a similar way to a conventional axle, with coupled wheels that rotate. The arrangement of the brake elements is such that their position is not modified by the gauge changeover, which simplifies the operation. The drive axles and non-driving axles are very similar, the only differences being due to the reducer that is installed in the drive axle and the drive shaft that connects it to the motor situated under the vehicle body.

In the Brava system, the gauge changeover operation begins automatically by deactivating the safety device and unweighting the wheels by means of the rollers situated under the support bodies on some guide rails. The wheels and the axle body then descend and the locking cones are released. The wheels are then moved sideways between the two gauges, pushed by the guide rails, and then lifted until the cones are relocked in the new position. The wheels recover their load, the guide rails disappear and the safety device is reactivated.

A series 594 TRD (Regional Diesel Train) equipped with this type of bogie started undergoing tests on the GIF's Olmedo-Medina del Campo test section in the year 2000.

Renfe's "TRD" series 594 comprises 23 two-coach diesel trains that derive from the Danish ICE3s. Their total power output is 1,080 kW (4 300 kW Man motors), each one has 136 places in a single class, and their maximum speed is 160 km/h.

After the successful tests, two Brava-equipped trains of this series (renumbered as 594.201 and 202) started to provide revenue service at the end of 2003 between Catalayud, Zaragoza and Jaca, covering part of their route on the Madrid-Barcelona high-speed line. This route was shortened in 2006 (Zaragoza to Jaca).

Subsequently, these trains (always based in Zaragoza) were transferred to Iberian gauge services following the introduction of the Avant service with series 104 electric trains between Zaragoza and Huesca.

---

---

## **The Talgo-Team locomotive**

---

Talgo development was geared toward the variable gauge electric motor bogie, and therefore a consortium led by Talgo (who also constructed the mechanical part), and which included two other companies (Ingelectric and Team), constructed a variable gauge locomotive capable of reaching a speed of 260 km/h, which started undergoing tests at the end of 2003.

At the end of December 2003, bogies were fitted in this first variable gauge electric locomotive, which served as a prototype for the series of 90 vehicles that Renfe had acquired to form "self-propelled" series 130 train sets with 7<sup>th</sup> generation Talgo trains. This locomotive is dual-voltage and has a power output of 3,6 MW.



Truca locomotive at Plasencia de Jalón

This prototype locomotive (which Talgo called “Virgen del Buen Camino”, nº L9202 and 130.901) is somewhat different from the series locomotives, given that it has two driver’s cabs (the series locomotives only have one cab because they are permanently coupled at each end of the train), and it also differs from the BTs (since besides being electric instead of diesel, it has two bogies and can be coupled to the trains with hook and tensor). Another difference in relation to the series locomotives is that the electrical system has a different design and manufacturer.

The locomotive has a mass of 74 t (18.5 t per axle); it has two bogies, each one with two axles, and each axle is driven by an asynchronous three-phase electric motor. It can be fed at 25 kV in alternating current or at 3 kV in direct current, and it has four pantographs (two of each voltage), regenerative electric brake and Ep brake control for the train.

The manufacturer is a consortium led by Talgo (who also constructed the mechanical part), and the electrical part was constructed by Ingelectric and Team.

The locomotive is equipped with LZB and ASFA and is prepared for ETMS. It has analogue ground-train communication and GSM-R and can feed the train’s auxiliary services through a high-voltage line.

To perform the tests, Talgo created a train set consisting of tilting trailers from different series, including the tilting head-end unit that formed part of the Talgo Pendular test train. Both the locomotive and the trailers are painted in grey and dark crimson.

---

## **Talgo freight wagons for gauge changeover**

---

In 1994 Talgo began to consider the possibility of applying the variable gauge (RD) system (which had been functioning in Talgo wheelsets for years) to axles, in order to be able to use it in conventional coaches, freight wagons and even in locomotives.

The idea was to develop an axle with the RD system that could be applied either directly to the axle wagons or to a bogie. Once the system had been developed and patented, four axles were constructed and installed in two wagons, along with 12 axles which are used in six Y25 bogies and which in turn are mounted in three wagons. The axles can be applied to Y25 bogie frames (for 1,668 y 1,435 mm track gauge) and to the Y 21 bogie (for 1,435 and 1,520 mm), without having to make any changes in the frame or structure of the bogie (although, logically, it is necessary to adapt the brake rigging).

In 1999, these vehicles clocked up 80,000 kilometres on Spanish lines, both conventional (from Madrid to Majarabique via Despeñaperros) and high-speed (1,435 mm track gauge, between Majarabique and Seville) after passing through the Majarabique gauge changer.



---

## **The CAF series 120 high-speed train and its offshoots**

---

In response to Renfe's call for tenders in 2000 for the procurement of the first self-propelled trains, CAF submitted what turned out to be the winning bid: a 107-metre-long four-coach electric train with a power output of 4,000 kW and a maximum running speed of 250 km/h (series 120). It can also run on lines with both track gauges (1,435 and 1,668 mm), operate at 25 kV in alternating current or at 3 kV in direct current, and has four pantographs. This train is equipped with "Brava" bogies.



Two series 120 electric trains providing the Alvia service from Madrid to Barcelona pass each other on the outskirts of Vilanova i la Geltrú (Barcelona) on 3rd July 2007. (Photo: Gonzalo Rubio)

Renfe initially purchased 12 units of this train, which entered into service in March 2006 between Madrid and Barcelona under the commercial name “Alvia”, using the new high-speed line from Madrid to the changer at Puigverd (Lleida) and, from December 2006, to the Roda de Bará changer. It was then that they set a new journey time record on the Madrid-Barcelona railway route: 3 hours and 55 minutes. The new train passes through the gauge changer without stopping, only having to reduce its speed to about 15 km/h. As soon as the complete Madrid-Barcelona line entered into operation (20<sup>th</sup> February 2008), the series 120 trains started running from Madrid to Pamplona (4 services a day, one of them extended to Hendaya), to Logroño via the Plasencia de Jalón changer, and then from Barcelona to Vigo and from Barcelona to Bilbao and Irún - Hendaya. They have also provided service without gauge changeover on the Madrid-Valencia route.

The series 120 train offers a total of 238 places. It is 107 metres long and weighs 271 tons.

### **Trains derived from CAF series 120**

In 2004, Renfe acquired 45 more series 120 units with an eye on the expansion of high-speed lines, but the contract was renegotiated in 2005 and the order was divided into two:

- 29 trains belonging to the new series 121 for variable gauge medium-distance services (with some differences in relation to the original trains, such as one class only and no cafeteria car). These trains entered



into service in the early months of 2009 on the Avant route from Madrid to Valladolid and Segovia, no gauge changeover; and since October 2009 regularly attend the route Jaén-Córdoba-Sevilla, changing the gauge in Alcolea, near Córdoba.

- 16 more trains for long-distance services, very similar to those of the first purchase, forming the subseries 120.500

---

---

## **The Talgo 250 high-speed train (series 130)**

---

The results of the diesel BT and Talgo-Team Travca locomotive tests gave rise to the construction of the 90 power cars of the series 130 electric train, which is formed of two electric power cars and a variable number of Talgo 7<sup>th</sup> generation trailers (11 coaches with 299 places in the first version). This train can reach speeds of up to 250 km/h.

It began to provide revenue service in October 2007 on the Madrid- Gijón and Gijón-Alicante routes on the conventional line, and started running on the Madrid-Valladolid high-speed line when this line entered into operation on 23<sup>rd</sup> December 2007. Since that day, these series 130 trains have been providing the following services: Madrid to Gijón, Santander and Bilbao, and Alicante to Gijón and Santander. They change gauge at Valladolid Campo Grande and, in the case of the trains heading to Alicante, at Madrid Chamartín.

A new frequency from Madrid to Gijón, and another from Madrid to León, has subsequently been introduced on this line. On the Iberian gauge line they run from Madrid to Alicante and Valencia, and from Valencia to Barcelona (where they have gradually been replacing the series 101 trains on the “Euromed” services).



Talgo series 130 variable gauge train on high-speed line

## Passenger services with variable gauge trains

In the spring 2008 timetable, the variable gauge passenger trains (Alvia, Altaria, "Talgo 200" and TrenHotel) running in Spain on two networks (and therefore changing track gauge) are the ones included in the table, which distinguishes between (daytime and overnight) international services and national high speed services (at that time there were no TrenHotel running partially on high-speed lines, as they had done up until the year 2000 and again as from January 2009).

As can be seen, these trains cover an average distance of 463 kilometres on standard gauge lines and 279 kilometres on Iberian gauge lines, taking an average time of 11 minutes to change gauge.

The average speed of the national high-speed trains is 170.5 km/h on high-speed lines (1,435 mm track gauge) and 80 km/h on conventional lines (Iberian track gauge). The average speed including the time taken in the changer is 115.2 km/h.

### Passenger services with track gauge changeover (2006-2008)

Ruta	Periodo	Material	Frec. (IV)	Cambiador (es)	Recorrido en ancho estándar (km)	Tiempo ancho estándar (h:min)	Tiempo en cambiador (h:min)	Recorrido en ancho ibérico (km)	Tiempo ancho ibérico (h:min)	Tiempo total (h:min)
<b>Internacionales</b>										
Barcelona-(Ginebra) Montpellier "Catalan Talgo"	1/6/1969-	Talgo RD	2	Portbou	170,7	1:59	0:15	167,0	2:17	4:31
Madrid-Paris ("Francisco de Goya")	1981-	Talgo 6	2	Irún	813,3	6:30	0:15	640,9	6:42	13:27
Barcelona-Paris ("Joan Miró")	1974-	Talgo 6	2	Portbou	845,7	9:25	0:13	167,0	2:17	11:55
Barcelona-Milán ("Salvador Dalí")	1992-	Talgo 6	1	Portbou	687,3	11:14	0:13	167,0	2:17	13:44
Barcelona-Zurich ("Pau Casals")	1992-	Talgo 6	1	Portbou	826,9	11:25	0:13	167,0	2:17	13:55
Cartagena-Montpellier ("Mare Nostrum")	1986-	Talgo 6	2	Portbou	170,7	2:12	0:13	851,0	10:09	12:34
<b>Media internacionales</b>					<b>585,8</b>	<b>7:07</b>	<b>0:13</b>	<b>360,0</b>	<b>4:19</b>	<b>11:41</b>
<b>Nacionales alta velocidad</b>										
Madrid-Barcelona ("Alvia")	2003-2008	s120	16	Roda de B.	535	3:51	0:00	67,0	0:49	4:40
Barcelona-Cádiz (Altaria "Triana")	1992-2008	Talgo 7	2	Roda y Majarab.	997,5	2:51	0:15	233,1	7:01	10:07
Madrid-Pamplona (Altaria)	2003-	Talgo 7	8	Plasencia de J.	275,6	1:38	0:15	187,0	1:37	3:30
Madrid-Logroño (Altaria)	2003-	Talgo 6	2	Plasencia de J.	275,6	1:47	0:15	151,0	1:38	3:40
Madrid-Málaga (Talgo 200)	1992-2007	Talgo 6	12	Antequera S.A.	455,2	2:42	0:15	70,0	0:50	3:47
Madrid-Algeciras(Altaria)	1999-	Talgo 6	4	Antequera S.A.	455,2	2:42	0:15	176,0	2:28	5:25
Madrid-Granada (Altaria)	2006-	Talgo 6	8	Antequera S.A.	455,2	2:42	0:15	131,0	1:39	4:36
Madrid-Jerez-Cádiz (Altaria)	1993-	s130	4	Majarabique	462,5	3:10	0:15	166,1	2:02	5:27
Madrid-Huelva (Altaria)	1993-	s130	2	Majarabique	462,5	3:10	0:15	107,0	1:26	4:51
Madrid-A Coruña/Pontevedra (Talgo)	2008-	Talgo 6	2	Valdeillas	160,9	1:10	0:14	598,3	6:43	8:07
(Alicante)-Madrid-Santander (Alvia)	2007-	s130	8	(Mad.Ch)-Valladolid	179,4	1:16	0:00	264,3	3:09	4:25
(Alicante)-Madrid-Gijón (Alvia)	2007-	s130	6	(Mad.Ch)-Valladolid	179,4	1:16	0:00	341,1	3:49	5:05
Madrid-Valladolid-Bilbao (Alvia)	2007-	s130	2	Valladolid	179,4	1:22	0:00	311,8	3:24	4:46
Madrid-Valladolid-Irún-Hendaya (Alvia)	2007-	s130	2	Valladolid	179,4	1:22	0:00	391,0	3:30	4:52
<b>Media nacionales alta velocidad</b>					<b>375,2</b>	<b>2:12</b>	<b>0:09</b>	<b>228,2</b>	<b>2:51</b>	<b>5:14</b>
<b>Media todos trenes ancho variable</b>					<b>463,3</b>	<b>3:59</b>	<b>0:10</b>	<b>279,3</b>	<b>3:25</b>	<b>7:36</b>
					<b>Linea ancho estándar (km/h)</b>	<b>Linea ancho ibérico (km/h)</b>	<b>Recorrido total (km/h)</b>			
<b>Velocidades medias</b>										
Velocidades medias trenes internacionales (km/h)					82,4	83,7	81,0			
Velocidades medias trenes nacionales alta velocidad (km/h)					170,5	80,1	115,2			
Velocidades medias todos los trenes (km/h)					116,4	81,4	97,7			

Source: Independently produced

The national variable gauge daytime services go by the commercial names of *Alvia* (those formed of self-propelled trains) and *Altaria* (those which are hauled by locomotive), whereas the overnight services are called *TrenHotel*.

Regional services to gauge change (in November 2009 only Jaén-Cádiz) were nominated "AV-Shuttle". These services link (in August, 2010) Madrid with A Coruña, Vigo-Pontevedra, Gijón, Santander, Logroño, Pamplona, Granada, Algeciras, Cádiz and Huelva; and Barcelona with Vigo, A Coruña, Bilbao, Irún-Hendaya, Pamplona, París, Zurich, Milan, Montpellier; and Jaén with Cádiz.

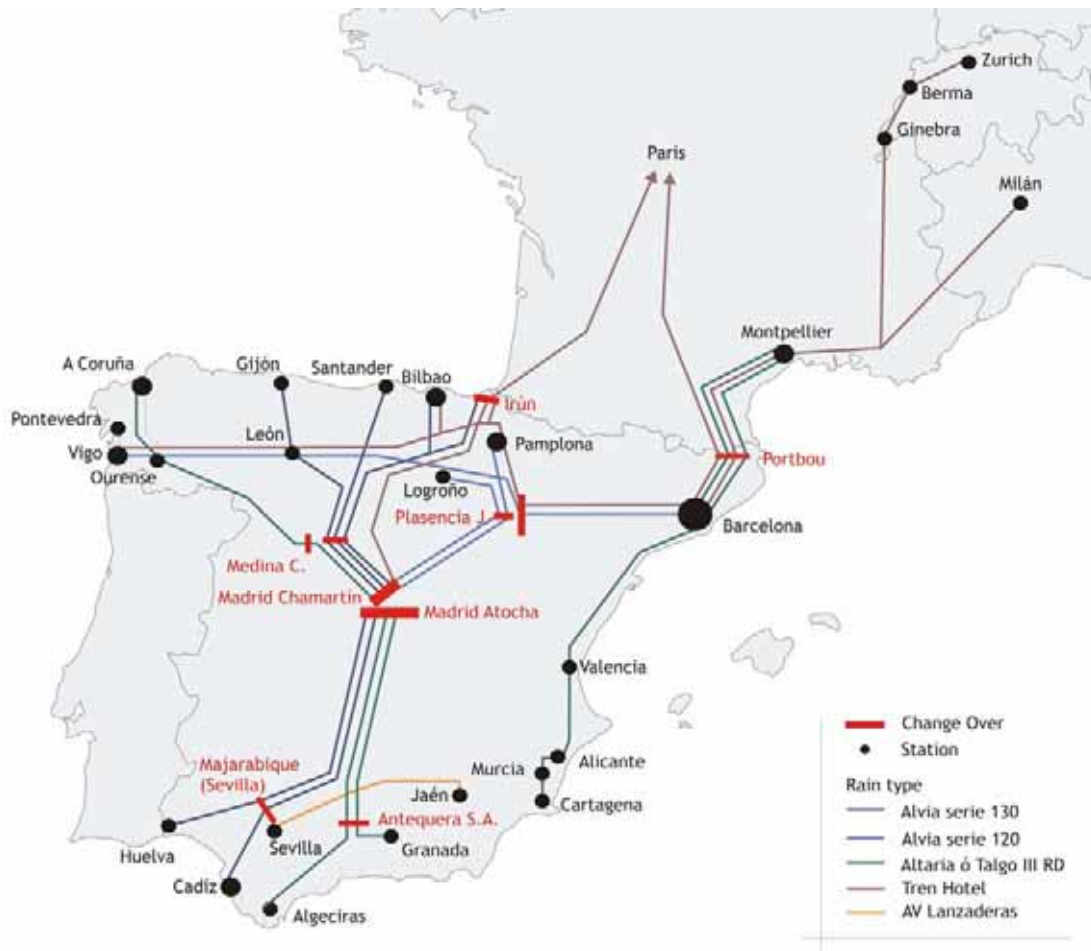

Variable gauge services in 2010

The fact that the trains can cover part of their route on the high-speed lines extends the benefits of the high-speed network to other towns and cities apart from those situated on the line itself.

To be precise, while there are only 20 high-speed line stations, a total of 75 stations have high-speed services thanks to the variable gauge trains.

## Automatic track gauge changeover for trains in Spain

Alberto García Álvarez



There are 20 high-speed line stations and another 75 on conventional lines that receive high-speed trains thanks to the variable gauge



# GAUGE CHANGEOVER R+D+i. OPPORTUNITIES, PROBLEMS AND PROSPECTS

In Spain, the existence of automatic track gauge changeover systems for trains has allowed the railway to capture a significant volume of passenger traffic that it would have lost had this type of installation not existed, either due to rejection of transfer (international trains) or because it would not have been possible to take advantage of certain sections of high-speed line, and therefore journey times would have been longer than those achieved with the gauge changeover systems.

These figures are significant, but they are destined to increase considerably in the coming years, for various reasons:

- Variable gauge self-propelled trains (Renfe series 120, 121 and 130) are able to pass through the changer much more quickly and can also run on high-speed lines at speeds of up to 250 km/h, which allows them to offer more competitive journey times. They are high-speed trains that have just joined the fleet (there were only 12 series 120 trains in service at the end of 2006; there will be 102 series 120, 121 and 130 trains in service by the end of 2009).
- The gradual expansion of high-speed lines, especially those from Madrid to the North and from Madrid to Levante, which will take many years to complete, suggests the ongoing advisability of partial use of high-speed lines combined with conventional lines to reach certain final destinations.
- The possible gradual transformation of the track gauge in the Spanish conventional network (viability studies are being carried out for this purpose) will lead to the appearance of new gauge borders - in some cases temporary and in others permanent - for which variable gauge trains will offer unique operation opportunities.
- Finally, the foreseeable increase in freight traffic on international routes - in its conventional, intermodal and “rolling highway” versions - , suggests the advisability of these changers being able to offer rapid and economical alternatives for routing these goods and avoiding transshipments or the axle changes that are sometimes excessively slow and whose cost exceeds that of transshipment.
- Talgo has announced (2009) that it is ready to manufacture a prototype variable gauge train capable of running on high-speed lines at 300 km/h, and CAF also expects to be able to reach this speed in its new AVI-2015 high-speed trains.

However, these opportunities also entail certain problems, such as the following:

- Many changers will be of a temporary nature (even if they deal with a significant volume of traffic during a sometimes brief period of time).
- The duality of passenger train gauge changeover systems has the disadvantage of needing more space and installations to make the two systems compatible.
- The possibility of using automatic changeover systems in freight trains not only opens up the possibility of using Talgo “RD” wheelsets or CAF “Brava” bogies for freight wagons, but will also allow trains with other technologies to enter Spain.



Power car of the Talgo variable gauge prototype capable of reaching 300 km/h. CAF has announced the launch of a similar train.

The need to take advantage of these opportunities and solve the associated problems has given rise in Spain to a line of Research, Development and innovation, whose first results, both in installations and in rolling stock, have already been described in this document, and which is progressing at a healthy pace in both fields.

A basic idea of these developments is that the diversity of systems should not multiply the number of gauge change installations, given that these installations require a lot of space in places where such space is not always easy to find; and moreover, the switches and interlocks for access to these changers are extremely expensive (much more so than the changers themselves). Therefore, an effort has been made to concentrate the installations in single changers through which trains of two or more technologies can pass. The infrastructure manager wants to allow trains of all technologies to use the changers, but space restrictions have necessitated this line of research.

Furthermore, the singularity of these installations has meant that changers have traditionally been implemented as isolated units, so that various tracks (two on a double-track line, or more at a passenger station or marshalling yard) converge toward a single changer. Oddly enough, this solution, contrary to what one might assume, is more costly than that of increasing the number of changers, since the latter solution reduces the number of switches and interlocks, while also offering the advantage of greater capacity. However, if each changer is based on a single technology, the desirable increase in capacity does not occur.



We will now describe the current situation as regards the latest developments in Spain relating to automatic track gauge changeover for trains and improvements in the trains themselves.

---

---

## Dual changers for two technologies (TCRS 1, TCRS 2 y TCRS 3)

---

---

The similarity between the Talgo and CAF gauge changeover technologies has permitted increasing convergence between the two changers: initially with the previously described dual changers - both the fold-away model (TCRS 1; Río Adaja, 2000) and the horizontal movement model (TCRS 2; Valdestillas, 2007) -, and more recently with the single-platform changer (TCRS 3, patented in 2007, experimental installation at Roda de Bará, 2009).

### TCRS-1: Talgo and CAF fold-away changers

---

In the TCRS 1 fold-away changer, each platform (Talgo or CAF) turns 90° around an axis parallel to the longitudinal axis of the track with oil-hydraulic interchange system.

---

Dual changer TCRS 1

---

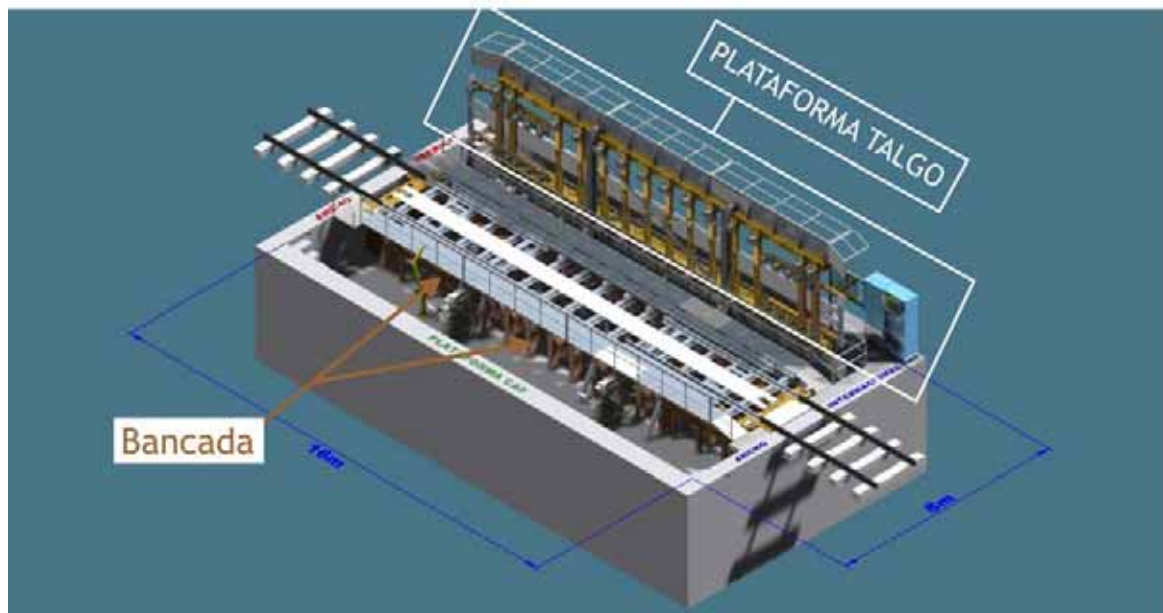

Source: TRIA

---

This changer needs a width of only 8 metres, but requires moving a total mass of 27.140 tons including hydraulic arms and supports, the force needed in the hydraulic cylinders to change the platforms being 80,400 daN x 2 cylinders = 160,400 daN, and the power output needed to change them being 20 kW.

Changers of this type have been installed at Río Adaja (2000, dismantled in 2008 and its platforms transferred to Medina del Campo), Plasencia de Jalón (2003), Zaragoza Delicias (2003), Roda de Bará (two changers, 2006), one of them dismantled in 2008), Antequera-Santa Ana (two changers, 2006) and Valladolid-Campo Grande (2007).

## **TCRS-2: Talgo and CAF horizontal platforms**

As an evolution of the fold-away dual changer, Adif designed and patented the “horizontal changer”, in which Talgo’s platform is replaced by CAF’s (and vice versa) by means of the horizontal movement of both platforms (the interchange system is also oil-hydraulic in this case).

### Dual changer TCRS 2

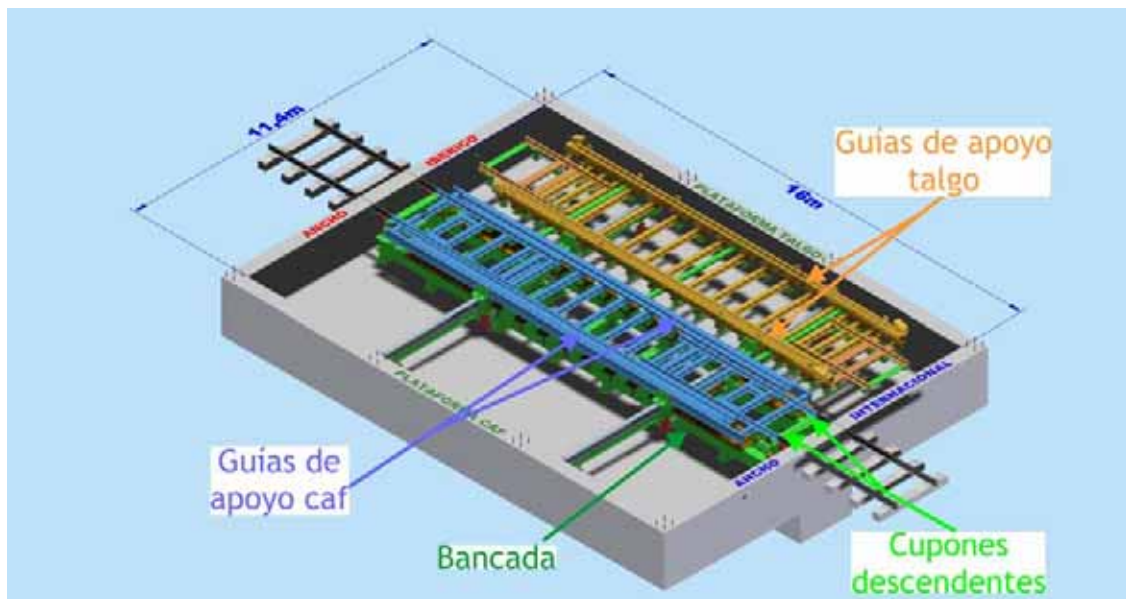

Source: TRIA

This changer requires a slightly wider space, 12 metres to be precise, but the movement is simpler, and therefore the changer is easier to use, more reliable and more economical.

In this case, the total mass is 23,982 kilograms, including supports. The maximum force needed in hydraulic cylinders to change the platforms is 2,280

daN (1,140 kg x 2 cylinders), the power output needed to change the platforms is 5 kW, and the platform change operation takes 6 minutes.

Changers of this type have been installed at Madrid-Chamartín (2007), Valdeillas (2007), Medina del Campo (2008) and Alcolea de Córdoba (2009).

### **TCRS 3: Talgo and CAF single platform**

The next step involved designing a single changer for the Talgo and CAF technologies that, without needing to change platforms, would cater for block trains of both technologies.

#### **Dual changer Talgo-CAF 3**

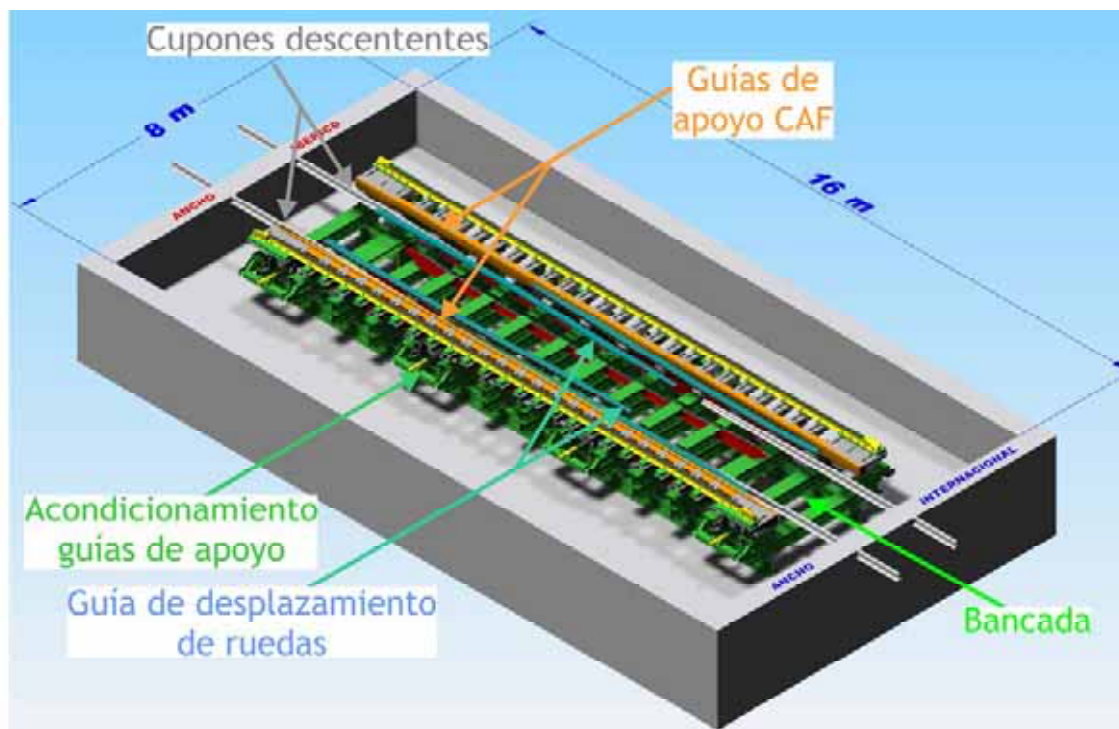

Source: TRIA

These changers (which belong to the fourth generation of changers) would be especially useful in places where only passenger trains of these technologies were expected to pass through.

As some of the support and guide elements are different and interfere with the clearance gauges of one type of train or the other, the changer allows both types of train to pass through by lowering the Talgo locking devices when the CAF train passes through and shifting the guide rails of the Talgo train.

The interchange system is oil-hydraulic and electric. The parts that have to be moved are neither numerous nor heavy (barely 5,400 kg), and they only need to be moved over very short distances. Moreover, the resistant parts that have to be moved (the Talgo train guide rails) can be moved sideways, and only the locking devices, which do not have a resistant function, are moved vertically.

The maximum force for platform change is 650 kg, the power output needed to change the platforms is 1.5 kW, and the platform change operation takes only 15 seconds.

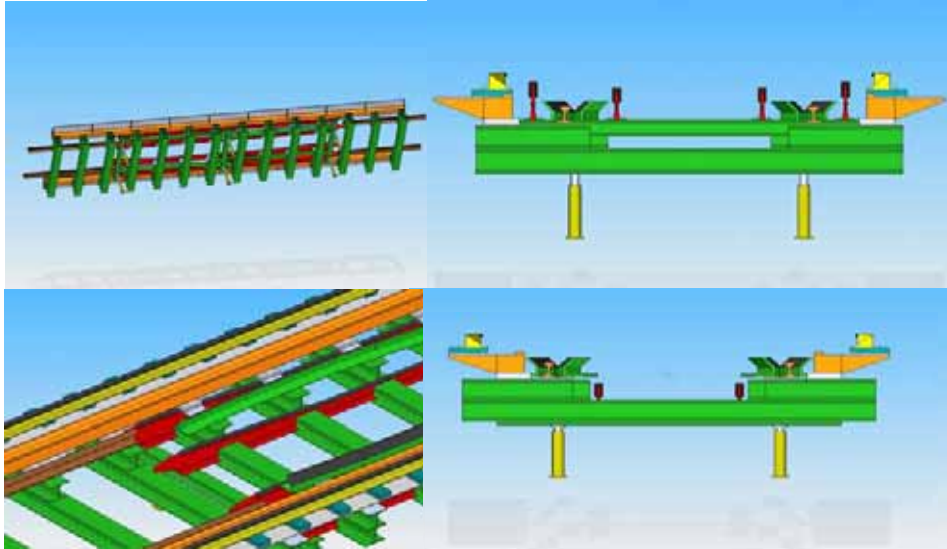

Talgo-CAF single changer for block trains (TCRS 3). Source: TRIA

---

---

## Changer for up to four technologies in the same train (TCRS 4)

---

Once the Talgo and CAF systems had been incorporated into a single changer, the next logical step was to integrate this changer with the systems developed by the Polish and German national rail companies, which already had a single changer for both technologies. These systems are the Polish SUW 2000 and the German DBAG/Rafil “Typ V”, which gave rise to the development of the TCRS-4 changer patented by ADIF in 2008.



Changer for Rafil and SUV-2000 technologies installed at Irún for tests

### Functionality of the TCRS-4 changer

The TCRS-4 system (which can also be included in the fourth generation) integrates the four technologies into a single changer, allowing trains with axles equipped with the four technologies to pass through without stopping, the gauge of all the axles being changed in the same changer even if there is a combination of different technologies in the same train.

This changer is modular, and therefore it offers a wide range of possibilities: it can be installed for two, three or four technologies, and it also allows for new technologies to be added as and when they appear.

Moreover, a pair of track gauges can be pre-selected in each changer. In Spain, for example, this would always be 1,435/1,668 mm, but other options are also available, e.g. the Russian gauge (1,435/1,520 mm) or the metric and international gauge (1,000/1,435 mm).

The interchange system is oil-hydraulic and electric, the total mass to be moved is 6,100 Kg, the maximum force needed to change platform is 650 daN, the power output needed to change the parts is 5 kW, and the change process takes just one second to complete.

The TCRS-4 changer offers the following advantages:

- Integration of the CAF, Talgo, SUW 2000 and Rafil/DB systems in any of their combinations in a single mechanical assembly.
- Reduction of width space. The system is designed to be installed in a pit with the same width as the track body.
- Mechanical simplicity, since for the different platform configurations it is not necessary to move large masses. Extremely precise and rapidly installed electro-hydraulic movement systems can be used to guarantee the alignment and fastening of the moving guides.
- Economical, as a result of less space being needed, mechanical simplicity and the integration of four systems in a single installation, thus providing a considerable cost saving.

Due to the innovative nature of the TCRS-4 universal changer, its characteristics are described in detail below.

### **Technical characteristics of the TCRS-4 changer**

---

Along general lines, the TCRS-4 universal track gauge changeover device is based on the design of a new set of slide guides, shift check rails, latch activation guides for the Talgo system and latch activation for the SUW 2000 and Rafil/DB systems, so that it can be used with all types of trains, with three preferential positions for slide guides activated by a set of hydraulic-electric mechanisms, retracting the Talgo latch activation guides with a hydraulic-electric system when the configuration is for any of the other three systems, and giving continuity to the running rails so that it can be used by the SUW 2000 and Rafil/DB.

Its modular design makes it possible to integrate two, three or all four of the available technologies, and even a fifth if it existed.

Two changer configurations have been envisaged:

1. In the first configuration, the mechanical assembly remains mechanically locked in the CAF, Talgo, SUW 2000 or Rafil/DB position, allowing pure train sets to pass through.

In this case, when it is necessary to change the position (for example, from the Talgo position to the SUW 2000 position), all the shaft locks, accumulators and cylinders to permit movement are deactivated, which causes a movement, on the axis perpendicular to the track axis, of the assembly formed of slide guides, removing them from the zone of interference, and another movement on the axis perpendicular to the track plane to conceal the latch activation guides; simultaneously, the latch activation guides of the Polish-German system are positioned.

Once all the parts are in their pre-set position, each and every one of them is locked.

The shift check rails are the same for all the train types and they guide the axles gradually with the optimum angle of attack for all types of rolling surface. The length of the platform may vary according to the desired maximum run-through speed, thus changing the angle of these check rails. The running rails of the SUW 2000 and Rafil/DB systems will maintain the angle defined for the check rails in each combination.

2. A second configuration allows mixed trains to pass through, i.e. trains formed of vehicles equipped with various technologies. In this phase, the set of constituent mechanisms is based on the same functionality criteria, but the platform increases its length and divides into two parts, thus adapting its morphology to any of the four systems by zones and in real time, without the train having to stop.

The assembly is equipped with an artificial vision system combined with an axle counter that allows the installation to know at all times which type of axle is going to change gauge. Likewise, it recognises the existence of obstacles in the vehicle's mechanism, producing an emergency stop and communication to the engine driver in the event of an incident. This same system detects the presence of ice in the wheelsets and warns the engine driver in the event of overspeeding.

The moving parts assembly is fixed to a static structure formed of steel sections that are bolted down inside the pit.

The basic characteristics of the structural elements are:

- They must withstand the vertical loads produced by the weight of the platforms and that of the train with the loads increased by the necessary percentage.
- Possible braking forces tangential to the platform in both the longitudinal and transverse direction are also considered.
- The moving systems will be equipped with double mechanical locking to guarantee the gauge of the shift check rails and lock activation guides at all times.
- The assembly will be mounted and perfectly levelled so that there are no level differences between two points in the slide guides with the necessary tolerances for the most demanding case.
- All the parts have been designed to permit rapid replacement without auxiliary equipment.

---

## **Toward a new generation of gauge changers**

---

The long process of development that has taken place over the 40 years since the “Catalán Talgo” made its first journey in 1969 has permitted the evolution of track gauge changeover systems and the associated changers, which can be divided into three “generations”.

The lines of R+D+i undertaken to respond to the latest challenges and opportunities in this field suggest that there will soon be a “fourth generation” of changers. This generation differs from the previous both in terms of modifications in the changers themselves and because of differences in their immediate environment (access tracks, electrification, etc.)

In the future, track gauge changeover systems will have to:

Allow high-speed passenger trains to pass through; the latest generation of these trains will be capable of running at a maximum speed of 300 km/h.

Allow freight trains comprising wagons of various Technologies to change gauge (these trains will be pushed or hauled through the changer by their own locomotive or by another locomotive, but not by gravity).

Therefore, the emergence and spread of self-propelled passenger trains are expected to reduce the need for a “sunken” profile, since even the very long and variable-composition TrenHotels are pushed by their own locomotive. This suggests a tendency toward a more horizontal profile to favour the run-through (especially the exit) of self-propelled trains.

Furthermore, in relation to the changers used exclusively by passenger trains, research is being carried out to determine the advisability of changing the electrification voltage, whenever possible, on sections beyond the limits of the actual changer.

As regards modifications in the actual changers (besides being compatible for various technologies), the following improvements can be highlighted:

- Unification of the Talgo and CAF slide guides for sideways wheel movement, adapting the elastic system of the Talgo guides with an electrical indicator that confirms the movement of the guide (and therefore of the wheel).
- Increasing the length of the slide guide area to one metre, providing a smoother and more gradual angle of wheel attack on the guide rails (this being the point that suffers most in the run-through process), thus increasing the run-through speed. The layout in the slide guide area, instead of being straight, now has a transition curve to ensure a smoother passage, eliminating bumps and jolts.



- To prevent the wheel from jumping out of its guide rail, the system includes (besides early detection by means of the abovementioned sensors situated in the guide rails) some horizontal protective plates parallel to the rail, along which the wheel moves, thus preventing it from falling and sustaining damage and making it easier for the wheel to get back on the rail.
- The existing water cooling system for the TALGO support guides has been replaced by an automatic lubrication system, with grooved guides and automatic greasers, as well as the use of biodegradable lubricants, which resolves the problematic presence of water in contact with the mechanical parts.
- Installation (where the weather conditions make it necessary) of a double de-icing pit on each side, with pre-de-icing system. The first pre-de-icing pit is situated at a distance of approximately 13 metres to permit general pre-heating of the wheelset, thus increasing the capacity of the second pit, whose positioning system would be similar to the one that currently exists, for a more localized de-icing of incrustations in the critical parts and components.

### Gauge changer generations

<b>GENERACIÓN</b>	<b>AÑOS DE IMPLANTACIÓN</b>	<b>CAMBIADOR</b>	<b>TRENES</b>
<b>1ª</b>	<b>(1969-1974)</b>	<b>Talgo en Foso</b>	<i>Trenes viajeros remolcados pasando por frontera</i>
<b>2ª</b>	<b>(1992-2000)</b>	<b>Talgo en Foso</b>	<i>Trenes viajeros remolcado líneas de alta velocidad</i>
<b>3ª</b>	<b>(2000-2009)</b>	<b>TCRS1 y TCRS2</b>	<i>Trenes viajeros remolcados y autopropulsados CAF y Talgo</i>
<b>4ª</b>	<b>(2010- )</b>	<b>TCRS3</b>	<i>Trenes viajeros y mercancías tráfico ibérico</i>
		<b>TCRS4</b>	<i>Trenes viajeros y mercancías todos los tráfico</i>

*En el futuro se instalarán el TCRS3 y TCRS4 (cambiadores de 4ª generación) en cada lugar en función de las necesidades. ("Elaboración propia").*

---

## BIBLIOGRAPHY

Alberto García Álvarez, “Los de Roda y Antequera incorporan todas las novedades: Los cambiadores de ancho, nueva solución a un viejo problema”, Vía Libre, January 2007.

Alberto García Álvarez, “Cambiadores de ancho, trenes de ancho variable y tercer carril: Nuevas soluciones a un viejo problema”, Revista Anales de Mecánica y Electricidad, January-February 2007.

Alberto García Álvarez, “Cambiadores de la línea de Madrid a Valladolid”, Vía Libre, December 2007.

Dirección de Explotación del GIF (2002): “Definición funcional de las instalaciones de cambio de ancho para trenes de viajeros en las nuevas líneas de Alta Velocidad”, December 2002.

Jesús Moreno Fernández, (1986) “Prehistoria del Ferrocarril”, ed.: Vía Libre, Instalments included in the magazine from November 1986 to May 1989.

Juan José Olaizola Elordi (2006): “La nacionalización de 1941, la paradoja de la vía estrecha” in Revista de Historia Ferroviaria, issue no. 4.

Renfe, Departamento de Estudios y reconstrucciones (1955), “Reducción del juego de vía”.

---

## ACKNOWLEDGEMENTS

The author would like to thank to following people for their collaboration: José Luis López Gómez (Patentes Talgo), Luis Terradillos (CAF), Germán Giménez (CAF) Francisco Paños Maglané (Tria), Sergio López Lara (Tria), Moisés Gilaberte (Tifsa), Juan Miguel Sastre (Tifsa), Ricardo Daroca Gallego (Tria), Pedro Lillo Polaina (Tifsa), María Lillo Polaina (Adif), Juan Carlos Ponce (Elypsos), Miguel Jiménez Vega (FFE) and María Pilar Martín Cañizares (FFE). The author also thanks Luis E. Mesa Santos and Leticia García and for helping to edit the document. The photos were taken by the author, Jose María Trigos, Sergio López Lara, Juan Miguel Sastre and Ana López Romero.



## Photographs of automatic track gauge changeover



Test changer TCRS3 in the CAF position. Notice that the Talgo locking devices have been lowered and the guide rails have been moved sideways.



First train of the series 121 (CAF) passing through the test changer on 1st September 2010.

Photos: Sergio López Lara (Tria)

